

CABLES AND WIRES

PRICE LIST & TECHNICAL CATALOGUE

2009

Preface

to the 21st Issue

Markets get faster, customer wishes more individual, technologies more demanding. **MEINHART Kabel** is active in this exciting field as a successful specialist company for the procurement and distribution of cables and wires. High quality, prices in line with market requirements and perfect logistics are our benchmarks. The fulfilment of these criteria will be guaranteed by our certified teams who transmit their well-grounded knowledge to you with pleasure. This catalogue should support you in your daily work.

MEINHART Kabel Österreich GmbH

legal form: private limited company

FN: 299994v Landesgericht Steyr

Westbahnstraße 6

A-4490 St. Florian

phone: 07224/690 Series

Fax: 07224/690 extension 612 or 614

<http://www.meinhart.at>

© 2009 MEINHART Kabel Österreich GmbH

This catalogue must not be photo mechanically or electronically reproduced, reprinted or photocopied, in whole or in part without our prior written permission.

The company MEINHART Kabel

MEINHART Kabel was founded in 1978 and is an internationally active, independent trading company which specialises in cable and wires.

MEINHART Kabel co-operates with renowned manufacturers and possesses extensive and multifaceted knowledge and experience in a whole range of areas of application. This know-how facilitates comprehensive and objective customer consulting.

The strict quality policies applicable to the products sold by us, as well as superb logistics are decisive for the success of our company. Through our quality management system, which complies with ISO 9002, we offer to our customers, among other things, a consistently good service and transparency in all process areas - from material management through to the distribution.

Due to motivated employees, state-of-the-art machines and a modern vehicle park, an expansive company site, as well as the wide selection of stock, MEINHART Kabel is able to deliver just in time. Modern offices and an enlargement of the storage area have been our latest steps into the future. Additional steps will follow.



Meinhart - company premises in St. Florian / Linz

Release of the Federal Ministry of national defence No. 13088/212 - 1/6/90



1



2



3



4



5



6

- 1 office building
- 2 spooling machines
- 3 fleet of trucks
- 4 pallet warehouse
- 5 drums
- 6 open-air warehouse

Explanatory notes

Prices:

The indicated prices are non-binding gross prices and do not represent a price recommendation for the retailer. They apply up to revocation excluding sales tax as per the "General delivery conditions for cable, sets and isolated wires".

Prices in boldface = standard or stock types

Prices in non-boldface = non standard types

Metal bases:

The list prices are based on the following metal bases:

Copper: EUR 130.00 / 100 kg

Aluminium: EUR 100.00 / 100 kg

Lead: EUR 50.00 / 100 kg

The total sum including metals is calculated with the metal charges as indicated on our homepage.

Alloy surcharge for compensating cables and extension cables: EUR/ m and pair of conductors.

Cut expense surcharge:

A cut expense surcharge by the height of 15 EUR is charged with cut lengths for:

- Cable and wires up to 16mm² with an order amount less than 100 m per item
- Cable and wires up to 25mm² with an order amount less than 25 m per item

Surcharges for small quantities:

A surcharge for small quantities by the height of 10 EUR is settled with orders with an order value less than 250 EUR (for metal surcharges and VAT).

Dimensions and technical data:

Weights, dimensions and properties are only approximate. Errors are excepted in the text and illustrations, and the company reserves the right to make alterations in the technical design of its products. All former catalogues cease to be valid with this edition.

Length marking:

Cables can have a length marking (in meters) on the sheath, which is in conformity with the DIN VDE 0276. The deviation of the cable length, which is expelled by the length marking amounts up to 1%, because this length marking is not appropriate for verification. An incomplete length marking cannot be asserted as fault.

Issue 2009

Table of Contents

Price list & technical data	Description	Austrian type	Page
PVC Insulated Wires	H05V-U	Yse	11
	H07V-U	Ye	12
	H07V-R	Ym	13
	H05V-K	Ysf	14
	H07V-K	Yf	15 / 16
	AWG – Wires		17 / 18
	NYL 5/10 kV	AYZL	19 20
PVC Sheathed Wires	NYM	YM	21 / 22
	(N)YM(ST)		23
		YMT	24
PVC Sheathed Wires	(H)03VH-H	YZwL	25
	(N)YFAZ		26
		LFZ-XY	27
		LSP	28
	H03VVH2-F	YML fl.	29
	H03VV-F	YML	30
	A03VV-F	YML	30 / 31
	H05VV-F	YMM	32 / 33
	A05VV-F	YMM	33
		YMS	34
	Rubber Insulated and Sheathed Cables	H05RR-F	GML
H07RN-F		GMSuö	36 - 38
A07RN-F		GMSuö	38
NSSHöu			39 / 40
A07RN-R		GWuö / DSTL	41
NSGAFöu		GHuöf	42
H01N2-D		GSfföu	43
H01N2-E			44
Solar Cable			45
H05RNH2-F			46
Cables for Cranes and Hoists		NSHTöu(K)	
	NSHTöu / Cordaflex (SMK)		49 / 50
	FLGöu / STN		51
	NGFLGöu		52 / 53
	H07VVH6-F		54 / 55
Building Site Cables		XYMM K35	56
	N07V3V3-F		57
	H05BQ-F		58
	H07BQ-F		59
	07BQ-F		60
PVC Control Cables	YSLY	LSYY	61 - 63
	YSLCY	LSYCVY	64 / 65
	YSLYQY	LSYYQvY	66 / 67
	H05VV5-F		68 / 69
	H05VVC4V5-K		70 / 71
	H05VV5-F UL/CSA (Multinorm)		72 / 73
	H05VVC4V5-K UL/CSA (Multinorm)		74 / 75
	YSLY-EB (intrinsically safe)		76
	YSLCY-EB (intrinsically safe)		77
	SLM		78
	SLCM		79
	2YSLCY		80 / 81
	2YSLCY-K		82 / 83
	YSL11Y		84

Price list & technical data	Description	Austrian type	Page
Cable Chain Cables	S 80		85 / 86
	S 80 C		87 / 88
	S 200		89 / 90
	S 200 C		91 / 92
	S 368 C		93 / 94
	S 369 C TP		95 / 96
	SL 800		97
	SL 801 C		98
	SL 803 C		99
	SL 805		100
	SL 806 C		101
	SL 808 C		102
Heat Resistant Cables and Silicone Cables	H07G-K		103
	SiA		104
	SiF		105
	SiF / GL		106
	SiHF		107 / 108
	SiHFP		109
	SiFCuSi		110
	Ignition Cable 16 kV blue		111
Power Cables 0.,6/1 KV PVC Insulated		E-YY	112-114
	NY Y		115-117
		E-Y2Y	118
	NAYY	E-AYY	119 / 120
		E-AY2Y	121
		E-A2Y	122
	NYCY		123 / 124
		E-YYC	125 / 126
	NYCWY		127 / 128
	Copper Rope		129
Power Cables 6 - 30 KV PVC and VPE Insulated	NYFGY 3,6/6 KV	E-YFGY 3,6/6 KV	130
	N2XSEY 6/10 KV	E-2XHCEY 6/10 KV	131
	N2XSY 10-30 KV	E-2XHCY 10-30 KV	132 / 133
	N2XS2Y 10-30 KV	E-2XHC2Y 10-30 KV	134 / 135
	N2XS(F)2Y 10-30 KV	E-2XHCJ2Y 10-30 KV	136 / 137
	NA2XSY 10-30 KV	E-A2XHCY 10-30 KV	138 / 139
	NA2XS2Y 10-30 KV	E-A2XHC2Y 10-30 KV	140 / 141
	NA2XS(F)2Y 10-30 KV	E-A2XHCJ2Y 10-30 KV	142 / 143
Halogen-Free Cables and Wires with and without Insulation and Circuit Integrity	H07Z-U		144
	H05Z-K		145
	H07Z-K		146
	NHXMH		147 / 148
	HSLH		149 / 150
	HSLCH		151 / 152
	N2XH		153 / 154
	N2XCH		155 / 156
	J-H(ST)H		157 / 158
	JE-H(ST)H BMK (Fire Alarm Cable)		159
	J-H(ST)H EIB		160
	NHXH E 30		161 - 163
	NHXCH E 30		164 / 165
	JE-H(ST)H E 30		166
	JE-H(ST)H E30 BMK (Fire Alarm Cable)		167
	NHXH E 90		168 / 169
	NHXCH E 90		170 / 171
	JE-H(ST)H E 90		172
JE-H(ST)H E 90 BMK (Fire Alarm Cable)		173	

Price list & technical data	Description	Austrian type	Page
Fire Alarm Cables	J-YY BMK	JB-YY	174
	J-Y(ST)Y BMK	JB-Y(ST)Y	175
Telecommunication Cables		F-vYAY	176
		F-YAY	177 / 178
	J-Y(ST)Y		179 / 180
		YYSCH	181
	YR		182
		F-vYDvY	183
		F-2YA2Y	184 / 185
		F-2YC2Y	186 / 187
		F-2YJA2Y	188 / 189
		A-2Y(L)2Y	190
	A-2YF(L)2Y	191 / 192	
Coaxial Cables	RG-Cable		193 - 198
	2YCFGY		199
	2YALGY		200
	2YAFCY		201
	O2YAFCY		202
	DIGITAL 2000		203
Electronic and Computer Cables	LiYY		204 / 205
	LiYCY		206 - 208
	LiYCY paired		209 / 210
	JE-Y(ST)Y		211
	JE-LiYCY		212
		YMLCM	213
	RS-2YCY ... PiMF		214
	IBM TYP 1A		215
	2Y2YCY IBM Twinax		216
	J-Y(St)Y EIB		217
	J-2Y(St)Y III Bd ISDN		218
	Profibus-Wire L2		219
	Interbus		220
	CAN-Bus Fieldbus		221
	LAN 200 flex		222
	LAN 200 U		223
	LAN 200 / 200 duplex		224 / 225
	LAN 200C / 200C duplex		226 / 227
	LAN 350		228 / 229
	LAN 600 / 900 / 1200		230 - 235
A-DQ(ZN)2Y / A-DQ(ZN)B2Y		236	
Compensating and Thermal Cables	PVC- Insulated		237 / 238
	PVC- Insulated with Cu-Screening		239 / 240
	Silicone- Insulated with or without Steel Wire Braiding		241
	Silicone- Insulated with Cu-Screening		242
Table of Contents	General Information		243
General Information and technical appendix			244-271

Further cable-distribution programme
according to national and international standards

Insulated Power Cables

PVC Control Cable combined, highly flexible, cold-resistant

Neoprene Control Cable with Screening

Neoprene and PVC - Flat wire with Screening

Elevator Control cables

Rubber Insulated and Sheathed Cables for

- Lighting
- Reeling
- Cutting machines
- Application in water
- Special applications

Trailing cables for

- Hoists
- Electric power supply on building sites
- Crane systems
- Demolition machines

Insulated Power Cables

Paper lead cable with copper and aluminium core

Plastic paper lead cable

Plastic cable with flat or round wire armouring

Plastic cable with aluminium core and screen of copper wire

Ship cable

Telecommunication Cables and Wires

Telecommunication cable with armouring

Telecommunication cable with lead sheath

Control, measuring and signal technology

Mining signal cable and mining telecommunication cable

PVC Wires, sheaths and hose lines

Rubber Insulated and Sheathed Cables

Cables for Cranes and Hoists

Building Site Cables

PVC Control Cables

Cable Chain Cables, Servo- and Composite Connection Cable

Heat Resistant Cables and Silicone Cables

Power Cables 0.6/1 KV, PVC and VPE Insulated, 6-30 KV, PVC and VPE Insulated, Copper Rope

Halogen-Free Cables and Wires with and without Insulation and Circuit Integrity

Fire Alarm Cables

Telecommunication Cables

Coaxial Cable

Electronic and Computer Cables, Category-Cable LAN 200 / 350 / 600-900-1200 , LWL Cable

Compensating and Extension Cables

General Information and technical appendix

H05V-U (Yse) PVC Insulated Single Core Wire

Application: For protected fixed installations inside appliances and in or on lighting fittings. Further for installations in pipes on and under plaster, however, only for signal circuit and control circuit.



Construction: 1 solid bare copper
2 PVC insulation

Standards: DIN VDE 0281-3
DIN EN 60228 Class 5 (construction)

Technical data:

Nominal voltage U ₀ /U		[V]	300 / 500 Volt
Test voltage		[V] _{AC}	2000
Temperature range	in motion		+5°C till +70°C
Operating temperature	short circuit	°C	160
Short circuit time	max.	[sec]	5
Bending radius	min.	x diameter	4
Flammability	standard		EN 60332-1-2

Nominal cross section	Colours	Price	Copper figure	Cond. construction (appr. value)	Overall diameter	Weight
mm ²		EUR / km	kg/km	mm	appr. mm	appr. kg / km
1	bk/bl/br/gy gr/vi/wt/or gn/ye/rd/pk	127,88	10	1 x 1,15	2,6	14

H07V-U (Ye) PVC Insulated Single Core Wire

Application: For indoor fixed installations in dry locations, in switchboards and distributors, installed in surface mounted or embedded conduits, or on suitably objects.



Construction:
 1 solid bare copper
 2 PVC insulation

Standards:
 DIN VDE 0281-3
 DIN EN 60228 Class 1 (construction)

Technical data:

Nominal voltage U ₀ /U	[V]	450 / 750 Volt
Test voltage	[V] _{AC}	2500
Temperature range	in motion	+5°C till +70°C
Operating temperature	short circuit	160
Short circuit time	max.	5
Flammability	standard	EN 60332-1-2

Nominal cross section	Colours	Price	Copper figure	Cond. construction (appr. value)	Overall diameter	Weight
mm ²		EUR / km	kg/km	mm	appr. mm	appr. kg / km
1,5	bk/bl/br	131,22	15	1 x 1,38	3,2	20
	gy/dbl	137,78	15	1 x 1,38	3,2	20
	gr/vi/wt	144,32	15	1 x 1,38	3,2	20
	or/gn/ye/rd	144,32	15	1 x 1,38	3,2	20
2,5	bk/bl/br	219,29	25	1 x 1,78	3,9	31
	gy	230,25	25	1 x 1,78	3,9	31
	gr/vi/wt/or/gn/rd	241,22	25	1 x 1,78	3,9	31
4	bk/bl	326,53	40	1 x 2,25	4,4	46
	br/gy/vi/gn/ye/rd	359,21	40	1 x 2,25	4,4	46
6	bk/bl/br	470,83	60	1 x 2,76	5,0	65
	gy/vi/rd	517,91	60	1 x 2,76	5,0	65
10	bk/bl	793,57	100	1 x 3,56	6,4	109
	br/gy	872,94	100	1 x 3,56	6,4	109

H07V-R (Ym) PVC Insulated Single Core Wire

Application: For indoor fixed installations in dry locations, in switchboards and distributors, installed in surface mounted or embedded conduits, or on suitably objects.

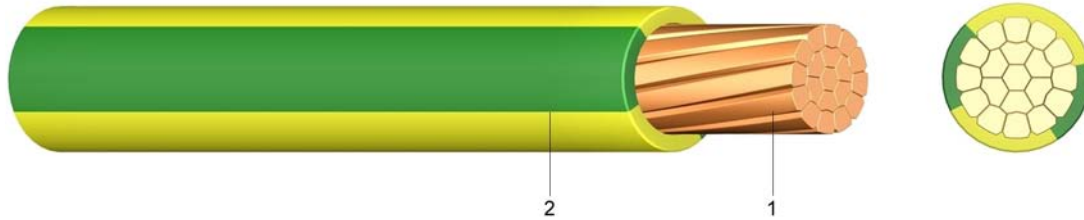

Construction: 1 stranded bare copper, compacted
2 PVC insulation

Standards: DIN VDE 0281-3
DIN EN 60228 Class 2 (construction)

Technical data:

Nominal voltage U ₀ /U	[V]	450 / 750 Volt
Test voltage	[V] _{Ac}	2500
Temperature range	in motion	+5°C till +70°C
Operating temperature	short circuit	160
Short circuit time	max.	[sec]
Bending radius	min.	x diameter
Flammability	standard	EN 60332-1-2

Nominal cross section	Colours	Price	Copper figure	Cond. construction (appr. value)	Overall diameter	Weight
mm ²		EUR / km	kg/km	mm	appr. mm	appr. kg / km
6	bk/bl	643,21	60	7 X 1,05	5,0	66
	gy	707,55	60	7 X 1,05	5,0	66
10	bk/bl/br	909,03	100	7 X 1,35	6,0	110
	gy	999,92	100	7 X 1,35	6,0	110
16	bk/bl	1.379,16	160	7 X 1,70	7,0	170
	br/gy	1.517,07	160	7 X 1,70	7,0	170
25	bk	2.158,69	250	7 X 2,13	9,0	270
	bl/br/gy	2.374,55	250	7 X 2,13	9,0	270
35	bk	2.938,06	350	7 X 2,52	10,0	360
	bl/br/gy	3.231,88	350	7 X 2,52	10,0	360
50	bk	3.932,39	500	19 X 1,83	11,0	530
	bl/gy	4.325,64	500	19 X 1,83	11,0	530
70	bk	5.528,39	700	19 X 2,17	14,0	740
	bl/gy	6.081,22	700	19 X 2,17	14,0	740
95	bk	7.454,31	950	19 X 2,52	15,0	1.000
	gy	8.199,74	950	19 X 2,52	15,0	1.000
120	bk	9.458,81	1.200	37 X 2,03	18,0	1.250
	gy	10.404,68	1.200	37 X 2,03	18,0	1.250
150	bk	11.369,95	1.500	37 X 2,27	19,0	1.580
	gy	12.506,94	1.500	37 X 2,27	19,0	1.580
185	bk	13.958,60	1.850	37 X 2,52	21,0	1.930
	gy	15.354,47	1.850	37 X 2,52	21,0	1.930
240	bk	18.165,10	2.400	61 X 2,24	23,0	2.500
	gy	19.981,59	2.400	61 X 2,24	23,0	2.500
300	bk	24.721,71	3.000	61 X 2,50	29,6	3.130

H05V-K (Ysf) PVC Insulated Single Core Wire

Application: For protected fixed installations inside appliances and in or on lighting fittings.
For installations in pipes on and under plaster, however, only for signal circuit.



Construction: 1 fine stranded bare cooper
2 PVC insulation

Information: two coloured construction on enquiry

Standards: DIN VDE 0281-3
DIN EN 60228 Class 5 (construction)

Technical data:

Nominal voltage U ₀ /U		[V]	300 / 500 Volt
Test voltage		[V] _{AC}	2000
Temperature range	in motion		+5°C till +70°C
Operating temperature	short circuit	°C	160
Short circuit time	max.	[sec]	5
Bending radius	min.	x diameter	4
Flammability	standard		EN 60332-1-2

Nominal cross section	Colours	Price	Copper figure	Cond. construction (appr. value)	Overall diameter (appr. mm)	Weight (appr. kg / km)
mm ²		EUR / km	kg/km	mm	mm	kg / km
0,50	bk/bl/br	120,13	5,0	16 x 0,21	2,2	10
	gy/dbl/gr/lgr/vi/wt	122,45	5,0	16 x 0,21	2,2	10
	or/gn/ye/rd/pk/nat	122,45	5,0	16 x 0,21	2,2	10
	blwt/rdwt/rdye	122,45	5,0	16 x 0,21	2,2	10
	bkye/bkwt	122,45	5,0	16 x 0,21	2,2	10
0,75	bk/bl/br/sbl	140,00	7,5	24 x 0,21	2,4	12
	gy/dbl/lbl/gr	152,61	7,5	24 x 0,21	2,4	12
	vi/wt/or/gn/rd	152,61	7,5	24 x 0,21	2,4	12
	blrd/blwt/wtbr	152,61	7,5	24 x 0,21	2,4	12
	dblwt/rdwt/gnwt	152,61	7,5	24 x 0,21	2,4	12
	gnbk/rdbk	152,61	7,5	24 x 0,21	2,4	12
1	bk/bl/br	161,25	10,0	32 x 0,21	2,6	14
	gy/dbl/lbl/gr/vi	175,59	10,0	32 x 0,21	2,6	14
	wt/or/gn/ye/rd	175,59	10,0	32 x 0,21	2,6	14
	blwt/rdwt/brwt	175,59	10,0	32 x 0,21	2,6	14
	bkwt/yebk/vibk	175,59	10,0	32 x 0,21	2,6	14
	blbk/brbk/viwt	175,59	10,0	32 x 0,21	2,6	14

H07V-K (Yf) PVC Insulated Single Core Wire

Application: For indoor fixed installations in dry locations, in electrical equipment, switchboards and distributors. Should be installed in surface mounted or embedded conduits, for protected fixed installations in or on lighting fittings. Suitable for installations in machines for nominal voltages up to 1.000 V alternating current or up to 750 V to earth direct current. Cannot be used for installations under the wall surface.



Construction: 1 fine-stranded bare copper
2 PVC insulation

Information: two coloured construction on enquiry

Standards: DIN VDE 0281-3
DIN EN 60228 Class 5 (construction)

Technical data:

Nominal voltage U ₀ /U	[V]	450 / 750 Volt
Test voltage	[V] _{ac}	2500
Temperature range	in motion	+5°C till +70°C
Operating temperature	short circuit	160
Short circuit time	max.	[sec]
Bending radius	min.	x diameter
Flammability	standard	EN 60332-1-2

Nominal cross section	Colours	Price	Copper figure	Cond. construction (appr.value)	Overall diameter	Weight
mm ²		EUR / km	kg/km	mm	appr. mm	appr. kg / km
1,5	bk/bl/br	211,83	15	30 x 0,26	3,1	21
	yg/dbl/lbl/gr/vi	237,29	15	30 x 0,26	3,1	21
	wt/or/gn/ye/rd/pk/nat	237,29	15	30 x 0,26	3,1	21
	blye/blbk/blwt/grgn	237,29	15	30 x 0,26	3,1	21
	rdbk/rdgn/rdwt/bkwt	237,29	15	30 x 0,26	3,1	21
2,5	bk/bl/br	333,80	25	50 x 0,26	3,7	32
	yg/dbl/lbl/sbl/gr/lgr	354,93	25	50 x 0,26	3,7	32
	vi/wt/or/gn/ye/rd	354,93	25	50 x 0,26	3,7	32
	pk/blwt/rdwt	354,93	25	50 x 0,26	3,7	32
4	bk/bl/br/yg	510,92	40	56 x 0,31	4,3	47
	dbl/lbl/gr/vi/wt	531,88	40	56 x 0,31	4,3	47
	or/gn/ye/rd/blwt/rdwt	531,88	40	56 x 0,31	4,3	47
6	bk/bl/br	704,52	60	84 x 0,31	4,9	67
	gy/lbl/gr/vi	724,73	60	84 x 0,31	4,9	67
	wt/gn/ye/rd	724,73	60	84 x 0,31	4,9	67
10	bk/bl/br	1.335,02	100	80 x 0,41	6,2	115
	yg/lbl/gr/vi/rd	1.403,91	100	80 x 0,41	6,2	115
16	bk/bl/br	1.969,09	160	128 x 0,41	7,4	175
	yg/lbl/gr/rd	2.010,05	160	128 x 0,41	7,4	175
25	bk	2.255,85	250	200 x 0,41	9,3	280
	bl/br/yg/lbl/rd	2.481,44	250	200 x 0,41	9,3	280

Nominal cross section	Colours	Price	Copper figure	Cond. construction (appr. value)	Overall diameter appr.	Weight appr.
mm²		EUR / km	kg/km	mm	mm	kg / km
35	bk	3.028,51	350	280 x 0,41	10,7	375
	bl/br/yg/lbl/rd	3.331,36	350	280 x 0,41	10,7	375
50	bk	4.588,90	500	400 x 0,41	12,7	550
	bl/yg	5.047,80	500	400 x 0,41	12,7	550
70	bk	6.674,09	700	356 x 0,51	14,8	760
	bl/yg	7.341,50	700	356 x 0,51	14,8	760
95	bk	8.942,44	950	485 x 0,51	16,7	1.020
	yg	9.836,68	950	485 x 0,51	16,7	1.020
120	bk	10.811,86	1.200	614 x 0,51	18,4	1.270
	yg	11.893,05	1.200	614 x 0,51	18,4	1.270
150	bk	13.831,99	1.500	765 x 0,51	20,5	1.600
	yg	15.215,18	1.500	765 x 0,51	20,5	1.600
185	bk	16.971,70	1.850	944 x 0,51	22,8	1.960
240	bk	21.733,73	2.400	1225 x 0,51	25,9	2.550

AWG-Litzen **PVC Insulated Single Core Wire with UL and CSA approbation**

Application: To the internal wiring of devices, switch arrangements and machines as well as for the protected transfer in and on lights.



Construction:
 1 fine-stranded bare copper
 2 PCV insulation

Information:
 AWG 24 = app. 0,205mm² AWG 14 = app. 2,080mm²
 AWG 22 = app. 0,324mm² AWG 12 = app. 3,310mm²
 AWG 20 = app. 0,519mm² AWG 10 = app. 5,261mm²
 AWG 18 = app. 0,823mm² AWG 08 = app. 8,367mm²
 AWG 16 = app. 1,310mm² AWG 06 = app. 13,30mm²
 More cross sections on enquiry.

Standards:
 DIN EN 60228 Class 5 (construction)
 UL / CSA / MTW 1015+1063
 UL 758, UL 1581
 CSA C 22.2 Nr. 127

Technical data:

Nominal voltage U ₀ /U	[V]	600 Volt
Test voltage	[V] _{AC}	4000
Temperature range	in motion fixed	+5°C till +105°C -15°C till +105°C
Operating temperature	short circuit	160
Short circuit time	max. [sec]	5
Flammability	standard	EN 60332-1-2

Nominal cross section	Colours	Price	Copper figure	Cond. construction (appr. value)	Overall diameter	Weight
mm ²		EUR / km	kg/km	mm	appr. mm	appr. kg / km
AWG 24/7	bk/bl/br/vi/wt/gn/ye/rd	540,58	2,2	14 x 0,15	2,2	8
AWG 22	bk/bl/br/yg/dbl/gr vi/wt/or/gn/ye/rd	289,57	5,0	16 x 0,20	2,4	10
AWG 20	bk/bl/br/yg/dbl/gr vi/wt/or/gn/ye/rd	322,47	7,5	24 x 0,20	2,6	12
AWG 18	bk/bl/br/yg/dbl/gr vi/wt/or/gn/ye/rd	418,18	10,0	32 x 0,20	2,8	16
AWG 16	bk/bl/br/yg/dbl/gr vi/wt/or/gn/ye/rd	455,18	15,0	84 x 0,30	3,1	22
AWG 14	bk/bl/br/yg/dbl/gr vi/wt/or/gn/ye/rd	686,48	25,0	50 x 0,25	3,5	31

Nominal cross section	Colours	Price	Copper figure	Cond. construction (appr. value)	Overall diameter appr.	Weight appr.
mm²		EUR / km	kg/km	mm	mm	kg / km
AWG 12	bk/bl/br/yp/dbl/gr vi/wt/or/gn/ye/rd	932,95	40,0	56 x 0,30	4,0	45
AWG 10	bk/bl/br/yp/dbl/gr vi/wt/or/gn/ye/rd	1.357,66	60,0	84 x 0,30	4,6	65
AWG 8	bk/bl/br/yp/dbl/gr vi/wt/or/gn/ye/rd	2.076,04	100,0	80 x 0,40	6,5	110
AWG 6	bk/bl/br/yp/dbl/gr vi/wt/or/gn/ye/rd	4.142,10	160,0	128 x 0,40	8,0	175

AYZL

PVC Ignition Wire 1kV

Application: In automobiles and similar systems.



Construction: 1 fine-stranded tinned copper
2 special PVC insulation

Standards: DIN EN 60228 Class 5 (construction)

Technical data:

Nominal voltage U ₀ /U		[V]	1000 Volt
Test voltage		[V] _{AC}	15000
Temperature range	in motion		+5°C till +70°C
Bending radius	min.	x diameter	12,5
Flammability	standard		EN 60332-1-2

Nominal cross section	Colours	Price	Copper figure	Cond. construction (appr. value)	Overall diameter	Weight
mm ²		EUR / km	kg/km	mm	appr. mm	appr. kg / km
1,5/5	sw	281,24	15	30 x 0,26	5,0	38

NYL 5/10 KV PVC Neon Tube

Application: For the use in the lighting tubes and in high voltage system which agree with EN 50107. In letter cases and relief body from metal and art out of vision, in ventilated canals without condensation water and pipes, in cable and cover strips from metal and plastic, on plaster, in dry, humid and wet rooms, as well as outside.



Construction: 1 fine-stranded tinned copper
2 core insulation of polyvinylchloride (PVC), yellow

Standards: DIN EN 60228 Class 5 (construction)
DIN VDE 0283 Part 1
DIN EN 50143

Technical data:

Nominal voltage U_0/U		[V]	5000 / 10000 Volt
Test voltage		[V] _{AC}	15000
Temperature range	in motion		+5°C till +70°C
Bending radius	min.	x diameter	4
Flammability	standard		EN 60332-1-2

Nominal cross section	Colours	Price	Copper figure	Cond. construction (appr. value)	Overall diameter	Weight
mm ²		EUR / km	kg/km	mm	appr. mm	appr. kg / km
1,5	ge	1.203,86	15	30 x 0,26	7,5	55

(N)YM PVC Sheathed Wire

Application: Only for fixed installations in dry, humid and wet locations. Not suitable for laying directly open-air or in concrete.

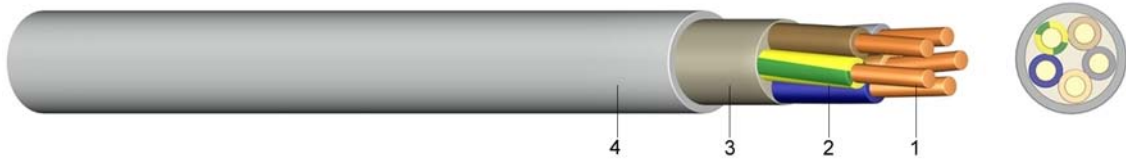

Construction:

- 1 bare copper, solid (RE) or stranded (RM)
- 2 polyvinylchloride (PVC) insulation
- 3 common core covering
- 4 polyvinylchloride (PVC) outer sheath, grey or special colours

Information: Core identification at 7 cores: black with figures or colourd cores (core colours: green/yellow, violet, pink, orange, brown, black, blue). From 10 cores on, all cores are black with figures.

Standards:

NYM : DIN VDE 0250-204
 DIN EN 60228 Class 1 (RE) and class 2 (RM) (construction)
 YM : ÖVE / ÖNORM E 8241
 HD 308 S2 (core identification)

Technical data:

Nominal voltage U ₀ /U		[V]	300 / 500 Volt
Test voltage		[V] _{Ac}	2000
Temperature range	in motion		+5°C till +70°C
	fixed		-40°C till +70°C
Operating temperature	short circuit	°C	160
Short circuit time	max.	[sec]	5
Bending radius	min.	x diameter	4
Flammability	standard		EN 60332-1-2

Number of cores and nominal cross section mm ²	Price EUR / km J	Price EUR / km O	Copper figure kg/km	Overall diameter appr.mm	Calorific potential kwh / m	Weight appr. kg / km
2 x 1,5 RE		833,81	30	8,5	0,42	105
2 x 2,5 RE		1.279,06	50	9,5	0,53	145
3 x 1,5 RE	684,18	890,98	45	8,8	0,44	121
3 x 2,5 RE	1.225,73	1.372,11	75	10,4	0,58	170
3 x 4 RE	2.063,07		120	11,5	0,72	241
3 x 6 RE	2.796,05		180	13,0	0,92	328
4 x 1,5 RE	875,02	1.097,88	60	9,6	0,53	144
4 x 2,5 RE	1.690,76	1.951,00	100	11,2	0,67	206
4 x 4 RE	2.324,04		160	13,2	0,92	305
4 x 6 RE	2.926,66	3.344,76	240	14,8	1,08	400
4 x 10 RE	4.366,92		400	17,8	1,50	622
4 x 10 RM	4.903,33	5.246,56	400	17,8	1,50	622
4 x 16 RM	7.126,62	7.601,72	640	21,8	1,86	924
5 x 1,5 RE	1.042,43		75	10,3	0,58	168
5 x 2,5 RE	1.866,38		125	12,1	0,75	242
5 x 4 RE	2.774,21		200	14,7	1,11	360
5 x 6 RE	4.391,31		300	16,1	1,28	476

Number of cores and nominal cross section mm²	Price EUR / km J	Price EUR / km O	Copper figure kg/km	Overall diameter appr.mm	Calorific potential kwh / m	Weight appr. kg / km
5 x 10 RE	5.912,54		500	19,3	1,83	744
5 x 10 RM	6.576,08		500	19,3	1,83	744
5 x 16 RM	9.345,40		800	24,2	2,31	1.145
7 x 1,5 RE	2.324,66	2.726,24	105	11,3	0,67	212
7 x 1,5 RE color. cores	2.726.24		105	11,3	0,67	212
10 x 1,5 RE	3.950,31		150	14,7	1,05	296
12 x 1,5 RE	4.600,95		180	16,0	1,17	345
7 x 2,5 RE	3.859,84		175	14,5	0,88	320
3 x 1,5 RE red	974,82		45	8,8	0,44	121
3 x 2,5 RE red	1.831,48		75	10,4	0,58	170
3 x 4 RE green	974,82		45	8,8	0,44	121

(N)YM(ST)-J PVC Sheathed Wire with Screen Bio Wire

Application: Suitable where effective limitation of electro-magnetic interference fields is necessary, for installations in dry, humid and wet locations. Not suitable for laying directly open-air or in concrete. Not suitable in areas with explosion hazard.

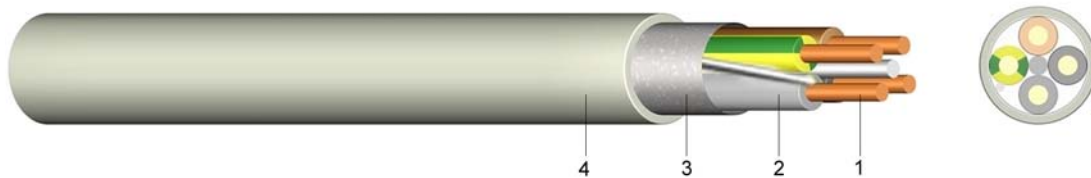

Construction:

- 1 solid bare copper
- 2 polyvinylchloride (PVC) insulation
- 3 screen of plastic coated aluminium tape with tinned drain wire
- 4 polyvinylchloride (PVC) outer sheath, grey

Standards: adapted to DIN VDE 250-204
DIN EN 60228 Class 1 (construction)
HD 308 S2 (core identification)

Technical data:

Nominal voltage U ₀ /U		[V]	300 / 500 Volt
Test voltage		[V] _{Ac}	2000
Temperature range	in motion		+5°C till +70°C
Operating temperature	short circuit	°C	160
Short circuit time	max.	[sec]	5
Flammability	standard		EN 60332-1-2

Number of cores and nominal cross section mm ²	Price EUR / km	Copper figure kg/km	Cond. construction (appr. value) mm	Overall diameter appr. mm	Calorific potential kWh / m	Weight appr. kg / km
3 x 1,5 / 1,5	1.644,72	55	1 x 1,38	10,5	0,44	140
4 x 1,5 / 1,5	1.964,94	68	1 x 1,38	11,5	0,53	188
5 x 1,5 / 1,5	2.191,16	83	1 x 1,38	12,0	0,58	216
7 x 1,5 / 1,5	2.980,56	113	1 x 1,38	13,0	0,67	263
3 x 2,5 / 1,5	2.075,23	83	1 x 1,78	12,0	0,58	214
5 x 2,5 / 1,5	2.776,19	133	1 x 1,78	13,5	0,75	300

YMT

PVC Cable with Steel Carrier

Application:

Usable as a self-supporting circuit on free power mains, in accordance with applicable regulation. They may not be installed directly into the ground.

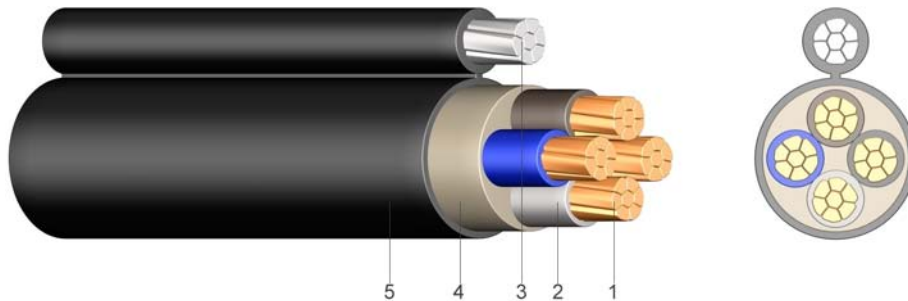

Construction:

- 1 bare copper, solid (RE) or stranded (RM)
- 2 polyvinylchloride (PVC) insulation
- 3 carrier cable steel-reinforced, stranded
- 4 bedding
- 5 polyvinylchloride (PVC) outer sheath, black

Information:

The minimum value for the breaking force of the supporting element amounts to:

- 6.000 N at the 3x2,5 and 5x2,5 mm²
 - 10.500 N at the 4x10 and 4x16 mm²
- Information according to DIN VDE 0250-206

Standards:

according to ÖVE K41
 DIN 57250 part 206
 DIN VDE 250-206
 DIN EN 60228 class 1 and 2 (construction)
 HD 308 S2 (core identification)

Technical data:

Nominal voltage U ₀ /U		[V]	300 / 500 Volt
Test voltage		[V] _{AC}	4000
Temperature range	in motion		+5°C till +70°C
	fixed		-40°C till +70°C
Operating temperature	short circuit	°C	160
Short circuit time	max.	[sec]	5
Bending radius	in motion	x diameter	4
Flammability	standard		EN 60332-1-2

Number of cores and nominal cross section mm ²	Price EUR / km	Copper figure kg/km	Overall measures appr. mm	Weight appr. kg/km
3 x 2,5 RE	2.565,94	75	12,5 x 20,5	190
4 x 10 RM	8.220,95	400	19,0 x 28,0	960
4 x 16 RM	11.805,85	640	22,0 x 32,0	1.320
5 x 2,5 RE	3.749,85	125	14,5 x 23,0	361

(H)03VH-H PVC Twin Wire
(YzwL)

Application: Suitable in dry locations for connections of portable electrical appliances submitted to weak mechanical strength, like radio sets and lighting fittings, but not for heating devices.



Construction:
 1 fine-stranded bare copper, class 6
 2 polyvinylchloride (PVC) insulation, laid up parallel, can be easily divided

Standards: adapted to DIN VDE 081-5
 DIN EN 60228 class 6 (construction)

Technical data:

Nominal voltage U ₀ /U		[V]	300 / 300 Volt
Test voltage		[V] _{AC}	2000
Temperature range	in motion		+5°C till +70°C
Operating temperature	short circuit	°C	150
Short circuit time	max.	[sec]	5
Flammability	standard		EN 60332-1-2

Number of cores and nominal cross section mm ²	Colours	Price EUR / km	Copper figure kg/km	Cond. construction (appr. value) mm	Overall measures appr. mm	Weight appr. kg/km
2 x 0,75	bk/lgr/wt/br	335,61	15	40 x 0,16	2,7 x 5,3	27

(N)YFAZ

PVC Twin Wire

Application:

Suitable in dry locations for connections of portable power consumers submitted to weak mechanical strength like light electrical hand-held equipment and in and on lighting units.

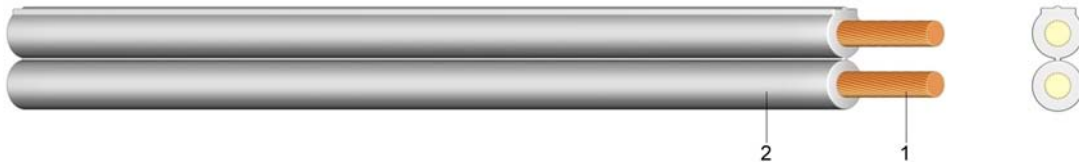

Construction:

- 1 fine-stranded bare copper
- 2 polyvinylchloride (PVC) insulation laid up parallel, can be easily divided, one core insulation is corrugated

Standards:

adapted to DIN VDE 0250
DIN EN 60228 class 5 (construction)

Technical data:

Nominal voltage U_0/U

[V]

300 / 300 Volt

Test voltage

[V]_{ac}

2000

Temperature range

in motion

+5°C till +70°C

Flammability

standard

EN 60332-1-2

Number of cores and nominal cross section mm ²	Colours	Price	Copper figure	Cond. construction (appr. value)	Overall measures	Weight
		EUR / km	kg/km	mm	appr. mm	appr. kg/km
2 x 0,5	wt	267,20	10	16 x 0,20	2,1 x 4,4	16
2 x 0,75	wt	289,56	15	24 x 0,20	2,3 x 5,0	22
2 x 1	wt	495,69	20	30 x 0,20	2,6 x 5,5	28
2 x 1,5	wt	701,84	30	30 x 0,25	2,8 x 6,0	37
2 x 2,5	wt	944,52	50	50 x 0,25	3,6 x 7,5	60
2 x 4	wt	1.666,96	80	56 x 0,30	4,4 x 9,5	101

LFZ-XY

Loudspeaker Wire

Application:

Suitable in dry locations for connections in communication technology, mainly for HIFI applications such as a loudspeaker connecting cable.



Construction:

- 1 very fine-stranded bare copper
- 2 laid up parallel, insulated with very soft PVC, cores are identified by a polarisation stripe

Standards:

according to Factory standard

Technical data:

Nominal voltage U₀/U

[V]

300 / 300 Volt

Test voltage

[V]_{AC}

2000

Temperature range

in motion

-5°C till +70°C

Flammability

standard

EN 60332-1-2

Number of cores and nominal cross section mm ²	Colours	Price	Copper figure	Conductor resistance	Cond. construction (appr. value)	Overall measures	Weight
		EUR / km	kg/km	Ohm/km	mm	appr. mm	appr. kg / km
2 x 1,5	natur	1.020,80	30	13,3	191 x 0,10	3,2 x 6,4	41
2 x 2,5	natur	1.474,47	50	8,0	322 x 0,10	3,7 x 7,4	61
2 x 4	natur	2.404,44	80	5,0	511 x 0,10	4,8 x 9,6	104
2 x 6	natur	3.629,17	120	3,3	765 x 0,10	6,5 x 14,0	160
2 x 10	natur	6.180,83	200	2,0	560 x 0,15	8,0 x 17,0	270

LSP

Loudspeaker Wire

Application:

Suitable in dry locations for connections in communication technology, mainly for HIFI applications such as a loudspeaker connecting cable.



Construction:

1 very fine-stranded bare copper
2 cores laid up parallel, insulated with very soft polyvinylchloride (PVC), coloured cores or cores are identified by a polarisation stripe

Standards:

according to Factory standard

Technical data:

Nominal voltage U₀/U

[V]

300 / 300 Volt

Test voltage

[V]_{AC}

2000

Temperature range

in motion

-5°C till +70°C

Flammability

standard

EN 60332-1-2

Number of cores and nominal cross section mm ²	Colours	Price	Copper figure	Conductor resistance	Cond. construction (appr. value)	Overall measures	Weight
		EUR / km	kg/km	Ohm/km	mm	appr. mm	appr. kg/km
2 x 0,75	rd/bk	297,76	15	26,0	23 x 0,20	2,7 x 5,3	25,8
2 x 1,5	rd/bk	310,61	30	13,3	30 x 0,25	2,8 x 6,2	41,9
2 x 2,5	bk/wt	409,42	50	8,0	70 x 0,20	3,3 x 6,7	65,0

H03VVH2-F PVC Sheathed Wire Flat (YML-fl)

Application: Suitable in dry locations for connections of portable electrical appliances submitted to weak mechanical strength, like radio sets and lighting fittings, but not for heating devices.

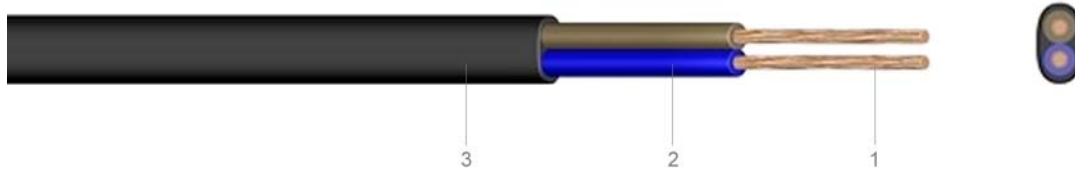

Construction:

- 1 fine-stranded bare copper
- 2 polyvinylchloride (PVC) insulation
- 3 polyvinylchloride (PVC) outer sheath

Standards:

- DIN VDE 0281-5
- DIN EN 60228 class 5 (construction)
- HD 21.5 S3 +A1+A2
- HD 308 S2 (core identification)

Technical data:

Nominal voltage U ₀ /U		[V]	300 / 300 Volt
Test voltage		[V] _{AC}	2000
Temperature range	in motion		-5°C till +70°C
Operating temperature	short circuit	°C	150
Short circuit time	max.	[sec]	5
Bending radius	min.	x diameter	6
Flammability	standard		EN 60332-1-2

Number of cores and nominal cross section mm ²	Colours	Price	Copper figure	Cond. construction (appr. value) mm	Overall measures appr. mm	Weight appr. kg/km
		EUR / km	kg/km			
2 x 0,75	bk	356,39	15	24 x 0,21	4,4/5,6	33
2 x 0,75	gr/wt/br	392,06	15	24 x 0,21	4,4/5,6	33

H03VV-F (YML) PVC Sheathed Wire A03VV-F

Application: Suitable in dry locations for connections of portable electrical appliances submitted to weak mechanical strength, like radio sets and lighting fittings, but not for heating devices.



Construction:

- 1 fine-stranded bare copper
- 2 polyvinylchloride (PVC) insulation
- 3 polyvinylchloride (PVC) outer sheath

Standards:

DIN VDE 0281-5
 HD 21.5 S3 +A1+A2
 DIN EN 60228 class 5 (construction)
 HD 308 S2 (core identification)
 ÖVE / ÖNORM E8241 (HD21)

Technical data:

Nominal voltage U _o /U	[V]	300 / 300 Volt
Test voltage	[V] _{Ac}	2000
Temperature range	in motion	-5°C till +70°C
Operating temperature	short circuit	150
Short circuit time	max.	[sec] 5
Bending radius	min.	x diameter 6
Flammability	standard	EN 60332-1-2

Number of cores and nominal cross section mm ²	Colours	Price EUR / km	Copper figure kg/km	Cond. construction (appr. value) mm	Overall diameter appr. mm	Weight appr. kg / km
2 X 0,5	lgr/wt	386,86	10,0	16 x 0,21	5,9	38
2 X 0,75	bk/lgr/wt	438,75	15,0	24 x 0,21	6,3	48
3 G 0,5	lgr	475,12	15,0	16 x 0,21	6,3	44
	br/bk/wt	522,63	15,0	16 x 0,21	6,3	44
3 G 0,75	lgr/wt	545,76	22,5	24 x 0,21	6,7	57
	bk/br/gold	600,35	22,5	24 x 0,21	6,7	57
4 G 0,5	lgr	716,49	20,0	16 x 0,21	6,9	46
4 G 0,75	lgr	661,72	30,0	24 x 0,21	7,3	65
	bk/wt/br	727,88	30,0	24 x 0,21	7,3	65

A03VV-F

5 G 0,5	lgr	965,41	25,0	16 x 0,21	7,2	72
5 G 0,75	lgr	891,61	37,5	24 x 0,21	7,7	82
	wt/bk	980,77	37,5	24 x 0,21	7,7	82

Number of cores and nominal cross section mm²	Colours	Price EUR / km	Copper figure kg/km	Cond. construction (appr. value) mm	Overall diameter appr. mm	Weight appr. kg / km
A03VV-F						
2 X 1	lgr	530,42	20,0	30 x 0,21	5,8	55
	br/wt	583,47	20,0	30 x 0,21	5,8	55
3 G 1	lgr/wt	766,71	30,0	30 x 0,21	6,2	60
	br/bk	843,38	30,0	30 x 0,21	6,2	60
4 G 1	lgr	891,19	40,0	30 x 0,21	6,8	72
	wt	980,30	40,0	30 x 0,21	6,8	72

H05VV-F(YMM) PVC Sheathed Wire A05VV-F

Application: Suitable in dry and humid locations for connections of electrical appliances submitted to medium level mechanical strength, like washing machines, refrigerators, etc. Suitable for heating appliances provided that there is no risk of contact with hot parts.



Construction:

- 1 fine-stranded bare copper
- 2 polyvinylchloride (PVC) insulation
- 3 polyvinylchloride (PVC) outer sheath

Standards:

- DIN VDE 0281-5
- HD 21.5 S3+A1+A2
- DIN EN 60228 class 5 (construction)
- HD 308 S2 (core identification)
- ÖVE / ÖNORM E 8241 (HD21)

Technical data:

Nominal voltage U ₀ /U		[V]	300 / 500 Volt
Test voltage		[V] _{Ac}	2000
Temperature range	in motion		-5°C till +70°C
Operating temperature	short circuit	°C	150
Short circuit time	max.	[sec]	5
Bending radius	min.	x diameter	5
Flammability	standard		EN 60332-1-2

Number of cores and nominal cross section mm ²	Colours	Price	Copper figure	Cond. construction (appr. value) mm	Overall diameter appr. mm	Weight appr. kg / km
		EUR / km	kg/km			
2 X 1	lgr	606,54	20,0	30 x 0,21	7,5	67
	bk/wt	667,04	20,0	30 x 0,21	7,5	67
2 X 1,5	lgr	733,68	30,0	30 x 0,26	8,6	89
	bk/wt	814,98	30,0	30 x 0,26	8,6	89
2 X 2,5	lgr	1.226,73	50,0	50 x 0,26	10,6	134
	bk	1.362,88	50,0	50 x 0,26	10,6	134
3 G 0,75	lgr	655,97	22,5	24 x 0,21	7,6	64
	wt	1.058,84	22,5	24 x 0,21	7,6	64
3 G 1	lgr	716,91	30,0	30 x 0,21	8,0	80
	wt/bk/br	788,61	30,0	30 x 0,21	8,0	80
3 G 1,5	lgr	859,61	45,0	30 x 0,26	9,4	120
	bk/wt/br/or	946,18	45,0	30 x 0,26	9,4	120
3 G 2,5	lgr	1.472,29	75,0	50 x 0,26	11,4	175
	bl/ws	1.619,29	75,0	50 x 0,26	11,4	175
4 G 1	lgr	1.004,66	40,0	30 x 0,21	9,0	94
	bk/wt	1.104,84	40,0	30 x 0,21	9,0	94

Number of cores and nominal cross section mm ²	Colours	Price	Copper figure	Cond. construction (appr. value)	Overall diameter	Weight
		EUR / km	kg/km	mm	appr. mm	appr. kg / km
4 G 1,5	lgr	1.086,61	60,0	30 x 0,26	10,5	130
	bk/wt	1.206,28	60,0	30 x 0,26	10,5	130
4 G 2,5	lgr	1.872,79	100,0	50 x 0,26	12,5	200
	bk/wt	2.059,21	100,0	50 x 0,26	12,5	200
4 G 4	lgr	2.889,18	160,0	56 x 0,31	14,3	280
5 G 0,75	lgr	1.172,31	37,5	24 x 0,21	9,3	100
	bk/wt	1.302,56	37,5	24 x 0,21	9,3	100
5 G 1	lgr	1.171,92	50,0	30 x 0,21	9,8	120
	wt/bk	1.288,96	50,0	30 x 0,21	9,8	120
5 G 1,5	lgr	1.319,45	75,0	30 x 0,26	11,6	170
	bk/wt/or	1.450,80	75,0	30 x 0,26	11,6	170
5 G 2,5	lgr	2.247,60	125,0	50 x 0,26	13,9	250
	bk/wt/or	2.471,39	125,0	50 x 0,26	13,9	250
5 G 4	lgr	4.007,33	200,0	56 x 0,31	16,1	350
	wt	4.408,06	200,0	56 x 0,31	16,1	350
A05VV-F						
5 G 6	lgr	6.136,18	300,0	84 x 0,31	16,5	480
	wt	6.749,78	300,0	84 x 0,31	16,5	480
7 G 1	lgr	1.961,96	70,0	30 x 0,21	9,0	150
7 G 1,5	lgr	2.260,26	105,0	30 x 0,26	10,4	196
	bk	2.486,29	105,0	30 x 0,26	10,4	196
7 G 2,5	lgr	3.385,22	175,0	50 x 0,26	13,1	315
10 G 1,5	lgr	3.235,54	150,0	30 x 0,26	14,0	305

YMS

PVC Sheathed Wire for Medium-Level Mechanical Stress

Application:

With middle mechanical demands in dry, humid and wet locations, as well as for the installation outside, however not in earth.



Construction:

- 1 fine-stranded bare copper
- 2 polyvinylchloride (PVC) insulation
- 3 with or without rubber inner sheath
- 4 polyvinylchloride (PVC) outer sheath

Standards:

DIN EN 60228 class 5 (construction)
HS 308 S2 (core identification)

Technical data:

Nominal voltage U ₀ /U		[V]	600 / 1000 Volt
Test voltage		[V] _{Ac}	2500
Temperature range	in motion		-5°C till +70°C
Bending radius	min.	x diameter	8
Flammability	standard		EN 60332-1-2

Number of cores and nominal cross section mm ²	Colours	Price	Copper figure	Cond. construction (appr. value)	Overall diameter appr.	Weight
		EUR / km	kg/km	mm	mm	appr. kg / km
3 x 1,5	bk	1.553,18	45	30 x 0,26	10,8	150
4 x 1,5	bk	1.815,24	60	30 x 0,26	11,6	180
5 x 1,5	bk	2.326,56	75	30 x 0,26	12,5	210
3 x 2,5	bk	1.981,10	75	50 x 0,26	12,0	210
	gr	2.179,21	75	50 x 0,26	12,0	210
4 x 2,5	bk	2.444,49	100	50 x 0,26	13,0	250
	gr	2.688,93	100	50 x 0,26	13,0	250
5 x 2,5	bk	3.315,66	125	50 x 0,26	14,0	300
4 x 4	bk	3.672,88	160	56 x 0,31	15,0	350
	gr	4.040,16	160	56 x 0,31	15,0	350
5 x 4	bk	4.776,99	200	56 x 0,31	16,3	430
	gr	5.254,68	200	56 x 0,31	16,3	430
4 x 6	bk	5.205,48	240	84 x 0,31	16,5	470
5 x 6	bk	6.237,35	300	84 x 0,31	18,5	580
	gr	6.861,09	300	84 x 0,31	18,5	580
4 x 10	bk	7.808,03	400	80 x 0,41	20,0	750
5 x 10	bk	10.916,06	500	80 x 0,41	22,0	900
	gr	12.007,67	500	80 x 0,41	22,0	900
4 x 16	bk	11.419,13	640	128 x 0,41	23,4	1.150
5 x 16	bk	15.601,18	800	128 x 0,41	25,4	1.340

H05RR-F (GML)

Rubber Sheathed Cable for Weak Mechanical Stress

Application:

For general use in dry locations for connections of electrical apparatus submitted to weak mechanical strength, like vacuum cleaner, kitchen appliance, etc. unsuitable for industrial and agricultural use.



Construction:

- 1 fine-stranded bare copper
- 2 core insulation of rubber
- 3 outer sheath of ordinary ethylene propylene rubber, black

Standards:

DIN VDE 0282-4
DIN EN 60228 class 5 (construction)
HD 308 S2 (core identification)
HD 22.4 S4:2004

Technical data:

Nominal voltage U ₀ /U		[V]	300 / 500 Volt
Test voltage		[V] _{Ac}	2000
Temperature range	in motion		-25°C till +60°C
Operating temperature	short circuit	°C	200
Short circuit time	max.	[sec]	5
Bending radius	one time / fixed	x diameter	4
Bending radius	in motion	x diameter	8
Flammability	standard		EN 60332-1-2

Number of cores and nominal cross section	Price	Copper figure	Cond. construction (appr. value)	Overall diameter	Weight
mm ²	EUR / km	kg/km	mm	appr. mm	appr. kg / km
2 X 0,75	853,14	15,0	24 x 0,21	6,2	56
3 G 0,75	1.068,36	22,5	24 x 0,21	6,7	72
4 G 0,75	1.505,02	30,0	24 x 0,21	7,3	86
5 G 0,75	1.851,99	37,5	24 x 0,21	8,2	109
2 X 1	1.054,95	20,0	32 x 0,21	6,8	68
3 G 1	1.295,82	30,0	32 x 0,21	7,2	82
4 G 1	1.779,54	40,0	32 x 0,21	7,8	98
2 X 1,5	1.210,90	30,0	30 x 0,26	8,2	101
3 G 1,5	1.563,54	45,0	30 x 0,26	8,8	120
4 G 1,5	2.033,77	60,0	30 x 0,26	9,8	155
5 G 1,5	2.510,62	75,0	30 x 0,26	10,7	185
2 X 2,5	2.055,02	50,0	50 x 0,26	9,7	145
3 G 2,5	2.333,45	75,0	50 x 0,26	10,2	180
4 G 2,5	2.943,86	100,0	50 x 0,26	11,2	225
5 G 2,5	3.636,73	125,0	50 x 0,26	12,7	282

H07RN-F (GMS)

Rubber Sheathed Cable for Medium-Level Mechanical Stress

Application:

For general use in dry, humid and wet locations, for outdoor use, for agricultural applications or in locations subject to explosion hazards. Also suitable for connections of industrial and workshop electrical equipment submitted to medium-level mechanical stress. It can be used for fixed installations in temporary buildings as well as for connections of mobile machines and hoists.

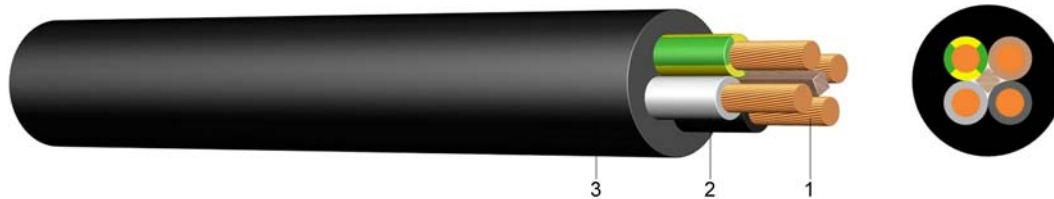

Construction:

- 1 fine-stranded bare copper
- 2 EPR rubber insulation
- 3 outer sheath of polychloroprene compound
(EM2), black, abrasion and oil resistant, flame retardant,

special colours on enquiry

Standards:

- DIN VDE 0282-4
- DIN EN 60228 class 5 (construction)
- HD 308 S2 (core identification)
- HD 22.4 S4:2004

Technical data:

Nominal voltage U ₀ /U		[V]	450 / 750 Volt
Test voltage		[V] _{AC}	2500
Temperature range	in motion		-25°C till +60°C
Operating temperature	short circuit	°C	200
Short circuit time	max.	[sec]	5
Bending radius	one time / fixed	x diameter	4
Bending radius	in motion	x diameter	8
Oil-resistant	standard		EN 60811-2-1
Flammability	standard		EN 60332-1-2

Number of cores and nominal cross section mm ²	Price	Copper figure kg/km	Cond. construction (appr. value) mm	Overall diameter appr. mm	Overall diameter max. value appr. mm	Weight appr. kg / km
	EUR / km					
1 X 1,5	880,03	15	30 x 0,26	5,7	7,1	50
1 X 2,5	1.221,92	25	50 x 0,26	6,3	7,9	66
1 X 4	1.516,96	40	56 x 0,31	7,2	9,0	94
1 X 6	1.865,46	60	84 x 0,31	7,9	9,8	109
1 X 10	3.071,02	100	80 x 0,41	9,5	11,9	182
1 X 16	4.196,37	160	128 x 0,41	10,8	13,4	256
1 X 25	6.038,80	250	200 x 0,41	12,7	15,8	369
1 X 35	8.071,14	350	280 x 0,41	14,3	17,9	482
1 X 50	11.002,11	500	400 x 0,41	16,5	20,6	662
1 X 70	15.374,40	700	356 x 0,51	18,6	23,3	895
1 X 95	19.836,74	950	485 x 0,51	20,8	26,0	1.160

Number of cores and nominal cross section mm²	Price EUR / km	Copper figure kg/km	Cond. construction (appr. value) mm	Overall diameter appr. mm	Overall diameter max. value appr. mm	Weight appr. kg / km
1 X 120	23.634,32	1.200	614 x 0,51	22,8	28,6	1.430
1 X 150	29.587,88	1.500	765 x 0,51	25,2	31,4	1.740
1 X 185	36.958,70	1.850	944 x 0,51	27,6	34,4	2.160
1 X 240	47.898,67	2.400	1225 x 0,51	30,6	38,3	2.730
1 X 300	60.027,79	3.000	1530 x 0,50	33,5	41,9	3.480
2 X 1	1.621,54	20	32 x 0,20	7,7	10,0	99
2 X 1,5	2.028,71	30	30 x 0,26	8,5	11,0	111
2 X 2,5	2.893,40	50	50 x 0,26	10,2	13,1	161
2 X 4	4.174,32	80	56 x 0,31	11,8	15,1	238
2 X 6	5.355,80	120	84 x 0,31	13,1	16,8	279
3 G 1	1.837,12	30	32 x 0,21	8,3	10,7	117
3 G 1,5	2.184,58	45	30 x 0,26	9,2	11,9	134
3 G 2,5	3.145,95	75	50 x 0,26	10,9	14,0	195
3 G 4	4.382,26	120	56 x 0,31	12,7	16,2	290
3 G 6	5.793,48	180	84 x 0,31	14,1	18,0	346
3 G 10	10.009,24	300	80 x 0,41	19,1	24,2	663
3 G 35	29.512,26	1.050	280 x 0,41	29,3	37,1	1.760
3 G 50	37.718,81	1.500	400 x 0,41	34,1	42,9	2.390
4 G 1,5	2.731,09	60	30 x 0,26	10,2	13,1	165
4 G 2,5	3.862,23	100	50 x 0,26	12,5	15,5	245
4 G 4	5.505,51	160	56 x 0,31	14,0	18,0	357
4 G 6	7.472,87	240	84 x 0,31	15,7	20,0	443
4 G 10	10.714,60	400	80 x 0,41	20,8	26,5	818
4 G 16	15.449,44	640	128 x 0,41	23,8	30,1	1.150
4 G 25	23.328,54	1.000	200 x 0,41	28,9	36,6	1.700
4 G 35	31.362,03	1.400	280 x 0,41	32,5	41,1	2.180
4 G 50	42.446,51	2.000	400 x 0,41	37,7	47,5	3.030
4 G 70	60.056,35	2.800	356 x 0,51	42,7	54,0	3.990
4 G 95	79.650,00	3.800	485 x 0,51	48,4	61,0	5.360
4 G 120	101.819,40	4.800	614 x 0,51	53,0	66,0	6.500
4 G 150	139.786,61	6.000	765 x 0,51	58,0	73,0	7.990
4 G 185	171.570,54	7.400	944 x 0,50	64,0	80,0	9.910
5 G 1,5	3.433,18	75	30 x 0,26	11,2	14,4	238
5 G 2,5	5.020,96	125	50 x 0,26	13,3	17,0	297
5 G 4	7.134,65	200	56 x 0,31	15,6	19,9	453
5 G 6	9.057,04	300	84 x 0,31	17,5	22,2	557
5 G 10	15.664,20	500	80 x 0,41	22,9	29,1	1.001
5 G 16	20.393,48	800	128 x 0,41	26,4	33,3	1.430
5 G 25	35.274,98	1.250	200 x 0,41	32,0	40,4	2.096
5 G 35	46.233,11	1.750	280 x 0,41	44,0	50,0	3.008
5 G 50	68.670,75	2.500	400 x 0,41	51,0	58,0	4.390
5 G 70	97.160,26	3.500	356 x 0,51	60,0	67,0	5.296
5 G 95	128.859,24	4.750	485 x 0,51	64,0	71,0	6.250
7 G 1,5	7.024,84	105	30 x 0,26	14,7	17,0	342
12 G 1,5	11.587,08	180	30 x 0,26	18,6	22,2	510
19 G 1,5	18.312,89	285	30 x 0,26	23,0	29,0	630
24 G 1,5	22.774,97	360	30 x 0,26	24,3	30,7	1.000
27 G 1,5	24.846,92	405	30 x 0,26	23,6	32,0	1.077
7 G 2,5	9.209,82	175	50 x 0,26	19,0	19,0	485
12 G 2,5	17.269,56	300	50 x 0,26	24,0	24,0	799
19 G 2,5	24.482,10	475	50 x 0,26	28,0	28,0	1.100
24 G 2,5	34.985,84	600	50 x 0,26	32,5	32,5	1.250
7 G 4	16.932,82	280	56 x 0,31	22,5	21,5	703

Number of cores and nominal cross section mm²	Price EUR / km	Copper figure kg/km	Cond. construction (appr. value) mm	Overall diameter appr. mm	Overall diameter max. value appr. mm	Weight appr. kg / km
A07RN-F						
3 X 1,5	2.184,58	45	30 x 0,26	9,2	11,9	134
3 X 2,5	3.145,95	75	50 x 0,26	10,9	14,0	195
3 X 4	4.382,26	120	56 x 0,31	12,7	16,2	290
3 X 6	5.793,48	180	84 x 0,31	14,1	18,0	346
3 X 10	10.009,24	300	80 x 0,41	19,1	24,2	663
3 X 25	21.959,17	750	200 x 0,41	26,5	34,0	1.585
3 X 35	29.512,26	1.050	280 x 0,41	29,3	37,1	1.760
3 X 50	37.718,81	1.500	400 x 0,41	34,1	42,9	2.390
4 X 1,5	2.731,09	60	30 x 0,26	10,2	13,1	165
4 X 2,5	3.862,23	100	50 x 0,26	12,5	15,5	245
4 X 4	5.505,51	160	56 x 0,31	14,0	18,0	357
4 X 6	7.472,87	240	84 x 0,31	15,7	20,0	443
4 X 10	14.778,30	400	80 x 0,41	20,8	26,5	818
4 X 16	19.574,30	640	128 x 0,41	23,8	30,1	1.150
4 X 25	29.713,63	1.000	200 x 0,41	28,9	36,6	1.700
4 X 35	37.895,06	1.400	280 x 0,41	32,5	41,1	2.180
4 X 50	50.635,07	2.000	400 x 0,41	37,7	47,5	3.030
4 X 70	74.358,32	2.800	356 x 0,51	42,7	54,0	3.990
4 X 95	93.728,25	3.800	485 x 0,51	48,4	61,0	5.360

NSSHöu

Rubber Sheathed Cable for High Mechanical Stress

Application:

These cables are suitable for extreme mechanical stress in dry and humid locations and outdoor use for connections of heavy equipment. For mines and industrial use.

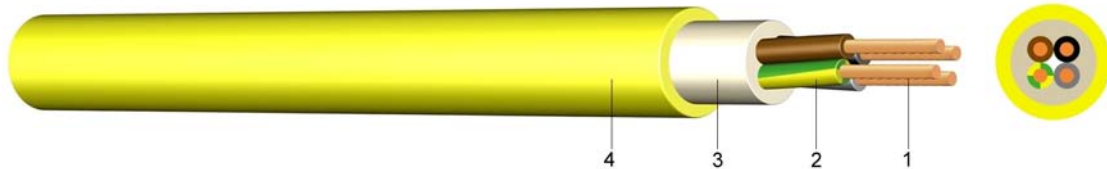

Construction:

- 1 fine-stranded tinned copper
- 2 EPR rubber insulation
(ethylen-propylen polymer)
- 3 rubber inner sheath
- 4 outer sheath of polychloroprene (CR), yellow, abrasion
and oil resistant, flame retardant

Standards:

DIN VDE 0250-812
DIN EN 60228 class 5 (construction)
HD 308 S2 (core identification)

Technical data:

Nominal voltage U ₀ /U		[V]	600 / 1000 Volt
Test voltage		[V] _{Ac}	4000
Temperature range	in motion		-25°C till +80°C
Operating temperature	short circuit	°C	250
Short circuit time	max.	[sec]	5
Bending radius	one time / fixed	x diameter	4
Bending radius	in motion	x diameter	10
Oil-resistant	standard		EN 60811-2-1
Flammability	standard		EN 60332-1-2

Number of cores and nominal cross section mm ²	Price EUR / km J	Price EUR / km O	Copper figure kg/km	Cond. construction (app.value)mm	Overall diameter appr.mm	Weight appr. kg / km
1 x 25		9.038,10	250	200 x 0,41	12,9	350
1 x 35		11.240,57	350	280 x 0,41	13,6	446
1 x 50		14.747,69	500	400 x 0,41	16,0	618
1 x 70		19.052,83	700	356 x 0,51	18,2	838
1 x 95		24.299,66	950	485 x 0,51	20,7	1.082
1 x 120		29.931,86	1.200	614 x 0,51	22,4	1.350
1 x 150		38.445,28	1.500	765 x 0,51	24,6	1.660
1 x 185		45.387,47	1.850	944 x 0,51	28,3	2.067
1 x 240		61.715,14	2.400	1225 x 0,51	30,2	2.621
3 x 1,5	4.631,70		45	30 x 0,26	11,5	184
3 x 2,5	5.780,27		75	50 x 0,26	12,9	245
3 x 70/35	72.814,93		2.450	356 x 0,51	42,2	3.775
3 x 95/50	95.732,46		3.350	485 x 0,51	50,2	5.116
3 x 120/70	119.845,04		4.300	614 x 0,50	55,0	6.388
4 x 1,5	5.264,32		60	30 x 0,26	12,2	213
4 x 2,5	7.202,46		100	50 x 0,26	15,1	328

Number of cores and nominal cross section mm ²	Price EUR / km J	Price EUR / km O	Copper figure kg/km	Cond. construction (appr. value) mm	Overall diameter appr. mm	Weight appr. kg / km
4 x 4	9.645,07		160	56 x 0,31	16,7	423
4 x 6	12.382,75		240	84 x 0,31	18,1	530
4 x 10	17.656,48		400	80 x 0,41	22,3	832
4 x 16	24.369,81		640	128 x 0,41	26,3	1.198
4 x 25	35.758,48		1.000	200 x 0,41	31,5	1.771
4 x 35	47.872,87		1.400	280 x 0,41	33,2	2.196
4 x 50	65.028,06		2.000	400 x 0,41	40,4	3.160
4 x 70	88.448,00		2.800	356 x 0,51	44,8	4.115
4 x 95	102.117,84		3.800	485 x 0,51	52,6	5.516
4 x 120	121.261,28		4.800	614 x 0,51	57,0	6.815
5 x 1,5	6.438,29		75	30 x 0,26	13,1	249
5 x 2,5	8.452,04		125	50x 0,26	16,1	384
5 x 4	12.234,55		200	56 x 0,31	17,9	501
5 x 6	16.735,07		300	84 x 0,31	20,3	672
5 x 10	24.519,69		500	80 x 0,41	24,2	1.001
5 x 16	32.865,37		800	128 x 0,41	28,4	1.445
5 x 25	48.409,59		1.250	200 x 0,41	34,1	2.140
5 x 35	62.932,47		1.750	280 x 0,41	37,4	2.791
7 x 1,5	10.914,11		105	30 x 0,26	16,1	370
7 x 2,5	11.342,89		175	50 x 0,26	18,3	504
10 x 1,5	14.737,35		150	30 x 0,26	19,0	490
12 x 2,5	18.097,69		300	50 x 0,26	22,3	733
18 x 2,5	26.692,91		450	50 x 0,26	26,4	1.055

A07RN-R
(GWuö/DSTL)

Rubber Insulated Single Core Cable
Roof pylon Cable

Application:

In dry and wet locations as well as outdoors for fixed installations. Suitable for span widths up to 20 m as a house lead-in cable, also for appliances within easy reach.

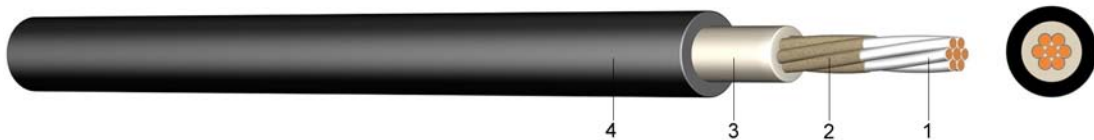

Construction:

- 1 stranded (RM) tinned copper
- 2 separator tape
- 3 rubber insulation (EPR)
- 4 outer sheath of polychloroprene (CR), black

Standards:

adapted to DIN VDE 0282-4
DIN EN 60228 class 2 (construction)

Technical data:

Nominal voltage U₀/U
Temperature range
Flammability

in motion
standard

[V]

1000 Volt
-25°C till +80°C
EN 60332-1-2

Nominal cross section	Colours	Price	Copper figure	Cond. construction (appr. value)	Overall diameter (appr.)	Weight
mm ²		EUR / km	kg/km	mm	mm	appr. kg / km
10	bk	1.959,53	100	7 x 1,35	10,2	183
16	bk	2.849,92	160	7 x 1,70	11,4	260
	bl	3.134,83	160	7 x 1,70	11,4	260
25	bk	4.101,83	250	7 x 2,13	13,3	374
35	bk	5.720,81	350	7 x 2,52	14,3	491
50	bk	8.263,58	500	19 x 1,83	16,5	610
70	bk	11.313,37	700	19 x 2,17	18,5	860

NSGAFöu (GHöuf)

Special Rubber Single Core Cable 1,8 / 3 kV

Application:

For track bound vehicles and trackless trolley buses as well as for installations in dry locations, in switchboards and distributors up to 1.000 V as a short circuit and earth fault proof cable at the nominal voltage of U_0 / U 1.8 / 3 kV.

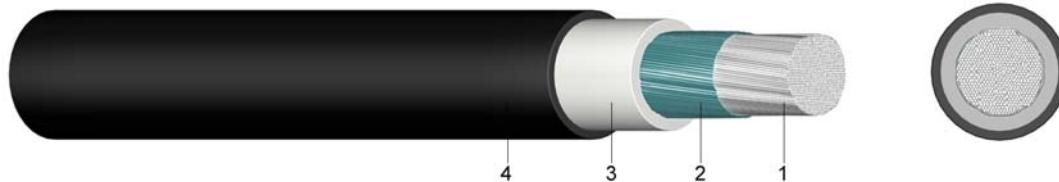

Construction:

- 1 fine-stranded tinned copper
- 2 wrapped with Alu-PT-Film
- 3 EPR rubber insulation
- 4 outer sheath of polychloroprene, black, abrasion an oil resistant, flame retardant

Information:

NSGAFöu 3,6/6KV : Prices and delivery times on inquiry.

Standards:

DIN VDE 0250 part 602
DIN EN 60228 class 5 (construction)

Technical data:

Nominal voltage U_0/U		[V]	1800 / 3000 Volt
Test voltage		[V] _{Ac}	6000
Temperature range	in motion		-25°C till +80°C
Operating temperature	short circuit	°C	200
Short circuit time	max.	[sec]	5
Bending radius	one time / fixed	x diameter	6
Bending radius	in motion	x diameter	10
Oil-resistant	standard		EN 60811-2-1
Flammability	standard		EN 60332-1-2

Nominal cross section	Price	Copper figure	Cond. construction (appr. value)	Overall diameter	Current carrying capacity	Weight
mm ²	EUR / km	kg/km	mm	appr. mm	air A	appr. kg / km
1,5	1.281,08	15	30 x 0,26	6,5	30	60
2,5	1.529,56	25	50 x 0,26	7,0	41	70
4	1.969,12	40	56 x 0,31	7,5	55	90
6	2.307,80	60	84 x 0,31	8,5	70	120
10	3.593,55	100	80 x 0,41	10,0	98	180
16	4.925,86	160	126 x 0,41	11,0	132	250
25	6.832,97	250	196 x 0,41	13,0	176	390
35	8.803,87	350	276 x 0,41	14,0	218	470
50	11.773,87	500	396 x 0,41	15,5	276	625
70	15.286,78	700	360 x 0,51	17,0	347	880
95	19.476,87	950	475 x 0,51	19,5	416	1.190
120	23.495,31	1.200	608 x 0,51	21,5	488	1.430
150	28.239,47	1.500	756 x 0,51	23,0	566	1.750
185	34.039,73	1.850	925 x 0,51	25,0	644	2.160
240	43.151,98	2.400	1221 x 0,51	28,0	775	2.534
300	52.910,99	3.000	1530 x 0,51	32,5	898	3.178

H01N2-D

Welding Cable

Application:

For use on handheld electrodes keepers till 100 V with **normal flexibility**.

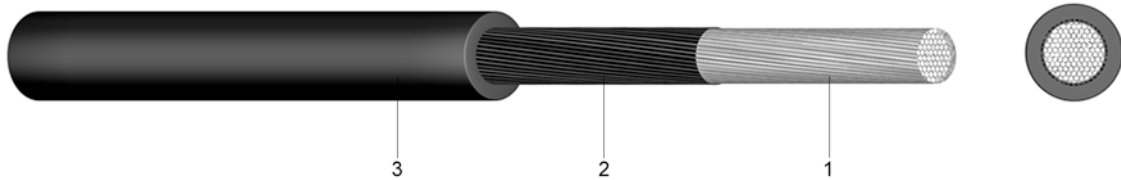

Construction:

- 1 fine-stranded tinned or bare copper
- 2 separator tape
- 3 outer sheath of polychloroprene (EM5), black

Standards:

DIN VDE 0282-6
DIN EN 60228 class 5 (construction)
HD 22.6 S2:1995+A1:1999+A2:2004

Technical data:

Nominal voltage U ₀ /U		[V]	100 / 100 Volt
Test voltage		[V] _{AC}	1000
Temperature range	in motion		-20°C till +80°C
Operating temperature	short circuit	°C	250
Short circuit time	max.	[sec]	5
Bending radius	min.	x diameter	5
Flammability	standard		EN 60332-1-2

Number of cores and nominal cross section mm ²	Price	Copper figure	Wire diameter	Insulation thickness	Overall diameter	Weight
	EUR / km	kg/km	mm	mm	appr. mm	appr. kg / km
1 x 16	4.716,35	160	0,21	2,0	9,5	210
1 x 25	6.318,07	250	0,21	2,0	11,0	300
1 x 35	7.999,12	350	0,21	2,0	12,0	400
1 x 50	10.389,94	500	0,21	2,0	14,0	560
1 x 70	13.172,75	700	0,21	2,4	16,5	780
1 x 95	17.179,55	950	0,21	2,6	18,5	1.010
1 x 120	20.592,79	1.200	0,51	2,8	20,0	1.250

H01N2-E

Welding Cable

Application:

For use on handheld electrodes keepers till 100 V with **high flexibility**.

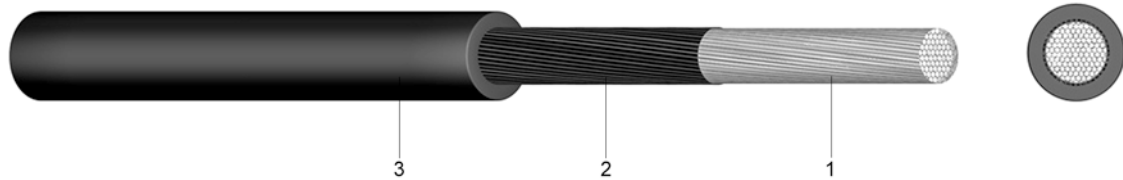

Construction:

- 1 fine-stranded tinned or bare copper
- 2 separator tape
- 3 outer sheath of polychloroprene (EM5), black

Standards:

DIN VDE 282-6
 DIN EN 60228 class 6 (construction)
 HD 22.6 S2:1995+A1:1999+A2:2005

Technical data:

Nominal voltage U ₀ /U		[V]	100 / 100 Volt
Test voltage		[V] _{AC}	1000
Temperature range	in motion		-20°C till +80°C
Operating temperature	short circuit	°C	250
Short circuit time	max.	[sec]	5
Bending radius	min.	x diameter	5
Flammability	standard		EN 60332-1-2

Number of cores and nominal cross section mm ²	Price	Copper figure	Wire diameter	Insulation thickness	Overall diameter	Weight
	EUR / km	kg/km	mm	mm	appr. mm	appr. kg / km
1 x 16	5.187,99	160	0,16	1,2	8,0	180
1 x 25	6.949,88	250	0,16	1,2	9,5	270
1 x 35	8.798,98	350	0,16	1,2	10,5	370
1 x 50	12.675,79	500	0,16	1,2	12,5	530
1 x 70	16.070,70	700	0,16	1,5	14,5	710
1 x 95	20.959,19	950	0,16	1,5	16,5	960
1 x 120	25.123,14	1.200	0,21	1,8	18,5	1.180
1 x 150	30.893,23	1.500	0,21	2,0	20,5	1.570

Solar-Cable Sheathed Cable for Photo-Voltaic Systems

Application: Cable for fixed installations of photo-voltaic systems in- and outdoors.

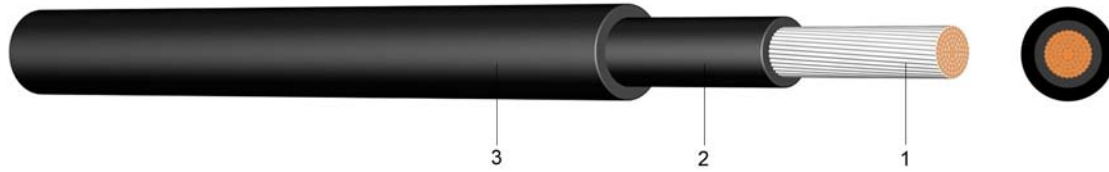

Construction:
 1 fine-stranded tinned copper
 2 core insulation of XPE or EPR rubber
 3 outer sheath of XPE or polyurethane (PUR), black

Information: More cross-sections on enquiry.

Standards: DIN EN 60228 class 5 (construction)
 EN 60811
 EN 50267-2-1
 EN 50363

Technical data:

Nominal voltage U_0/U		[V]	1000 Volt
Test voltage		[V] _{AC}	4000
Temperature range	in motion		-40°C till +120°C
Bending radius	one time / fixed	x diameter	6

Number of cores and nominal cross section mm ²	Price EUR / km	Copper figure kg/km	Cond. construction (appr. value) mm	Overall diameter appr. mm	Weight appr. kg / km
1 x 2,5	1.536,08	25	56 x 0,30	6,0	45
1 x 4	2.354,19	40	56 x 0,30	6,7	60
1 x 6	3.066,03	60	84 x 0,30	7,1	79
1 x 10	6.141,16	100	84 x 0,30	8,8	130

H05RNH2-F Illumination Flat Cable

Application: This cable is used in dry, humid and wet locations, as well as outdoors as a clamping cable for standardised lamp holders for the illumination of spaces and gardens.

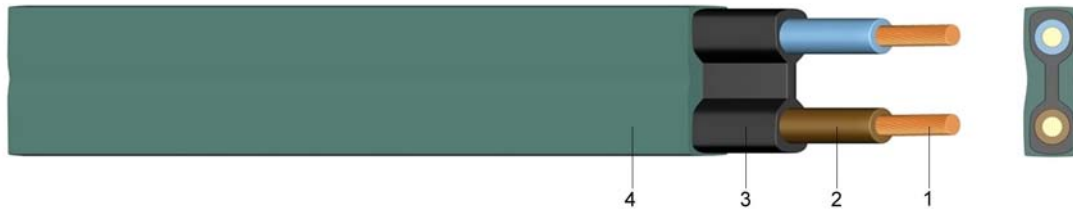

Construction:

- 1 fine-stranded tinned copper
- 2 ethylene propylene rubber (NR) or styrene-butadiene rubber (SBR) insulation
- 3 polychloroprene (CR) inner sheath
- 4 polychloroprene (CR) outer sheath, green

Standards: DIN VDE 0282
DIN EN 60228 class 5 (construction)
HD 22.6 S2:1994+A1:1999+A2:2004

Technical data:

Nominal voltage U ₀ /U		[V]	300 / 500 Volt
Test voltage		[V] _{AC}	2000
Temperature range	in motion		-25°C till +50°C
Operating temperature	short circuit	°C	200
Short circuit time	max.	[sec]	5
Bending radius	min.	x diameter	6
Flammability	standard		EN 60332-1-2

Number of cores and nominal cross section mm ²	Price EUR / km	Copper figure kg/km	Cond. construction (appr. value) mm	Overall measures appr. mm	Weight appr. kg/km
2 x 1,5	2.005,25	30	30 x 0,26	6,0 x 14,0	130
2 x 2,5	3.123,64	50	50 x 0,26	6,5 x 14,5	145

NSHTöu

Rubber Sheathed Cable for Reeling Purposes Crane Cable

Application:

It is to be used in dry and humid locations as well as in the open-air for frequent reeling processes and when the cable is exposed to heavy tensile and torsion load as well as to forced bending as in the case of cable carriages, line chains, drums or other mechanical equipment. Travel speed up to 120 m/min.

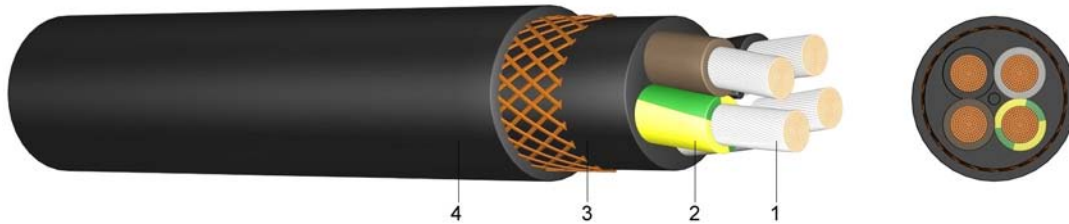

Construction:

- 1 fine-stranded tinned copper
- 2 core insulation of rubber compound (EPR)
- 3 inner sheath of rubber (5GM2) with open plaiting out of plastic threads to protect the cable from torsion
- 4 outer sheath of polychloroprene (5GM2), black, oil resistant and flame retardant

Standards:

DIN VDE 0250-814
 DIN EN 60228 class 5 (construction)
 HD 308 S2 (core identification)
 DIN VDE 0293-1

Technical data:

Nominal voltage U ₀ /U		[V]	600 / 1000 Volt
Test voltage		[V] _{ac}	4000
Temperature range	in motion		-20°C till +90°C
Operating temperature	short circuit	°C	200
Short circuit time	max.	[sec]	5
Bending radius	min.	x diameter	8
Oil-resistant	standard		EN 60811-2-1
Flammability	standard		EN 60332-1-2

Number of cores and nominal cross section mm ²	Price EUR / km	Copper figure kg/km	Cond. construction (appr. value) mm	Overall diameter appr. mm	Weight appr. kg / km
4 x 1,5	7.310,19	60	44 x 0,21	11,8	222
5 x 1,5	8.729,41	75	44 x 0,21	12,7	260
7 x 1,5	12.004,21	105	44 x 0,21	16,0	380
12 x 1,5	15.586,79	180	44 x 0,21	22,0	720
18 x 1,5	22.119,93	270	44 x 0,21	22,1	770
24 x 1,5	27.982,70	360	44 x 0,21	26,1	1.000
30 x 1,5	32.423,57	450	44 x 0,21	29,5	1.320
4 x 2,5	10.321,36	100	73 x 0,21	14,4	335
5 x 2,5	12.740,97	125	73 x 0,21	15,4	390
7 x 2,5	15.693,24	175	73 x 0,21	17,9	505

Number of cores and nominal cross section mm²	Price EUR / km	Copper figure kg/km	Cond. construction (appr. value) mm	Overall diameter appr. mm	Weight appr. kg / km
12 x 2,5	23.516,54	300	73 x 0,21	25,0	970
18 x 2,5	32.302,43	450	73 x 0,21	25,9	1.100
24 x 2,5	42.993,59	600	73 x 0,21	30,8	1.450
30 x 2,5	46.379,03	750	73 x 0,21	34,9	1.950
4 x 4	13.766,99	160	75 x 0,26	16,0	435
4 x 6	17.221,10	240	119 x 0,26	17,4	530
4 x 10	23.070,91	400	196 x 0,26	21,3	830
4 x 16	29.643,23	640	210 x 0,31	24,7	1.170
4 x 25	41.444,92	1.000	336 x 0,31	31,4	1.830
4 x 35	53.853,29	1.400	475 x 0,31	33,9	2.280
4 x 50	71.338,42	2.000	684 x 0,31	40,2	3.220
4 x 70	92.833,82	2.800	551 x 0,41	44,5	4.200
4 x 95	118.333,42	3.800	722 x 0,41	51,0	5.530
5 x 4	15.255,36	200	75 x 0,26	17,3	520
5 x 6	19.521,00	300	119 x 0,26	19,7	690
5 x 10	25.732,28	500	196 x 0,26	23,1	1.000
5 x 16	32.068,22	800	210 x 0,31	26,8	1.400
5 x 35	58.258,77	1.750	475 x 0,31	38,3	2.950

NSHTöu(SMK) Rubber Sheathed Cable for Cordaflex Reeling Purposes Crane Cable

Application: It is to be used as a connection cable for reeling purposes for very high mechanical loads on movable appliances, mobile line carriers, cable carriages as well as for vertical drum operation. It is also applicable for the scope of DIN VDE 0168 and 0118, for underground and open-cast mines.

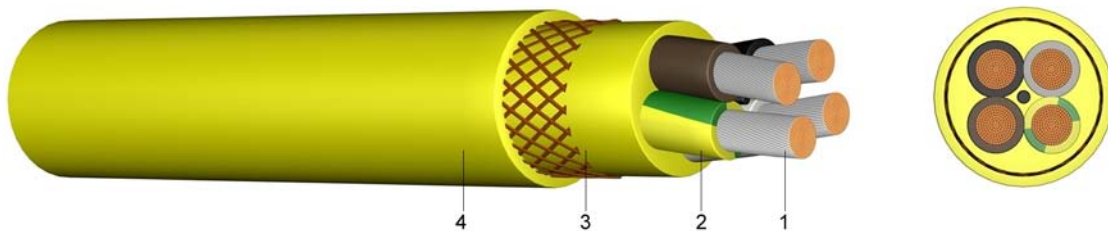

Construction:

- 1 fine-stranded tinned copper
- 2 PROTOLON insulated cores
- 3 inner sheath of a special compound polychloroprene (PCP), antitorsion braid made of polyester threads , in a vulcanised bond
- 4 outer sheath of wear- and tear-resistant PCP compound, yellow, oil-, weather- and water resistant

Standards: adapted to DIN VDE 0250-814
 DIN EN 60228 class 5 (construction)
 HD 308 S2 (core identification)

Technical data:

Nominal voltage U ₀ /U		[V]	600 / 1.000 Volt
Test voltage		[V] _{AC}	2500
Temperature range	in motion		-35°C till +60°C
	fixed		-50°C till +80°C
Operating temperature	short circuit	°C	250
Short circuit time	max.	[sec]	5
Bending radius	min.	x diameter	8
Oil-resistant	standard		EN 60811-2-1
Flammability	standard		EN 60332-1-2

Number of cores and nominal cross section mm ²	Price EUR / km	Copper figure kg/km	Cond. construction (appr. value) mm	Overall diameter appr. mm	Overall diameter max. value appr. mm	Weight appr. kg / km
5 x 1,5	11.862,20	75	50 x 0,21	13,0	14,6	280
7 x 1,5	16.550,89	105	50 x 0,21	15,2	17,2	385
12 x 1,5	21.348,08	180	50 x 0,21	21,4	23,4	710
24 x 1,5	37.458,43	378	50 x 0,21	23,8	26,8	990
4 x 2,5	14.420,74	100	80 x 0,21	13,2	14,8	305
7 x 2,5	21.777,89	175	80 x 0,21	16,6	18,6	510
12 x 2,5	31.665,28	300	80 x 0,21	23,4	25,4	920

Number of cores and nominal cross section mm ²	Price	Copper figure	Cond. construction (appr. value) mm	Overall diameter appr. mm	Overall diameter max. value appr. mm	Weight
	EUR / km	kg/km				appr. kg / km
18 x 2,5	42.865,12	450	80 x 0,21	23,3	25,3	1.005
24 x 2,5	58.212,91	600	80 x 0,21	26,2	29,2	1.320
19 x 2,5+5x1(C)	62.582,64	657	80 x 0,21	26,2	29,2	1.290
25 x 2,5+5x1(C)	72.593,03	812	80 x 0,21	29,4	32,4	1.620
30 x 2,5	61.670,46	750	80 x 0,21	29,4	32,4	1.660
4 x 6	20.878,96	240	120 x 0,26	17,4	19,4	575
4 x 10	29.590,43	442	210 x 0,26	21,6	23,6	905
4 x 16	37.471,69	640	230 x 0,31	23,7	26,7	1.240
4 x 25	56.331,28	1.000	360 x 0,31	28,5	31,5	1.850
5 x 6	27.444,23	300	120 x 0,26	19,0	21,0	690
3 x 35+3x16/3	72.843,88	1.269	510 x 0,31	34,4	37,4	2.160
3 x 50+3x25/3	97.999,91	1.835	530 x 0,31	39,7	42,7	2.850
3 x 70+3x35/3	127.303,90	2.450	730 x 0,36	39,7	42,7	3.920
3 x 95+3x50/3	170.430,53	3.350	780 x 0,41	44,3	47,3	5.020
3 x 120+3x70/3	186.050,00	4.300	1000 x 0,41	51,0	55,0	6.630

(N)FLGöu (STN)

Rubber Control Cable with Supporting Element for Medium-Level Mechanical Stress

Application:

To be used in dry, humid and wet locations as well as in the open-air as a flexible power and control cable for medium-level mechanical loads. This cable is suitable for connecting movable parts of machine tools, material handling equipment and large machines.

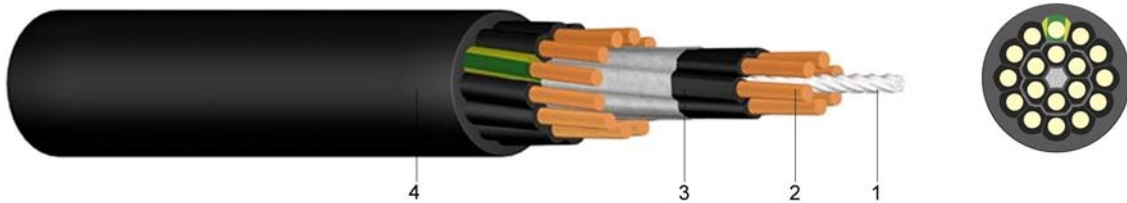

Construction:

- 1 supporting element out of cord
- 2 fine-stranded bare copper
- 3 core insulation of a rubber compound
- 4 outer sheath of rubber (5GM1), black

Standards:

adapted to DIN VDE 0250
DIN EN 60228 class 6 (construction)
Core identification: 1 core green/yellow, all other cores black with figures

Technical data:

Nominal voltage U ₀ /U		[V]	450 / 750 Volt
Test voltage		[V] _{Ac}	2500
Temperature range	in motion		-25°C till +60°C
Operating temperature	short circuit	°C	250
Short circuit time	max.	[sec]	5
Bending radius	one time / fixed	x diameter	4
Bending radius	in motion	x diameter	5
Flammability	standard		EN 60332-1-2

Number of cores and nominal cross section mm ²	Price EUR / km	Copper figure kg/km	Cond. construction (appr. value) mm	Overall diameter appr. mm	Weight appr. kg / km
7 x 1	5.116,15	70	56 x 0,16	14,0	220
12 x 1	8.703,94	120	56 x 0,16	19,0	430
18 x 1	11.648,94	180	56 x 0,16	20,0	510
24 x 1	14.635,13	240	56 x 0,16	23,0	670
36 x 1	20.362,47	360	56 x 0,16	26,0	900
48 x 1	25.935,12	480	56 x 0,16	30,0	1.220
4 x 1,5	4.902,80	60	84 x 0,16	11,0	180
5 x 1,5	5.137,50	75	84 x 0,16	12,0	200
7 x 1,5	5.730,62	105	84 x 0,16	15,0	280
9 x 1,5	6.936,35	135	84 x 0,16	18,0	400
12 x 1,5	9.914,48	180	84 x 0,16	20,0	540
18 x 1,5	12.796,87	270	84 x 0,16	21,0	600
24 x 1,5	16.993,95	360	84 x 0,16	25,0	840
4 x 2,5	6.226,35	100	140 x 0,16	14,0	250
7 x 2,5	7.581,97	175	140 x 0,16	17,5	380
12 x 2,5	13.371,66	300	140 x 0,16	22,5	710

NGFLGöu

Rubber Flat Cable for Medium-Level Mechanical Stress

Application:

It is to be used in dry, humid and wet locations as well as in the open-air as a flexible power and control cable for medium-level mechanical loads. This cable is suitable for connecting movable parts of machine tools, material handling equipment and large machines provided it is exposed to bending in only one plane. Cores grouped with individual groups separated by a stay

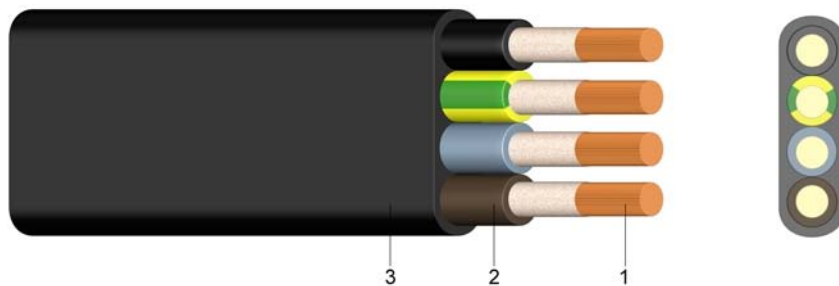

Construction:

- 1 fine-stranded bare copper
- 2 core insulation of a rubber compound (3GI3), laid up parallel
- 3 outer sheath out of a rubber compound (5GM3), black, flame retardant

Standards:

DIN VDE 0250-809
DIN EN 60228 class 5 and 6 (construction)
HD 308 S2 (core identification)

Technical data:

Nominal voltage U ₀ /U	[V]	300 / 500 Volt
Test voltage	[V] _{Ac}	2000
Temperature range	in motion fixed	-25°C till +60°C -40°C till +80°C
Operating temperature	short circuit	°C 200
Short circuit time	max.	[sec] 5
Bending radius	one time / fixed	x diameter 3
Bending radius	in motion	x diameter 5
Flammability	standard	EN 60332-1-2

Number of cores and nominal cross section mm ²	Price EUR / km	Copper figure kg/km	Cond. construction (appr. value) mm	Overall measures appr. mm	Weight appr. kg / km
4 x 1,5	3.368,43	60	84 x 0,16	6,2 x 17,5	200
5 x 1,5	4.333,24	75	84 x 0,16	6,2 x 21,5	240
7 x 1,5	5.757,24	105	84 x 0,16	6,2 x 29,0	360
8 x 1,5	6.930,64	120	84 x 0,16	6,2 x 31,5	370
12 x 1,5	10.403,05	180	84 x 0,16	6,5 x 47,0	620
24 x 1,5	26.454,72	360	84 x 0,16	13,5 x 56,0	1.010
4 x 2,5	4.541,63	100	140 x 0,16	7,5 x 21,0	280
5 x 2,5	5.643,93	125	140 x 0,16	7,5 x 27,0	400
7 x 2,5	7.569,19	175	140 x 0,16	7,5x 35,0	520
8 x 2,5	8.832,47	200	140 x 0,16	7,5 x 39,0	550
12 x 2,5	13.042,73	300	140 x 0,16	8,0 x 56,0	800
24 x 2,5	33.304,59	600	140 x 0,16	17,0 x 72,5	1.690
4 x 4	6.760,44	160	224 x 0,16	9,0 x 26,0	410
4 x 6	8.931,86	240	192 x 0,21	9,5 x 29,0	600
4 x 10	12.177,02	400	320 x 0,21	11,0 x 33,0	800

Number of cores and nominal cross section mm ²	Price	Copper figure	Cond. construction (appr. value)	Overall measures	Weight
	EUR / km	kg/km	mm	appr. mm	appr. kg / km
4 x 16	19.122,02	640	512 x 0,21	13,0 x 38,0	1.150
4 x 25	27.688,95	1.000	800 x 0,21	15,0 x 49,5	1.700
4 x 35	35.428,64	1.400	280 x 0,41	17,0 x 55,0	2.200
5 x 4	9.664,82	200	224 x 0,16	9,0 x 32,0	560
5 x 6	11.263,88	300	192 x 0,21	9,5 x 35,0	650
5 x 16	26.189,66	800	512 x 0,21	13,0 x 50,0	1.450
7 x 4	12.498,51	280	224 x 0,16	9,0 x 42,0	700
7 x 6	18.592,08	420	192 x 0,21	9,5 x 44,5	850
7 x 10	28.174,06	700	320 x 0,21	12,1 x 63,5	1.350

H07VVH6-F PVC Flat Cable for Medium-Level Mechanical Stress

Application:

To be used in dry and humid locations but not in the open-air for low and medium-level mechanical loads. This cable is suitable for connecting movable parts of machine tools, material handling equipment and large machines provided it is exposed to bending in only one plane. Cables with more than 5 cores grouped with individual groups separated by a stay.

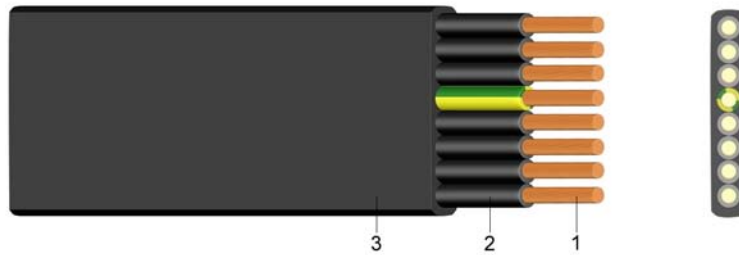

Construction:

- 1 fine-stranded bare copper
- 2 core insulation of polyvinylchloride (PVC), cores are laid up parallel
- 3 outer sheath of soft polyvinylchloride (PVC), black

Standards:

DIN VDE 0281-404
 DIN EN 60228 class 5 (construction)
 HD 308 S2 (core identification)

Technical data:

Nominal voltage U ₀ /U		[V]	450 / 750 Volt
Test voltage		[V] _{Ac}	2500
Temperature range	in motion		-5°C till +70°C
Operating temperature	short circuit	°C	160
Short circuit time	max.	[sec]	5
Bending radius	min.	x diameter	10
Flammability	standard		EN 60332-1-2

Number of cores and nominal cross section mm ²	Price	Copper figure	Cond. construction (appr. value) mm	Overall measures	Weight
	EUR / km	kg/km		appr. mm	appr. kg/km
4 G 1,5	1.507,48	60	30 x 0,26	5,0 x 15,0	150
5 G 1,5	1.877,48	75	30 x 0,26	5,0 x 18,0	180
7 G 1,5	2.638,19	105	30 x 0,26	5,0 x 27,0	265
8 G 1,5	2.972,56	120	30 x 0,26	5,0 x 29,0	295
10 G 1,5	3.769,07	150	30 x 0,26	5,0 x 36,0	355
12 G 1,5	4.312,28	180	30 x 0,26	5,0 x 41,0	415
4 G 2,5	2.356,47	100	50 x 0,26	5,7 x 18,5	250
5 G 2,5	3.043,53	125	50 x 0,26	5,7 x 22,0	280
7 G 2,5	4.033,49	175	50 x 0,26	5,7 x 33,5	385
8 G 2,5	4.521,32	200	50 x 0,26	5,7 x 37,0	430
12 G 2,5	6.637,36	300	50 x 0,26	5,7 x 51,0	630
4 G 4	3.410,54	160	56 x 0,31	6,9 x 21,5	320
5 G 4	4.544,07	200	56 x 0,31	6,9 x 26,0	390
7 G 4	5.959,11	280	56 x 0,31	6,9 x 38,0	560
4 G 6	4.579,70	240	84 x 0,31	7,6 x 24,5	430
5 G 6	7.133,45	300	84 x 0,31	7,6 x 29,5	530
4 G 10	8.179,17	400	80 x 0,41	9,6 x 31,0	690

Number of cores and nominal cross section mm²	Price EUR / km	Copper figure kg/km	Cond. construction (appr. value) mm	Overall measures appr. mm	Weight appr. kg/km
4 G 16	11.568,25	640	128 x 0,41	10,9 x 35,5	970
4 G 25	19.523,81	1.000	200 x 0,41	12,7 x 41,5	1.405
4 G 35	26.047,49	1.400	280 x 0,41	15,7 x 49,0	2.035
4 G 50	34.369,85	2.000	400 x 0,41	19,1 x 61,5	3.000

XYMM K 35 PVC Building Site Cable

Application: This cable is suitable for connecting electrical equipment particularly on building sites. It is used in dry and damp locations, outdoors and in areas with explosion hazard.



Construction:
 1 fine-stranded copper
 2 core insulation of cold-resistant polyvinylchloride(PVC)
 3 outer sheath of polyvinylchloride (PVC), yellow

Information: Cable may be used only in Austria as a building site cable.

According to: adapted to ÖVE-K41
 DIN EN 60228 class 5 (construction)
 HD 308 S2 (core identification)

Technical data:

Nominal voltage U ₀ /U	[V]	450 / 750 Volt
Test voltage	[V] _{ac}	2500
Temperature range	in motion	-35°C till +70°C
Operating temperature	short circuit	150
Short circuit time	max. [sec]	5
Bending radius	min. x diameter	6
Flammability	standard	EN 60332-1-2

Number of cores and nominal cross section mm ²	Price EUR / km	Copper figure kg/km	Cond. construction (appr. value) mm	Overall diameter appr. mm	Weight appr. kg / km
3 x 1,5	1.346,59	45	30 x 0,26	7,7	96
4 x 1,5	1.719,18	60	30 x 0,26	8,7	119
5 x 1,5	2.255,89	75	30 x 0,26	9,9	159
3 x 2,5	2.717,13	75	50 x 0,26	9,8	157
4 x 2,5	3.296,98	100	50 x 0,26	10,4	184
5 x 2,5	4.152,37	125	50 x 0,26	11,6	221
5 x 4	6.584,38	200	56 x 0,31	16,0	407
5 x 6	9.676,50	300	84 x 0,31	19,0	580
5 x 10	14.085,26	500	80 x 0,41	24,7	1.020
5 x 16	20.131,73	800	128 x 0,41	28,3	1.400

N07V3V3-F PVC Building Site Cable

Application: This cable is suitable for connecting electrical equipment particularly on building sites. It is used in dry and damp locations, outdoors and in areas with explosion hazard.



Construction:

- 1 fine-stranded bare copper
- 2 core insulation of cold-resistant polyvinylchloride(PVC)
- 3 outer sheath of cold-resistant polyvinylchloride (PVC), yellow

Standards:

- HD 21.13.S1 1995
- ÖNORM E8241-55
- DIN EN 60228 class 5 (construction)
- HD 308 S2 (core identification)

Technical data:

Nominal voltage U ₀ /U	[V]	450 / 750 Volt
Test voltage	[V] _{AC}	2500
Temperature range	in motion	-35°C till +70°C
Operating temperature	short circuit	°C
Short circuit time	max.	[sec]
Bending radius	min.	x diameter
Flammability	standard	EN 60332-1-2

Number of cores and nominal cross section mm ²	Price	Copper figure	Cond. construction (appr. value) mm	Overall diameter appr. mm	Weight appr. kg / km
	EUR / km	kg/km			
2 X 1,5	1.166,83	30	30 x 0,26	9,0	85
3 G 1,5	1.346,59	45	30 x 0,26	10,5	132
4 G 1,5	1.719,18	60	30 x 0,26	11,6	161
5 G 1,5	2.255,89	75	30 x 0,26	12,8	185
3 G 2,5	2.717,13	75	50 x 0,26	12,4	197
4 G 2,5	3.296,98	100	50 x 0,26	13,8	238
5 G 2,5	4.152,37	125	50 x 0,26	15,2	291
5 G 4	6.584,38	200	56 x 0,31	17,8	420
5 G 6	9.676,50	300	84 x 0,31	19,9	598
5 G 10	14.085,26	500	80 x 0,41	26,0	1.051
5 G 16	20.131,73	800	128 x 0,41	29,9	1.442

H05BQ-F

Polyurethane Building Site Cable with Rubber Insulated Conductors

Application:

This termination and connection cable with high mechanical stress-resistance can be used in dry, damp or wet rooms as well as in the open-air. It is ideal for application in industrial plants, building sites, in fact everywhere where extreme wear and tear resistance is required and where the cable is subjected to hard utilisation.



Construction:

- 1 fine-stranded tinned or bare copper
- 2 core insulation of a rubber compound (EL6)
- 3 outer sheath of polyurethane (PUR), orange

Standards:

DIN VDE 0282-10
DIN EN 60228 class 5 (construction)
HD 308 S2 (core identification)
HD 22.10 S1+A1

Technical data:

Nominal voltage U ₀ /U		[V]	300 / 500 Volt
Test voltage		[V] _{Ac}	2000
Temperature range	in motion		-40°C till +90°C
Operating temperature	short circuit	°C	200
Short circuit time	max.	[sec]	5
Bending radius	one time / fixed	x diameter	4
Bending radius	in motion	x diameter	5
Oil-resistant	standard		EN 60811-2-1
Flammability	standard		EN 60332-1-2

Number of cores and nominal cross section mm ²	Price EUR / km	Copper figure kg/km	Cond. construction (appr. value) mm	Overall diameter appr. mm	Weight appr. kg / km
2 X 0,75	1.845,71	15,0	24 x 0,21	6,8	51
3 G 0,75	1.977,63	22,5	24 x 0,21	7,4	66
4 G 0,75	2.307,58	30,0	24 x 0,21	7,9	79
5 G 0,75	2.854,63	37,5	24 x 0,21	8,8	97
2 X 1	1.943,68	20,0	30 x 0,21	7,4	61
3 G 1	2.091,78	30,0	30 x 0,21	7,8	76
4 G 1	2.601,31	40,0	30 x 0,21	8,4	92
5 G 1	3.215,73	50,0	30 x 0,21	9,4	116

H07BQ-F

Polyurethane Building Site Cable with Rubber Insulated Conductors

Application:

This termination and connection cable with high mechanical stress-resistance can be used in dry, damp or wet rooms as well as in the open-air. It is ideal for application in industrial plants, building sites, in fact everywhere where extreme wear and tear resistance is required and where the cable is subjected to hard utilisation.



Construction:

- 1 fine-stranded tinned or bare copper
- 2 core insulation of a rubber compound (EL6)
- 3 outer sheath of polyurethane (PUR), orange

Information:

with or without inner sheath available

Standards:

DIN VDE 0282-10
 HD 22.10 S1+A1
 DIN EN 60228 class 5 (construction)
 HD 308 S2 (core identification)

Technical data:

Nominal voltage U ₀ /U		[V]	450 / 750 Volt
Test voltage		[V] _{Ac}	2500
Temperature range	in motion		-40°C till +90°C
Operating temperature	short circuit	°C	200
Short circuit time	max.	[sec]	5
Bending radius	one time / fixed	x diameter	4
Bending radius	in motion	x diameter	5
Oil-resistant	standard		EN 60811-2-1
Flammability	standard		EN 60332-1-2

Number of cores and nominal cross section mm ²	Price EUR / km	Copper figure kg/km	Cond. construction (appr. value) mm	Overall diameter appr. mm	Weight appr. kg / km
2 X 1,5	2.369,07	30	30 x 0,26	8,8	88
3 G 1,5	2.665,54	45	30 x 0,26	9,3	110
4 G 1,5	3.406,23	60	30 x 0,26	10,3	140
5 G 1,5	3.813,66	75	30 x 0,26	11,2	169
7 G 1,5	8.972,95	105	30 x 0,26	14,0	291
3 G 2,5	4.114,06	75	50 x 0,26	11,0	163
4 G 2,5	4.745,58	100	50 x 0,26	12,2	208
5 G 2,5	6.099,04	125	50 x 0,26	13,5	257
7 G 2,5	11.989,68	175	50 x 0,26	16,5	431
4 G 4	7.743,52	160	56 x 0,31	14,0	293
5 G 4	9.970,60	200	56 x 0,31	15,6	365
5 G 6	13.612,46	300	84 x 0,31	17,6	504
5 G 10	18.917,61	500	80 x 0,41	23,2	962
5 G 16	26.246,17	800	128 x 0,41	27,1	1.379
5 G 25	36.453,01	1.250	200 x 0,41	33,3	2.169

Number of cores and nominal cross section mm²	Price EUR / km	Copper figure kg/km	Cond. construction (appr. value) mm	Overall diameter appr. mm	Weight appr. kg / km
07BQ-F					
7 G 1,5	8.972,95	105	30 x 0,26	14,0	291
7 G 2,5	11.989,68	175	50 x 0,26	16,5	431
12 G 1,5	16.223,01	180	30 x 0,26	18,0	446
12 G 2,5	20.255,63	300	50 x 0,26	21,0	641

YSLY

PVC Control Cable

Application:

In dry and damp locations for low and medium-level mechanical stress, but not in the open-air. To be used as a termination and connection cable in the control, measuring and signal technology. Suitable as a signal and impulse cable for control and inspection of industrial plants, production lines and machinery.

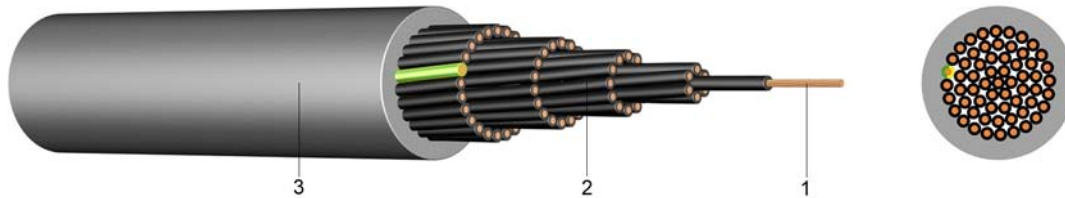

Construction:

- 1 fine-stranded bare copper
- 2 core insulation of polyvinylchloride (PVC)
- 3 outer sheath of polyvinylchloride (PVC), grey, increased oil resistant

Standards:

adapted to DIN VDE 0281
 DIN EN 60228 class 5 (construction)
 HD 308 S2 (core identification for coloured cores)
 core identification JZ: 1 core green/yellow, other cores black with figures
 core identification OZ: every core black with figures

Technical data:

Nominal voltage U ₀ /U		[V]	300 / 500 Volt
Test voltage		[V] _{AC}	2000
Temperature range	in motion		-5°C till +70°C
	fixed		-30°C till +70°C
Operating temperature	short circuit	°C	150
Short circuit time	max.	[sec]	5
Bending radius	one time / fixed	x diameter	6
Bending radius	in motion	x diameter	15
Flammability	standard		EN 60332-1-2

Number of cores and nominal cross section mm ²	Price EUR / km J	Price EUR / km O	Copper figure kg/km	Cond. construction (app.value)mm	Overall diameter appr.mm	Weight appr. kg / km
2 x 0,5		492,40	10,0	16 x 0,21	4,8	35
3 x 0,5 *	561,38	617,51	15,0	16 x 0,21	5,1	41
4 x 0,5	681,46	749,65	20,0	16 x 0,21	5,7	49
5 x 0,5	813,15		25,0	16 x 0,21	6,2	60
7 x 0,5 *	1.153,70	1.269,10	35,0	16 x 0,21	6,7	77
10 x 0,5	2.072,60		50,0	16 x 0,21	8,6	114
12 x 0,5	2.234,33		60,0	16 x 0,21	8,9	128
14 x 0,5	2.484,71		70,0	16 x 0,21	9,5	149
16 x 0,5	3.005,85		80,0	16 x 0,21	10,0	164
18 x 0,5	3.143,64		90,0	16 x 0,21	10,5	185
21 x 0,5	3.674,36		105,0	16 x 0,21	11,7	219
25 x 0,5	4.444,70		125,0	16 x 0,21	12,6	256
30 x 0,5	4.829,27		150,0	16 x 0,21	13,5	310
34 x 0,5	5.480,99		170,0	16 x 0,21	14,3	331
40 x 0,5	6.100,38		200,0	16 x 0,21	15,2	409
50 x 0,5	8.598,28		250,0	16 x 0,21	17,2	510
61 x 0,5	10.170,08		305,0	16 x 0,21	18,5	595

Number of cores and nominal cross section mm ²	Price	Price	Copper figure kg/km	Cond. construction (app.value) mm	Overall diameter appr. mm	Weight appr. kg / km
	EUR / km J	EUR / km O				
2 x 0,75 *		523,05	15,0	24 x 0,21	5,3	42
3 x 0,75 *	626,79	689,51	22,5	24 x 0,21	5,5	50
4 x 0,75 *	777,51	855,26	30,0	24 x 0,21	6,2	64
5 x 0,75	968,00	1.064,85	37,5	24 x 0,21	6,7	77
6 x 0,75	1.145,32		43,0	24 x 0,21	7,1	95
7 x 0,75 *	1.301,07	1.431,13	52,5	24 x 0,21	7,4	99
10 x 0,75	2.140,88	2.355,01	75,0	24 x 0,21	9,4	160
12 x 0,75	2.381,68	2.619,85	90,0	24 x 0,21	9,7	165
15 x 0,75	3.026,23		112,5	24 x 0,21	10,9	210
16 x 0,75	3.026,23		120,0	24 x 0,21	11,5	240
18 x 0,75	3.263,44		135,0	24 x 0,21	11,8	240
21 x 0,75	4.118,84		157,5	24 x 0,21	12,8	282
25 x 0,75	4.705,87	4.705,87	187,5	24 x 0,21	13,9	333
34 x 0,75	6.046,47		255,0	24 x 0,21	15,9	435
41 x 0,75	8.553,95		307,5	24 x 0,21	17,4	535
42 x 0,75	9.369,19		315,0	24 x 0,21	17,8	547
50 x 0,75	10.352,19		375,0	24 x 0,21	19,2	643
80 x 0,75	16.275,26		600,0	24 x 0,21	23,6	1.005
2 x 1 *		596,62	20,0	32 x 0,21	5,5	50
3 x 1 *	721,94	794,08	30,0	32 x 0,21	5,9	61
4 x 1 *	897,19	986,93	40,0	32 x 0,21	6,5	75
5 x 1 *	1.099,80	1.209,79	50,0	32 x 0,21	7,1	95
7 x 1	1.568,22	1.725,05	70,0	32 x 0,21	8,0	114
9 x 1	2.252,30		90,0	32 x 0,21	10,0	156
10 x 1	2.479,94	2.727,92	100,0	32 x 0,21	10,2	179
12 x 1	2.672,81		120,0	32 x 0,21	10,5	211
14 x 1	3.077,74		140,0	32 x 0,21	11,0	244
16 x 1	3.540,18		160,0	32 x 0,21	11,8	280
18 x 1	4.001,43		180,0	32 x 0,21	12,7	303
21 x 1	4.848,43		210,0	32 x 0,21	13,7	339
25 x 1	5.415,10		250,0	32 x 0,21	14,7	395
34 x 1	7.177,41		340,0	32 x 0,21	17,0	536
41 x 1	8.612,00		410,0	32 x 0,21	18,9	674
42 x 1	9.026,18		420,0	32 x 0,21	19,0	680
50 x 1	10.746,35		500,0	32 x 0,21	20,7	823
61 x 1	13.111,45		610,0	32 x 0,21	22,2	951
2 x 1,5 *		718,49	30,0	30 x 0,26	6,3	63
3 x 1,5 *	886,73	975,41	45,0	30 x 0,26	6,6	79
4 x 1,5 *	1.137,68	1.251,43	60,0	30 x 0,26	7,3	98
5 x 1,5 *	1.404,10	1.544,54	75,0	30 x 0,26	8,1	123
6 x 1,5	1.729,96		90,0	30 x 0,26	8,5	155
7 x 1,5	1.876,12	2.063,76	105,0	30 x 0,26	8,9	161
8 x 1,5	2.422,17		120,0	30 x 0,26	10,6	188
9 x 1,5	2.749,89		135,0	30 x 0,26	11,0	220
10 x 1,5	2.969,92		150,0	30 x 0,26	11,3	237
12 x 1,5	3.431,17		180,0	30 x 0,26	11,8	277
14 x 1,5	4.157,17		210,0	30 x 0,26	12,6	319
16 x 1,5	4.535,75		240,0	30 x 0,26	13,4	364
18 x 1,5	4.944,28		270,0	30 x 0,26	14,2	411
21 x 1,5	6.262,11		315,0	30 x 0,26	15,4	476
25 x 1,5	6.431,03		375,0	30 x 0,26	16,7	566
26 x 1,5	6.656,41		390,0	30 x 0,26	17,3	584
32 x 1,5	8.733,53		480,0	30 x 0,26	18,7	717
34 x 1,5	9.097,86		510,0	30 x 0,26	19,4	741
42 x 1,5	11.080,59		630,0	30 x 0,26	21,6	933
50 x 1,5	13.712,67		750,0	30 x 0,26	23,5	1.102
61 x 1,5	16.258,49		915,0	30 x 0,26	25,2	1.328

Number of cores and nominal cross section mm ²	Price EUR / km		Copper figure kg/km	Cond. construction (appr. value) mm	Overall diameter appr. mm	Weight appr. kg / km
	J	O				
2 x 2,5 *		1.195,64	50,0	48 x 0,26	7,6	101
3 x 2,5 *	1.372,95		75,0	48 x 0,26	8,2	127
4 x 2,5 *	1.681,47		100,0	48 x 0,26	9,0	160
5 x 2,5 *	2.125,68		125,0	48 x 0,26	10,0	197
7 x 2,5	2.901,63		175,0	48 x 0,26	11,1	256
10 x 2,5	4.889,17		250,0	48 x 0,26	14,3	379
12 x 2,5	5.454,63	6.000,16	300,0	48 x 0,26	14,8	447
16 x 2,5	7.196,58		400,0	48 x 0,26	16,7	603
18 x 2,5	8.332,31		450,0	48 x 0,26	17,8	657
25 x 2,5	11.395,68		625,0	48 x 0,26	21,1	887
34 x 2,5	15.225,78		850,0	48 x 0,26	24,6	1.231
50 x 2,5	23.748,58		1.250,0	48 x 0,26	30,0	1.860
2 x 4		2.166,23	80,0	56 x 0,31	9,0	138
3 x 4 *	2.652,44		120,0	56 x 0,31	9,7	181
4 x 4 *	2.874,08		160,0	56 x 0,31	10,7	230
5 x 4 *	3.618,06		200,0	56 x 0,31	11,8	287
7 x 4	4.986,20		280,0	56 x 0,31	13,1	375
2 x 6		3.273,19	120,0	84 x 0,31	10,7	212
3 x 6	3.631,24		180,0	84 x 0,31	11,5	272
4 x 6 *	4.076,90		240,0	84 x 0,31	12,8	353
5 x 6	4.829,27		300,0	84 x 0,31	14,2	431
7 x 6	7.167,82		420,0	84 x 0,31	15,7	561
4 x 10 *	7.131,88		400,0	80 x 0,41	16,2	593
5 x 10 *	11.254,31		500,0	80 x 0,41	18,1	783
7 x 10	13.356,85		700,0	80 x 0,41	20,0	1.080
4 x 16 *	10.419,29		640,0	128 x 0,41	19,1	897
5 x 16 *	14.451,85		800,0	128 x 0,41	21,5	1.117
7 x 16	19.487,18		1.120,0	128 x 0,41	23,7	1.768
4 x 25 *	17.487,67		1.000,0	200 x 0,41	23,5	1.314
5 x 25 *	23.717,43		1.250,0	200 x 0,41	26,2	1.648
7 x 25	32.213,87		1.750,0	200 x 0,41	29,0	2.187
4 x 35 *	24.142,74		1.400,0	280 x 0,41	26,4	1.807
5 x 35 *	30.908,02		1.750,0	280 x 0,41	29,6	2.213
4 x 50 **	35.801,98		2.000,0	400 x 0,41	31,8	2.557
5 x 50 **	41.347,21		2.500,0	400 x 0,41	35,0	2.920
4 x 70 **	49.642,85		2.800,0	350 x 0,51	36,2	3.489
5 x 70 **	59.359,89		3.500,0	350 x 0,51	40,0	3.660
4 x 95 **	62.837,57		3.800,0	485 x 0,51	42,1	4.501
4 x 120 **	72.259,34		4.800,0	580 x 0,51	46,5	5.673

* also with coloured core available from Stock

** only with coloured core available from Stock, with black insulation and white figures on enquiry

More types on enquiry

YSLCY

PVC Control Cable with Copper Braiding

Application:

Suitable as a signal and impulse cable in the control, measuring and signal technology. The copper braiding optimises protection against external interferences, like electromagnetic fields and stray frequencies.

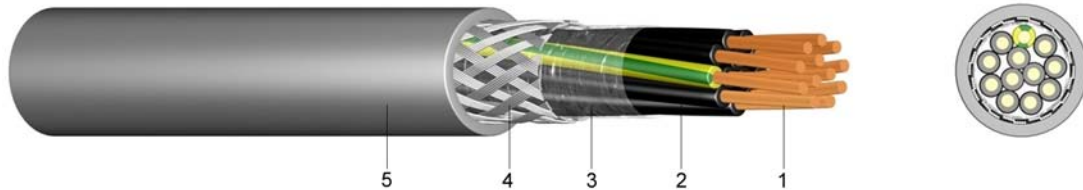

Construction:

- 1 fine-stranded bare copper
- 2 core insulation of polyvinylchloride (PVC)
- 3 wrapped in a plastic foil
- 4 braiding of tinned copper round wires
- 5 outer sheath of polyvinylchloride (PVC), grey, increased oil resistant

Standards:

adapted to DIN VDE 0281
 DIN EN 60228 class 5 (construction)
 HD 308 S2 (core identification for coloured cores)
 core identification JZ: 1 core green/yellow, other cores black with figures
 core identification OZ: every core black with figures

Technical data:

Nominal voltage U ₀ /U		[V]	300 / 500 Volt
Test voltage		[V] _{Ac}	2000
Temperature range	in motion		-5°C till +70°C
	fixed		-30°C till +70°C
Operating temperature	short circuit	°C	150
Short circuit time	max.	[sec]	5
Bending radius	one time / fixed	x diameter	10
Bending radius	in motion	x diameter	20
Flammability	standard		EN 60332-1-2

Number of cores and nominal cross section mm ²	Price EUR / km J	Price EUR / km O	Copper figure kg/km	Cond. construction (app.value) mm	Overall diameter appr.mm	Weight appr. kg / km
2 x 0,5		1.463,99	36	16 x 0,21	5,6	45
3 x 0,5	1.551,45	1.590,01	43	16 x 0,21	5,9	55
4 x 0,5	1.757,51	1.805,63	49	16 x 0,21	6,4	73
5 x 0,5	1.963,58		57	16 x 0,21	7,0	91
12 x 0,5	3.866,05		104	16 x 0,21	9,8	208
25 x 0,5	6.145,91	6.520,90	211	16 x 0,21	13,7	354
2 x 0,75		1.550,25	43	24 x 0,21	6,2	56
3 x 0,75	1.745,54	1.800,61	52	24 x 0,21	6,5	70
4 x 0,75	1.959,98	2.031,97	61	24 x 0,21	7,0	96
5 x 0,75	2.191,19	2.280,71	72	24 x 0,21	7,8	157
7 x 0,75	2.777,04	2.898,81	89	24 x 0,21	8,4	168
10 x 0,75	4.124,82		121	24 x 0,21	10,4	217
12 x 0,75	4.607,63	4.841,57	138	24 x 0,21	10,9	231
18 x 0,75	6.179,45	6.505,87	211	24 x 0,21	12,8	314
25 x 0,75	8.012,43	8.461,13	280	24 x 0,21	15,2	434
34 x 0,75	10.069,46		346	24 x 0,21	17,1	529

Number of cores and nominal cross section mm ²	Price EUR / km J	Price EUR / km O	Copper figure kg/km	Cond. construction (app.value) mm	Overall diameter appr.mm	Weight appr. kg / km
2 x 1		1.608,95	51	32 x 0,21	6,5	83
3 x 1	1.873,72	1.934,69	62	32 x 0,21	6,7	111
4 x 1	2.193,60	2.272,27	74	32 x 0,21	7,4	131
5 x 1	2.513,47	2.622,56	88	32 x 0,21	8,1	155
7 x 1	3.210,72	3.350,23	112	32 x 0,21	8,8	190
12 x 1	5.095,23	5.352,47	185	32 x 0,21	11,5	286
18 x 1	6.722,16	7.118,83	268	32 x 0,21	13,8	393
25 x 1	8.557,54	9.093,77	354	32 x 0,21	16,0	658
34 x 1	10.814,64	11.525,84	458	32 x 0,21	18,4	759
50 x 1	15.805,63		671	32 x 0,21	22,0	994
2 x 1,5 *		1.968,37	65	30 x 0,26	7,1	97
3 x 1,5 *	2.234,33	2.310,78	82	30 x 0,26	7,6	124
4 x 1,5	2.633,28	2.731,88	100	30 x 0,26	8,2	166
5 x 1,5	3.032,22	3.158,71	119	30 x 0,26	9,0	192
7 x 1,5	3.830,11	3.995,01	154	30 x 0,26	9,8	245
12 x 1,5	5.737,37	6.077,48	268	30 x 0,26	13,0	365
18 x 1,5	7.623,07	8.094,98	373	30 x 0,26	15,5	556
25 x 1,5	9.762,76	10.393,75	530	30 x 0,26	18,0	737
27 x 1,5	10.489,18		560	30 x 0,26	20,0	750
34 x 1,5	13.758,20	14.617,81	686	30 x 0,26	20,9	966
50 x 1,5	19.140,96	20.390,28	1.001	30 x 0,26	24,8	1.342
2 x 2,5		2.910,02	92	50 x 0,26	8,5	161
3 x 2,5	3.193,95	3.315,89	118	50 x 0,26	9,0	187
4 x 2,5	3.577,33	3.306,45	147	50 x 0,26	9,9	241
5 x 2,5	3.960,69		176	50 x 0,26	11,0	274
7 x 2,5	5.218,62		253	50 x 0,26	12,0	344
12 x 2,5	8.146,62		408	50 x 0,26	15,9	407
4 x 4	6.565,21		248	56 x 0,31	11,6	307
5 x 4	7.048,01		288	50 x 0,26	12,8	370
2 x 6		6.320,02	170	84 x 0,31	12,5	180
4 x 6	7.769,24		343	84 x 0,31	14,0	402
5 x 6	9.111,03		403	84 x 0,31	15,5	506
4 x 10 *	13.487,45		535	80 x 0,41	17,2	747
5 x 10	15.022,12		635	80 x 0,41	19,3	861
4 x 16	19.059,48		800	128 x 0,41	20,0	1.041
5 x 16	23.002,21		960	128 x 0,41	22,2	1.289
4 x 25	31.615,60		1.280	200 x 0,41	24,7	1.460
5 x 25	33.196,41		1.530	200 x 0,41	27,5	1.840

* also with coloured cores according to HD 308 S2

YSLYQY

PVC Control Cable with Steel Wire Braiding

Application:

Used as a power and control cable with increased mechanical stress-resistance for rough operating conditions. This cable is also suitable for fixed installations in vehicles, machines and hoists, etc.

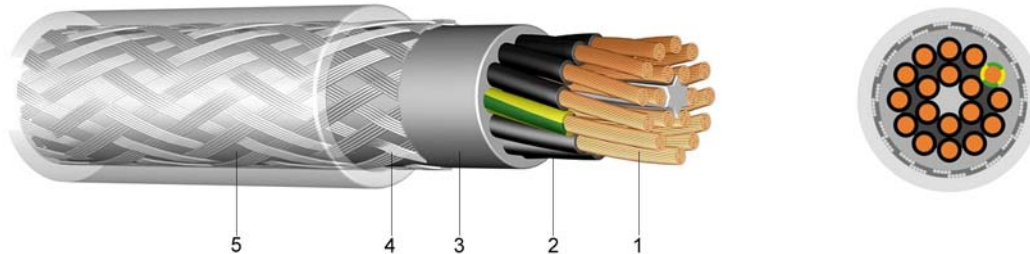

Construction:

- 1 fine-stranded bare copper
- 2 core insulation of polyvinylchloride (PVC)
- 3 inner sheath of polyvinylchloride (PVC)
- 4 braiding of galvanized steel wires
- 5 outer sheath of polyvinylchloride (PVC),
transparent, increased oil resistant

Standards:

adapted to DIN VDE 0281
 DIN EN 60228 class 5 (construction)
 HD 308 S2 (core identification for coloured cores)
 core identification JZ: 1 core green/yellow, other cores black with figures
 core identification OZ: every core black with figures

Technical data:

Nominal voltage U ₀ /U		[V]	300 / 500 Volt
Test voltage		[V] _{AC}	2000
Temperature range	in motion		- 5°C till +70°C
	fixed		-40°C till +70°C
Operating temperature	short circuit	°C	150
Short circuit time	max.	[sec]	5
Bending radius	one time / fixed	x diameter	6
Bending radius	in motion	x diameter	15
Flammability	standard		EN 60332-1-2

Number of cores and nominal cross section mm ²	Price		Copper figure kg/km	Cond. construction (appr. value) mm	Overall diameter appr. mm	Weight appr. kg / km
	EUR / km J	EUR / km O				
2 x 0,75		1.432,17	15,0	24 x 0,21	7,5	73
3 x 0,75	1.550,59		22,5	24 x 0,21	7,8	82
4 x 0,75	1.673,18		30,0	24 x 0,21	8,2	89
5 x 0,75	1.832,29		37,5	24 x 0,21	8,8	101
7 x 0,75	2.335,81		52,5	24 x 0,21	9,1	127
12 x 0,75	3.643,41		90,0	24 x 0,21	11,5	187
18 x 0,75	4.729,67		135,0	24 x 0,21	13,3	258
25 x 0,75	6.179,87		187,5	24 x 0,21	16,3	370
34 x 0,75	7.412,10		255,0	24 x 0,21	18,0	473
50 x 0,75	10.816,37		375,0	24 x 0,21	20,5	649
2 x 1		1.576,17	20,0	32 x 0,21	7,7	79
3 x 1	1.670,50		30,0	32 x 0,21	8,0	90
4 x 1	2.070,85		40,0	32 x 0,21	8,5	106

Number of cores and nominal cross section mm ²	Price	Price	Copper figure kg/km	Cond. construction (appr. value) mm	Overall diameter appr. mm	Weight appr. kg / km
	EUR / km J	EUR / km O				
5 x 1	2.203,92		50,0	32 x 0,21	9,1	119
7 x 1	2.752,68		70,0	32 x 0,21	9,7	145
12 x 1	4.068,08		120,0	32 x 0,21	12,1	226
18 x 1	5.046,74		180,0	32 x 0,21	13,8	311
25 x 1	6.883,92		250,0	32 x 0,21	16,9	438
34 x 1	8.623,97		340,0	32 x 0,21	18,5	561
50 x 1	11.695,81		500,0	32 x 0,21	22,4	794
2 x 1,5		1.567,56	30,0	30 x 0,26	8,3	96
3 x 1,5	1.838,22		45,0	30 x 0,26	8,5	117
4 x 1,5 *	2.063,17		60,0	30 x 0,26	9,2	132
5 x 1,5	2.374,89		75,0	30 x 0,26	9,7	147
7 x 1,5	2.854,81		105,0	30 x 0,26	10,6	184
12 x 1,5	4.404,46		180,0	30 x 0,26	13,5	293
18 x 1,5	5.715,31		270,0	30 x 0,26	16,3	433
25 x 1,5	7.913,52		375,0	30 x 0,26	19,0	572
34 x 1,5	10.511,27		510,0	30 x 0,26	21,2	739
50 x 1,5	14.205,06		750,0	30 x 0,26	28,1	1.227
3 x 2,5	2.420,72		75,0	50 x 0,26	9,7	155
4 x 2,5 *	2.850,62		100,0	50 x 0,26	10,7	191
5 x 2,5	3.246,09		125,0	50 x 0,26	11,5	224
7 x 2,5	4.335,13		175,0	50 x 0,26	12,6	285
12 x 2,5	6.601,62		300,0	50 x 0,26	16,6	460
18 x 2,5	9.377,45		450,0	50 x 0,26	19,3	654
25 x 2,5	12.186,55		625,0	50 x 0,26	23,2	891
4 x 4 *	3.911,63		160,0	56 x 0,31	12,3	271
5 x 4 *	4.827,61		200,0	56 x 0,31	13,8	330
7 x 4	5.985,98		280,0	56 x 0,31	15,4	442
4 x 6	5.465,70		240,0	84 x 0,31	14,5	379
5 x 6 **	6.089,84		300,0	84 x 0,31	16,4	474
7 x 6	8.233,16		420,0	84 x 0,31	17,7	615
4 x 10	8.171,63		400,0	80 x 0,41	18,0	608
7 x 10	14.224,93		700,0	80 x 0,41	21,6	920
4 x 16	11.409,68		640,0	128 x 0,41	21,8	945
5 x 16 **	13.406,44		800,0	128 x 0,41	23,4	1.123
7 x 16	16.866,55		1.120,0	128 x 0,41	26,0	1.494
4 x 25 **	19.725,65		1.000,0	200 x 0,41	25,1	1.349
4 x 35 **	26.243,29		1.400,0	280 x 0,41	29,6	1.839
5 x 35 **	32.027,11		1.750,0	280 x 0,41	32,0	2.197
4 x 50 **	35.986,89		2.000,0	400 x 0,41	34,3	2.605
4 x 70 **	47.037,74		2.800,0	356 x 0,51	38,5	3.453
4 x 95 **	55.731,92		3.800,0	470 x 0,51	43,0	4.544

* also with coloured core on Stock available

** only with coloured core on Stock available, with black insulation and white figures on enquiry

H05VV5-F

PVC Control Cable Oil Resistant

Application:

In dry and wet locations for low and medium-level mechanical stress, but not in the open-air. To be used as a termination and connection cable in the control, measuring and signal technology. Suitable as a signal and impulse cable for control and inspection of industrial plants, production lines and machinery.



Construction:

- 1 fine-stranded bare copper
- 2 core insulation of polyvinylchloride (PVC-mixture YI2)
- 3 outer sheath of polyvinylchloride (PVC-mixture YM2), grey

Standards:

DIN VDE 0281-part 13
 DIN EN 60228 class 5 (construction)
 core identification: 1 core green/yellow, other cores black with figures

Technical data:

Nominal voltage U ₀ /U		[V]	300 / 500 Volt
Test voltage		[V] _{AC}	2000
Temperature range	in motion		-5°C till +70°C
	fixed		-40°C till +70°C
Operating temperature	short circuit	°C	150
Bending radius	one time / fixed	x diameter	12,5
Bending radius	in motion	x diameter	15,0
Oil-resistant	standard		EN 60811-2-1
Flammability	standard		EN 60332-1-2

Number of cores and nominal cross section mm ²	Price	Copper figure	Cond. construction (appr. value)	Overall diameter	Weight
	EUR / km	kg/km	mm	mm	appr. kg / km
2 X 0,75	562,03	15,0	24 x 0,21	6,1	55
3 G 0,75	715,68	22,5	24 x 0,21	6,6	66
4 G 0,75	890,16	30,0	24 x 0,21	7,3	83
5 G 0,75	1.274,45	37,5	24 x 0,21	8,1	102
7 G 0,75	1.917,08	52,5	24 x 0,21	8,9	129
12 G 0,75	2.685,22	90,0	24 x 0,21	11,9	227
18 G 0,75	3.603,29	135,0	24 x 0,21	14,2	329
25 G 0,75	5.478,62	187,5	24 x 0,21	16,5	449
34 G 0,75	7.046,41	255,0	24 x 0,21	19,2	609
50 G 0,75 *	10.111,97	375,0	24 x 0,21	23,2	893
2 X 1	716,49	20,0	32 x 0,21	6,5	63
3 G 1	837,92	30,0	32 x 0,21	6,9	77
4 G 1	1.023,33	40,0	32 x 0,21	7,7	97
5 G 1	1.480,67	50,0	32 x 0,21	8,5	120
7 G 1	2.287,08	70,0	32 x 0,21	9,4	152
12 G 1	3.104,31	120,0	32 x 0,21	12,6	268
18 G 1	4.640,68	180,0	32 x 0,21	15,0	389
25 G 1	6.445,53	250,0	32 x 0,21	17,5	533
34 G 1	8.184,89	340,0	32 x 0,21	20,4	721

Number of cores and nominal cross section mm ²	Price	Copper figure	Cond. construction (appr. value)	Overall diameter	Weight
	EUR / km	kg/km	mm	mm	appr. kg / km
2 X 1,5 *	833,63	30,0	30 x 0,26	7,6	90
3 G 1,5	1.019,37	45,0	30 x 0,26	8,2	110
4 G 1,5	1.326,67	60,0	30 x 0,26	9,1	138
5 G 1,5	1.759,95	75,0	30 x 0,26	10,1	172
7 G 1,5	2.657,20	105,0	30 x 0,26	11,1	219
12 G 1,5	3.938,85	180,0	30 x 0,26	14,9	388
18 G 1,5	5.659,95	270,0	30 x 0,26	17,9	565
25 G 1,5	9.075,15	375,0	30 x 0,26	20,9	775
34 G 1,5	9.706,97	510,0	30 x 0,26	24,3	1.051
3 G 2,5	1.679,34	75,0	50 x 0,26	9,7	162
4 G 2,5	2.136,58	100,0	50 x 0,26	10,7	205
5 G 2,5	2.566,47	125,0	50 x 0,26	12,0	256
7 G 2,5	3.949,09	175,0	50 x 0,26	13,2	328
12 G 2,5	5.572,71	300,0	50 x 0,26	17,8	581
18 G 2,5	8.663,05	450,0	50 x 0,26	21,3	848
34 G 2,5	15.370,92	850,0	50 x 0,26	29,0	1.584
4 G 4 *	3.550,82	160,0	56 x 0,31	11,6	280
5 G 4 *	4.305,36	200,0	56 x 0,31	14,1	340
7 G 4 *	5.314,04	280,0	56 x 0,31	15,1	445
4 G 6 *	5.052,09	240,0	84 x 0,31	16,8	450
5 G 6 *	5.572,71	300,0	84 x 0,31	18,4	550

* adapted to DIN VDE

H05VVC4V5-K PVC Control Cable with Copper Braiding, Oil Resistant

Application: Suitable for dry, damp and wet locations but not in the open-air. It is used as a screened termination and connection cable in the control, measuring and signal technology. Suitable as a signal and impulse cable for control and inspection of industrial plants, machinery and working processes.

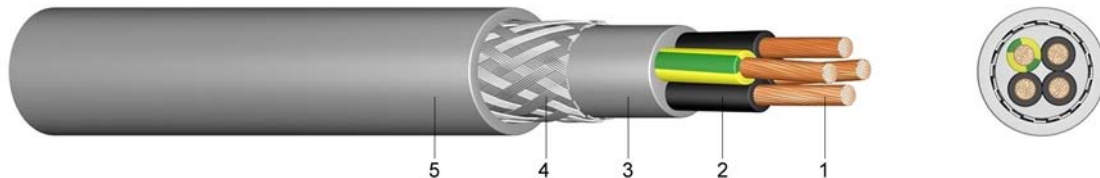

Construction:

- 1 fine-stranded bare copper
- 2 core insulation of polyvinylchloride (PVC-mixture YI2)
- 3 inner sheath of polyvinylchloride (mixture YM2)
- 4 braiding of tinned copper wires
- 5 outer sheath of polyvinylchloride (PVC-mixture YM2), grey

Standards: DIN VDE 0281-13
 HD 21.13.S1
 DIN EN 60228 class 5 (construction)
 core identification: 1 core green/yellow, other cores black with figures

Technical data:

Nominal voltage U ₀ /U		[V]	300 / 500 Volt
Test voltage at 50 Hz	core / core	[V] _{AC}	2000
	core / screen	[V] _{AC}	1000
Temperature range	in motion		-5°C till +70°C
	fixed		-40°C till +70°C
Operating temperature	short circuit	°C	150
Short circuit time	max.	[sec]	5
Bending radius	one time / fixed	x diameter	12,5
Bending radius	in motion	x diameter	15,0
Oil-resistant	standard		EN 60811-2-1
Flammability	standard		EN 60332-1-2

Number of cores and nominal cross section mm ²	Price EUR / km	Copper figure kg/km	Cond. construction (appr. value) mm	Overall diameter mm	Weight appr. kg / km
2 X 0,75 *	2.139,01	43	24 x 0,21	8,4	111
3 G 0,75	2.484,82	57	24 x 0,21	8,9	130
4 G 0,75	3.236,43	70	24 x 0,21	9,6	150
5 G 0,75	3.934,55	82	24 x 0,21	10,5	179
7 G 0,75	5.131,18	113	24 x 0,21	12,5	263
12 G 0,75	8.089,74	192	24 x 0,21	14,6	363

Number of cores and nominal cross section mm ²	Price	Copper figure	Cond. construction (appr. value)	Overall diameter	Weight
	EUR / km	kg/km	mm	mm	appr. kg / km
25 G 0,75	14.950,39	331	24 x 0,21	19,5	643
3 G 1	2.879,82	78	32 x 0,21	9,3	143
4 G 1	3.598,17	89	32 x 0,21	10,0	171
5 G 1	4.329,55	106	32 x 0,21	10,9	199
7 G 1	5.970,74	132	32 x 0,21	13,4	314
12 G 1	9.377,45	206	32 x 0,21	15,4	408
18 G 1	13.146,95	316	32 x 0,21	17,9	564
2 X 1,5 *	2.879,93	74	30 x 0,26	10,0	163
3 G 1,5	3.373,80	99	30 x 0,26	10,6	186
4 G 1,5	4.383,06	121	30 x 0,26	11,5	224
5 G 1,5	5.450,82	135	30 x 0,26	12,6	268
7 G 1,5	7.607,85	227	30 x 0,26	15,4	418
12 G 1,5	11.239,40	322	30 x 0,26	17,8	558
18 G 1,5	16.010,35	428	30 x 0,26	20,9	763
25 G 1,5	21.348,81	568	30 x 0,26	24,0	1.012
3 G 2,5	5.339,50	154	50 x 0,26	12,1	251
4 G 2,5	6.581,39	170	50 x 0,26	13,4	323
5 G 2,5	7.840,01	208	50 x 0,26	14,7	390
7 G 2,5	10.471,15	300	50 x 0,26	17,9	583
12 G 2,5	16.731,73	516	50 x 0,26	20,8	778
18 G 2,5	23.937,37	615	50 x 0,26	24,4	1.088

* adapted to DIN VDE

H05VV5-F UL/CSA

PVC Control Cable Oil Resistant with UL and CSA - Approbation (UL-Style 2587)

Application:

In dry and wet locations for low and medium-level mechanical stress, but not in the open-air. To be used as a termination and connection cable in the control, measuring and signal technology. Suitable as a signal and impulse cable for control and inspection of industrial plants, production lines and machinery.



Construction:

- 1 fine-stranded bare copper
- 2 core insulation of special-polyvinylchloride (PVC)
- 3 outer sheath of special polyvinylchloride (PVC), grey

Information:

- 0,50 mm² is equivalent to app. AWG 20 (0,519mm²)
- 0,75 mm² is equivalent to app. AWG 18 (0,823mm²)
- 1,00 mm² is equivalent to app. AWG 17 (1,040mm²)
- 1,50 mm² is equivalent to app. AWG 15 (1,650mm²)
- 2,50 mm² is equivalent to app. AWG 13 (2,630mm²)

Standards:

- DIN VDE 0281-13, HD 21.13.S1
- UL/CSA (UL-Style 2587)
- DIN EN 60228 class 5 (construction)
- core identification: 1 core green/yellow, other cores black with figures

Technical data:

Nominal voltage U ₀ /U		[V]	600 Volt
Test voltage		[V] _{Ac}	3000
Temperature range	in motion		-5°C till +90°C
	fixed		-40°C till +90°C
Operating temperature	short circuit	°C	150
Short circuit time	max.	[sec]	5
Bending radius	one time / fixed	x diameter	12,5
Bending radius	in motion	x diameter	15,0
Oil-resistant	standard		EN 60811-2-1
Flammability	standard		EN 60332-1-2
Insulation resistance	min.	[MΩm/km]	20

Number of cores and nominal cross section mm ²	Price EUR / km	Copper figure kg/km	Cond. construction (appr. value) mm	Overall diameter mm	Weight appr. kg / km
3 G 0,5	1.112,93	15,0	16 x 0,21	6,1	54
4 G 0,5	1.436,73	20,0	16 x 0,21	6,7	67
5 G 0,5	1.739,25	25,0	16 x 0,21	7,5	83
7 G 0,5	2.607,99	35,0	16 x 0,21	8,2	103
12 G 0,5	3.738,17	60,0	16 x 0,21	10,9	182

Number of cores and nominal cross section mm ²	Price	Copper figure	Cond. construction (appr. value)	Overall diameter	Weight
	EUR / km	kg/km	mm	mm	appr. kg / km
18 G 0,5	5.607,24	90,0	16 x 0,21	13,0	262
25 G 0,5	7.162,42	125,0	16 x 0,21	15,2	357
34 G 0,5	10.139,39	170,0	16 x 0,21	17,6	482
41 G 0,5	12.291,84	205,0	16 x 0,21	19,5	588
50 G 0,5	14.990,04	250,0	16 x 0,21	21,3	707
61 G 0,5	18.287,21	305,0	16 x 0,21	22,9	834
3 G 0,75	1.307,68	22,5	24 x 0,21	6,6	66
4 G 0,75	1.650,59	30,0	24 x 0,21	7,3	83
5 G 0,75	1.899,70	37,5	24 x 0,21	8,1	102
7 G 0,75	2.819,64	52,5	24 x 0,21	8,9	129
12 G 0,75	4.168,61	90,0	24 x 0,21	11,9	227
18 G 0,75	6.445,27	135,0	24 x 0,21	14,2	329
25 G 0,75	8.721,13	187,5	24 x 0,21	16,5	449
34 G 0,75	11.310,06	255,0	24 x 0,21	19,2	609
41 G 0,75	15.379,92	307,5	24 x 0,21	21,2	742
50 G 0,75	18.545,70	375,0	24 x 0,21	23,3	893
61 G 0,75	22.625,74	457,0	24 x 0,21	24,9	1.056
3 G 1	1.372,91	30,0	32 x 0,21	6,9	77
4 G 1	1.762,58	40,0	32 x 0,21	7,7	96
5 G 1	2.177,00	50,0	32 x 0,21	8,5	120
7 G 1	2.969,20	70,0	32 x 0,21	9,4	152
12 G 1	4.991,02	120,0	32 x 0,21	12,6	268
18 G 1	7.537,70	180,0	32 x 0,21	15,0	389
25 G 1	9.936,19	250,0	32 x 0,21	17,5	533
34 G 1	13.295,64	340,0	32 x 0,21	20,4	722
41 G 1	16.293,26	410,0	32 x 0,21	22,6	879
50 G 1	20.063,21	500,0	32 x 0,21	24,7	1.059
61 G 1	25.115,35	610,0	32 x 0,21	26,5	1.257
3 G 1,5	1.596,94	45,0	30 x 0,26	8,2	110
4 G 1,5	2.125,31	60,0	30 x 0,26	9,1	138
5 G 1,5	2.671,24	75,0	30 x 0,26	10,1	172
7 G 1,5	3.881,76	105,0	30 x 0,26	11,1	219
12 G 1,5	6.294,01	180,0	30 x 0,26	14,9	388
18 G 1,5	9.142,16	270,0	30 x 0,26	17,9	565
25 G 1,5	12.072,35	375,0	30 x 0,26	20,9	774
34 G 1,5	17.057,65	510,0	30 x 0,26	24,3	1.051
41 G 1,5	20.471,90	614,0	30 x 0,26	26,9	1.281
50 G 1,5	20.447,25	750,0	30 x 0,26	29,5	1.545
61 G 1,5	30.592,72	915,0	30 x 0,26	31,6	1.835
3 G 2,5	2.627,65	75,0	48 x 0,26	9,4	162
4 G 2,5	3.181,88	100,0	48 x 0,26	10,7	205
5 G 2,5	3.797,37	125,0	48 x 0,26	12,0	256
7 G 2,5	5.633,47	175,0	48 x 0,26	13,2	328
12 G 2,5	9.159,08	300,0	48 x 0,26	17,8	581
18 G 2,5	13.548,14	450,0	48 x 0,26	21,3	849
25 G 2,5	18.832,38	625,0	48 x 0,26	24,9	1.167
34 G 2,5	25.612,03	850,0	48 x 0,26	29,0	1.584
50 G 2,5	37.664,77	1.250,0	48 x 0,26	35,2	2.331

H05VVC4V5-K PVC Control Cable with Copper Braiding with UL and CSA Approbation (UL-Style 2587), Oil Resistant

Application:

Suitable for dry, damp and wet locations but not in the open-air. It is used as a screened termination and connection cable in the control, measuring and signal technology. The copper braiding optimises protection against external interferences, like electromagnetic fields and stray frequencies. Suitable as a signal and impulse cable for control and inspection of industrial plants, machinery and working processes.

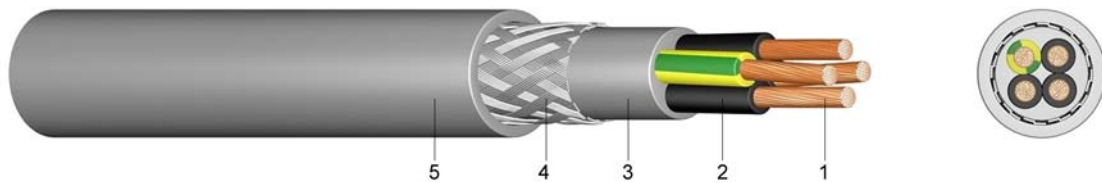

Construction:

- 1 fine-stranded bare copper
- 2 core insulation of special polyvinylchloride (PVC)
- 3 inner sheath of special polyvinylchloride (PVC)
- 4 braiding of tinned copper wires
- 5 outer sheath of special polyvinylchloride (PVC), grey

Information:

- 0,50 mm² is equivalent to app. AWG 20 (0,519mm²)
- 0,75 mm² is equivalent to app. AWG 18 (0,823mm²)
- 1,00 mm² is equivalent to app. AWG 17 (1,040mm²)
- 1,50 mm² is equivalent to app. AWG 15 (1,650mm²)
- 2,50 mm² is equivalent to app. AWG 13 (2,630mm²)

Standards:

- DIN VDE 0281-13, HD 21.13.S1
- UL/CSA (UL-Style 2587)
- DIN EN 60228 class 5 (construction)
- core identification: 1 core green/yellow, other cores black with figures

Technical data:

Nominal voltage U ₀ /U	[V]	600 Volt
Test voltage	[V] _{AC}	3000
Temperature range	in motion	-5°C till +90°C
	fixed	-40°C till +90°C
Operating temperature	short circuit	°C
Short circuit time	max.	[sec]
Bending radius	one time / fixed	x diameter
Bending radius	in motion	x diameter
Oil-resistant	standard	EN 60811-2-1
Flammability	standard	EN 60332-1-2
Insulation resistance	min.	[MΩm/km]
		20

Number of cores and nominal cross section mm ²	Price EUR / km	Copper figure kg/km	Cond. construction (appr. value) mm	Overall diameter mm	Weight appr. kg / km
3 G 0,75	3.373,38	53	24 x 0,21	8,8	125
4 G 0,75	3.928,29	66	24 x 0,21	9,6	147
5 G 0,75	4.448,26	82	24 x 0,21	10,3	172

Number of cores and nominal cross section mm ²	Price	Copper figure	Cond. construction (appr. value)	Overall diameter	Weight
	EUR / km	kg/km	mm	mm	appr. kg / km
7 G 0,75	5.169,76	112	24 x 0,21	12,2	235
12 G 0,75	6.957,75	168	24 x 0,21	14,5	354
18 G 0,75	10.436,61	229	24 x 0,21	16,9	478
3 G 1	3.767,16	78	32 x 0,21	9,3	140
4 G 1	4.378,77	90	32 x 0,21	9,9	165
5 G 1	4.895,60	106	32 x 0,21	10,9	195
7 G 1	6.629,18	132	32 x 0,21	12,9	271
12 G 1	8.941,50	202	32 x 0,21	15,4	405
18 G 1	13.412,25	276	32 x 0,21	17,7	548
3 G 1,5	4.542,53	99	30 x 0,26	10,4	180
4 G 1,5	4.985,52	121	30 x 0,26	11,3	217
5 G 1,5	5.479,25	135	30 x 0,26	12,6	267
7 G 1,5	6.929,32	175	30 x 0,26	14,9	379
12 G 1,5	9.662,48	265	30 x 0,26	17,6	538
18 G 1,5	14.493,73	400	30 x 0,26	20,5	743
3 G 2,5	5.130,01	154	50 x 0,26	12,0	246
4 G 2,5	6.236,25	170	50 x 0,26	13,3	316
5 G 2,5	8.151,90	208	50 x 0,26	14,6	383

YSLY PVC Control Cable for Intrinsically Safe Circuits with Blue Outer Sheath

Application: Suitable for dry, damp and wet locations as well as in areas with explosion hazard but not in the open-air. To be used as a connection and control cable for the application in intrinsically safe circuits for medium-level mechanical stress.



Construction:
 1 fine-stranded bare copper
 2 core insulation of polyvinylchloride (PVC)
 3 outer sheath of polyvinylchloride (PVC), blue, increased oil resistant

Information: **Capacity:** Core / Core approx. 120 nF/km
Inductivity: approx. 0,65 mH/km

Standards: adapted to DIN VDE 0281
 DIN EN 60228 class 5 (construction)
 core identification JZ: 1 core green/yellow, other cores black with figures
 core identification OZ: every core black with figures

Technical data:

Nominal voltage U ₀ /U	[V]	300 / 500 Volt
Test voltage	[V] _{Ac}	2000
Temperature range	in motion	- 5°C till +70°C
	fixed	-30°C till +70°C
Operating temperature	short circuit	150
Short circuit time	max.	[sec] 5
Bending radius	one time / fixed	x diameter 6
Bending radius	in motion	x diameter 15
Flammability	standard	EN 60332-1-2

Number of cores and nominal cross section mm ²	Price		Copper figure kg/km	Cond. construction (appr. value) mm	Overall diameter appr. mm	Weight appr. kg / km
	EUR / km J	EUR / km O				
2 x 0,75		515,27	15,0	24 x 0,21	5,3	42
3 x 0,75		704,29	22,5	24 x 0,21	5,5	50
4 x 0,75		944,59	30,0	24 x 0,21	6,2	64
5 x 0,75	1.068,00		37,5	24 x 0,21	6,7	77
7 x 0,75		1.579,78	52,5	24 x 0,21	7,4	99
25 x 0,75	4.935,20	5.429,18	187,5	24 x 0,21	13,9	333
2 x 1		636,70	20,0	32 x 0,21	5,5	50
7 x 1		1.808,91	70,0	32 x 0,21	8,0	114
18 x 1	4.244,29		180,0	32 x 0,21	12,7	303
2 x 1,5		747,55	30,0	30 x 0,26	6,3	63
3 x 1,5	922,72	1.014,85	45,0	30 x 0,26	6,6	79
4 x 1,5	1.183,60	1.302,02	60,0	30 x 0,26	7,3	98
5 x 1,5	1.547,79		75,0	30 x 0,26	8,1	123
7 x 1,5	2.071,55		105,0	30 x 0,26	8,9	161
12 x 1,5	3.598,75		180,0	30 x 0,26	11,8	277

YSLCY PVC Control Cable for Intrinsically Safe Circuits with Copper Braiding and Blue Outer Sheath

Application: For dry, humid and wet locations as well as areas with explosion hazard, but not in the open-air. To be used as an MSR cable for the application in intrinsically safe circuits. The copper braiding optimises protection against external electrical and magnetic interferences. The cable is suitable for medium-level mechanical stress.

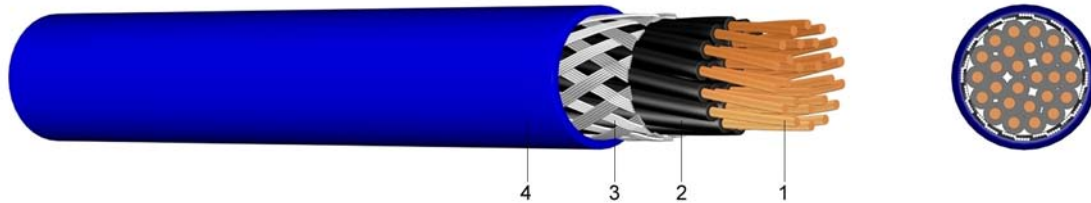

Construction:

- 1 fine-stranded bare copper
- 2 core insulation of polyvinylchloride (PVC)
- 3 braiding of tinned copper wires
- 4 outer sheath of polyvinylchloride (PVC), blue, increased oil resistant

Information:

Capacity:
core / core : appr. 150 nF/km and core / screen : app. 200 nF/km
Inductivity: approx. 0,65 mH/km

Standards:

adapted to DIN VDE 0281
DIN EN 60228 class 5 (construction)
core identification JZ: 1 core green/yellow, other cores black with figures
core identification OZ: every core black with figures

Technical data:

Nominal voltage U ₀ /U		[V]	300 / 500 Volt
Test voltage		[V] _{Ac}	2000
Temperature range	in motion		-5°C till +70°C
	fixed		-30°C till +70°C
Operating temperature	short circuit	°C	150
Short circuit time	max.	[sec]	5
Bending radius	one time / fixed	x diameter	10
Bending radius	in motion	x diameter	20
Flammability	standard		EN 60332-1-2

Number of cores and nominal cross section mm ²	Price EUR / km		Copper figure kg/km	Cond. construction (appr. value) mm	Overall diameter appr. mm	Weight appr. kg / km
	J	O				
2 x 0,75		1.661,09	43	24 x 0,21	6,2	56
3 x 0,75		1.996,07	52	24 x 0,21	6,5	70
4 x 0,75	2.173,21	2.252,99	61	24 x 0,21	7,0	96
5 x 0,75		2.531,11	72	24 x 0,21	7,8	157
7 x 0,75		3.215,14	89	24 x 0,21	8,4	168
12 x 0,75		5.100,12	138	24 x 0,21	10,9	231
18 x 0,75		6.853,21	211	24 x 0,21	12,8	314
25 x 0,75		8.913,24	280	24 x 0,21	15,2	434
2 x 1,5		2.108,89	65	30 x 0,26	7,1	97
3 x 1,5	2.477,25	2.561,81	82	30 x 0,26	7,6	124
4 x 1,5	2.920,18	3.029,40	100	30 x 0,26	8,2	166
5 x 1,5		3.503,37	119	30 x 0,26	9,0	192
7 x 1,5		4.430,98	154	30 x 0,26	9,8	245

SLM 0,6/1 kV PVC Composite Connection Cable

Application: These connection cables are well suited for fixed installations and for flexible use e.g. in machine and plant engineering for medium level mechanical stress in dry, damp and wet locations.

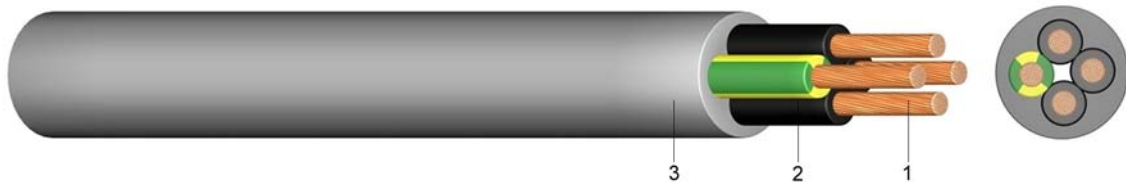

Construction:

- 1 fine-stranded bare copper
- 2 core insulation of polyvinylchloride (PVC)
- 3 outer sheath of polyvinylchloride (PVC)
grey or black, increased oil resistant

Standards: DIN EN 60228 class 5 (construction)
HD 308 S2 (core identification)
core identification: 1 core green/yellow, other cores black with figures

Technical data:

Nominal voltage U ₀ /U		[V]	600 / 1000 Volt
Test voltage		[V] _{ac}	4000
Temperature range	in motion fixed		-5°C till +70°C -30°C till +70°C
Bending radius	one time / fixed	x diameter	5,0
Bending radius	in motion	x diameter	7,5
Flammability	standard		EN 60332-1-2

Number of cores and nominal cross section mm ²	Price EUR / km	Copper figure kg/km	Cond. construction (appr. value) mm	Overall diameter mm	Weight appr. kg / km
4 x 1,5	2.254,05	60	30 x 0,26	10,7	176
4 x 2,5	3.043,23	100	48 x 0,26	10,7	242
4 x 4	4.220,45	160	56 x 0,31	13,7	330
4 x 6	5.964,57	240	84 x 0,31	15,0	428
4 x 10	9.606,01	400	80 x 0,41	18,3	668
4 x 16	13.776,43	640	128 x 0,41	20,7	941
4 x 25	21.333,00	1.000	200 x 0,41	25,2	1.431
5 x 4	5.176,78	200	56 x 0,31	14,9	400
5 x 6	7.075,48	300	84 x 0,31	16,4	523
5 x 10	10.647,95	500	80 x 0,41	20,2	820

SLCM 0,6/1 kV PVC Composite Connection Cable with Copper Braiding

Application:

These connection cables are well suited for fixed installations and for flexible use e.g. in machine and plant engineering for medium-level mechanical stress in dry, damp and wet locations. With the copper braiding electrical and magnetic interferences exerted on other cables and wires or adjacent electric components are effectively suppressed. They are especially suitable as supply cables between frequency converters and servomotors.

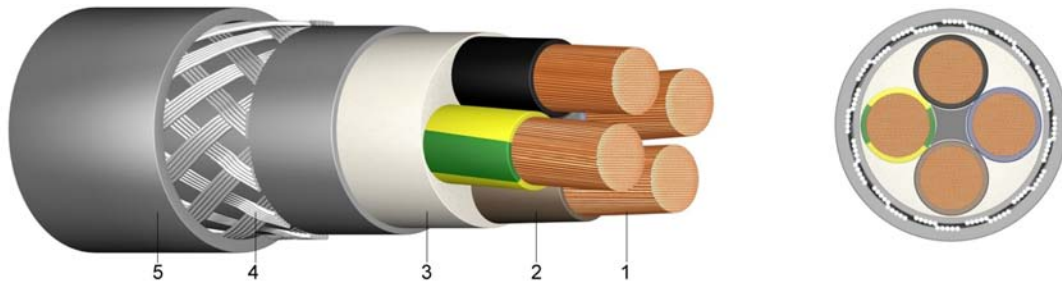

Construction:

- 1 fine-stranded bare copper
- 2 core insulation of polyvinylchloride (PVC)
- 3 inner sheath of polyvinylchloride (PVC)
- 4 screen of tinned copper braiding
- 5 outer sheath of polyvinylchloride (PVC), grey, increased oil resistant

Standards:

adapted to DIN EN 60228 class 5 (construction)
 HD 308 S2 (core identification)
 core identification: 1 core green/yellow, other cores black with figures

Technical data:

Nominal voltage U_0/U		[V]	600 / 1000 Volt
Test voltage at 50 Hz	core / core	[V] _{AC}	4000
	core / screen	[V] _{AC}	4000
Temperature range	in motion		+5°C till +70°C
	fixed		-30°C till +70°C
Bending radius	one time / fixed	x diameter	7,5
Bending radius	in motion	x diameter	15,0
Flammability	standard		EN 60332-1-2

Number of core and nominal cross section mm ²	Price	Copper figure	Cond. construction (appr. value) mm	Overall diameter mm	Weight
	EUR / km	kg/km			appr. kg / km
4 x 1,5	4.704,42	101	30 x 0,26	12,7	240
4 x 2,5	5.290,08	158	48 x 0,26	14,5	335
4 x 4	8.070,43	258	56 x 0,31	16,1	440
4 x 6	9.348,49	345	84 x 0,31	17,4	553
4 x 10	12.614,22	554	80 x 0,41	20,9	830
4 x 16	18.290,10	821	128 x 0,41	23,3	1.136
4 x 25	29.169,98	1.285	200 x 0,41	28,2	1.696
4 x 35	36.481,70	1.752	280 x 0,41	31,4	2.204
4 x 50 *	48.457,13	2.475	400 x 0,41	36,8	3.074
4 x 70 *	66.090,87	3.324	350 x 0,51	42,3	4.169
4 x 95 *	91.241,39	4.489	485 x 0,51	47,0	5.600

* with coloured cores according to HD 308 S2

2YSLCY

PVC Composite Connection Cable with Copper Braiding, EMV Standardised

Application:

These composite connection cables are produced according to the European EMV Guidelines and are particularly suitable for plants and facilities with appliances and electrical equipment of which electromagnetic interference fields could have an undue influence on the surroundings. These connection cables are well suited for fixed installations and for flexible use in motive power engineering with frequency converting technology (e.g. machine and plant engineering) for medium-level mechanical loads in dry, humid and wet locations.

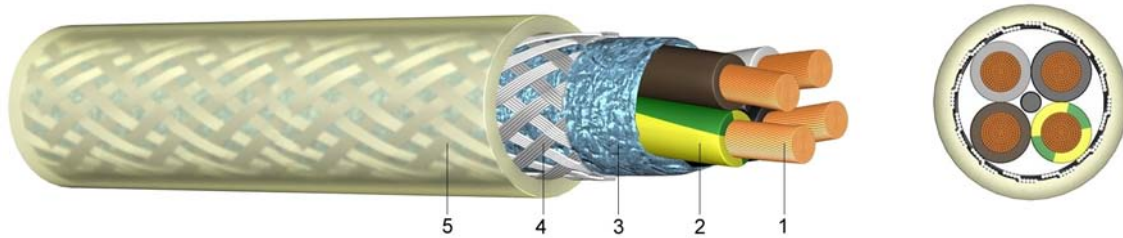

Construction:

- 1 fine-stranded bare copper
- 2 core insulation of polyethylene (PE)
- 3 layer of foil
- 4 static screen of aluminium foil
- 5 concentric screen of tinned copper wires
- 6 outer sheath of polyvinylchloride (PVC), transparent

Standards:

- DIN VDE 0281
 DIN EN 60228 class 5 (construction)
 HD 308 S2 (core identification)
 DIN VDE 0207
 EN 55011

Technical data:

Nominal voltage U_0/U		[V]	600 / 1000 Volt
Test voltage at 50 Hz	core / core	[V] _{AC}	4000
	core / screen	[V] _{AC}	4000
Temperature range	in motion		- 5°C till +70°C
	fixed		-30°C till +70°C
Operating temperature	short circuit	°C	160
Short circuit time	max.	[sec]	5
Bending radius	one time / fixed	x diameter	7,5
Bending radius	in motion	x diameter	15,0
Flammability	standard		EN 60332-1-2

Number of cores and nominal cross section mm ²	Price EUR / km	Copper figure kg/km	Wire diameter mm	Overall diameter mm	Weight appr. kg / km
4 x 1,5	5.494,00	94	0,26	11,4	170
4 x 2,5	5.777,95	156	0,26	13,0	235
4 x 4	8.737,27	224	0,31	14,7	320
4 x 6	10.266,21	302	0,31	16,7	425
4 x 10	14.921,03	490	0,41	20,9	665
4 x 16	21.509,19	740	0,41	23,7	970
4 x 25	33.385,06	1.063	0,41	28,3	1.400

Number of cores and nominal cross section mm²	Price EUR / km	Copper figure kg/km	Wire diameter mm	Overall diameter mm	Weight appr. kg / km
4 x 35	41.466,12	1.563	0,41	32,1	1.890
4 x 50	54.614,58	2.188	0,41	38,7	2.700
4 x 70	74.651,33	3.329	0,51	43,2	3.480
4 x 120	112.970,90	5.320	0,51	53,4	5.660
4 x 150	140.973,43	6.650	0,51	59,6	6.930

2YSLCYK

PVC Composite Connection Cable with Copper Braiding, EMV Standardised

Application:

These composite connection cables are produced according to the European EMV Guidelines and are particularly suitable for plants and facilities with appliances and electrical equipment of which electromagnetic interference fields could have an undue influence on the surroundings. These connection cables are well suited for fixed installations and for flexible use in motive power engineering with frequency converting technology (e.g. machine and plant engineering) for medium-level mechanical loads in dry, humid and wet locations and outdoor.

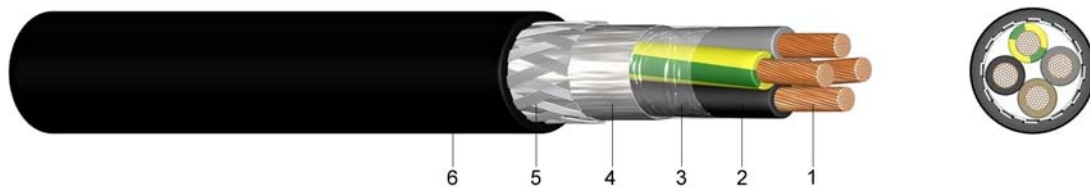

Construction:

- 1 fine-stranded bare copper
- 2 core insulation of polyethylene (PE)
- 3 layer of foil
- 4 screen of PETP aluminium foil
- 5 concentric screen of tinned copper wires
- 6 outer sheath of polyvinylchloride (PVC) which is flexible black

Standards:

DIN VDE 0281
 DIN EN 60228 class 5 (construction)
 HD 308 S2 (core identification)
 DIN VDE 0207
 EN 55011

Technical data:

Nominal voltage U ₀ /U		[V]	600 / 1000 Volt
Test voltage at 50 Hz	core / core	[V] _{AC}	4000
	core / screen	[V] _{AC}	4000
Temperature range	in motion		-5°C till +70°C
	fixed		-40°C till +70°C
Operating temperature	short circuit	°C	160
Short circuit time	max.	[sec]	5
Bending radius	one time / fixed	x diameter	7,5
Bending radius	in motion	x diameter	15,0
Flammability	standard		EN 60332-1-2

Number of cores and nominal cross section mm ²	Price EUR / km	Copper figure kg/km	Cond. construction (appr. value) mm	Overall diameter mm	Weight appr. kg / km
4 x 1,5	5.494,00	99	30 x 0,26	11,4	170
4 x 2,5	5.777,95	156	48 x 0,26	13,0	235
4 x 4	8.737,27	244	56 x 0,31	14,7	320
4 x 6	10.266,21	333	84 x 0,31	16,7	425
4 x 10	14.921,03	554	80 x 0,41	20,9	665
4 x 16	21.509,19	821	128 x 0,41	23,7	970

Number of cores and nominal cross section mm ²	Price	Copper figure	Cond. construction (appr. value)	Overall diameter	Weight
	EUR / km	kg/km	mm	mm	appr. kg / km
4 x 25	33.385,06	1.285	200 x 0,41	28,3	1.400
4 x 35	41.466,12	1.730	280 x 0,41	32,1	1.890
4 x 50	54.614,58	2.439	400 x 0,41	38,7	2.700
4 x 70	74.651,33	3.324	350 x 0,51	43,2	3.480
4 x 95	98.677,56	4.489	485 x 0,51	49,3	4.570
4 x 120	112.970,90	5.320	614 x 0,51	53,4	5.660
4 x 150	140.973,43	6.660	765 x 0,51	59,6	6.930
4 x 185	163.977,96	8.531	944 x 0,51	64,1	8.330

YSL11Y

PUR Control Cable

Application:

Used as energy or connecting cable, as measuring, checking and control cable in machine tool manufacturing, plant engineering and on assembly lines and production lines to meet stringent safety requirements. Suitable for fixed installation or flexible applications with unrestricted mobility without forced movement control and without exposure to tensile load. Installation in dry and moist rooms.



Construction:

- 1 fine-stranded bare copper
- 2 core insulation of polyvinylchloride (PVC)
- 3 outer sheath of polyurethane (PUR), grey, oil resistant

Standards:

adapted to DIN VDE 0281
 DIN EN 60228 class 5 (construction)
 core identification JZ: 1 core green/yellow, other cores black with figures
 core identification OZ: every core black with figures

Technical data:

Nominal voltage U ₀ /U		[V]	300 / 500 Volt
Test voltage		[V] _{Ac}	3000
Temperature range	in motion fixed		- 5°C till +70°C -40°C till +70°C
Bending radius	one time / fixed	x diameter	6
Bending radius	in motion	x diameter	20
Flammability	standard		EN 60332-1-2

Number of cores and nominal cross section mm ²	Price		Copper figure kg/km	Cond. construction (appr. value) mm	Overall diameter appr. mm	Weight appr. kg / km
	EUR / km J	EUR / km O				
2 x 0,75		1.854,69	15,0	24 x 0,21	5,4	43
3 x 0,75	2.137,43		22,5	24 x 0,21	5,7	61
4 x 0,75	2.389,58		30,0	24 x 0,21	6,2	75
5 x 0,75	2.787,31		37,5	24 x 0,21	6,7	100
7 x 0,75	3.208,26		52,5	24 x 0,21	7,3	125
2 x 1		2.201,79	20,0	32 x 0,21	5,7	57
3 x 1	2.382,19		30,0	32 x 0,21	6,0	80
4 x 1	2.703,97		40,0	32 x 0,21	6,5	106
5 x 1	3.294,77		50,0	32 x 0,21	7,1	123
7 x 1	3.739,98		70,0	32 x 0,21	8,0	149
2 x 1,5		2.497,19	30,0	30 x 0,26	6,3	100
3 x 1,5	2.587,92		45,0	30 x 0,26	6,7	110
4 x 1,5	3.183,99		60,0	30 x 0,26	7,2	125
5 x 1,5	3.948,87		75,0	30 x 0,26	8,1	145
7 x 1,5	4.953,23		105,0	30 x 0,26	8,9	195
3 x 2,5	4.338,16		75,0	48 x 0,26	8,1	170
4 x 2,5	5.117,81		100,0	48 x 0,26	8,9	180
5 x 2,5	6.630,68		125,0	48 x 0,26	10,0	190
7 x 2,5	6.995,71		175,0	48 x 0,26	11,1	280

S 80

PVC Cable Chain Cable

Application:

The flexible cable chain cable S 80 is best suited for application in moving machine parts, industrial robots, production lines, wood and packaging machines, machine tools, cable chains and automation systems.

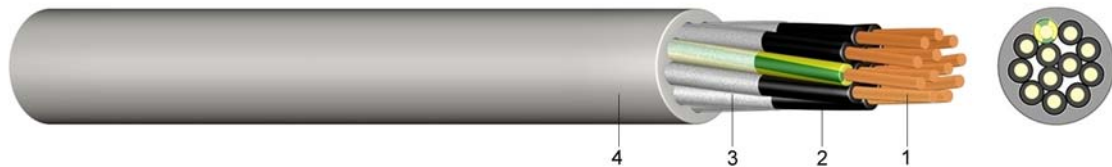

Construction:

- 1 fine-stranded bare copper
- 2 core insulation of polyvinylchloride (PVC)
- 3 fine cotton binding over the outside
- 4 outer sheath of polyvinylchloride (PVC), grey or black

Standards:

in according with DIN VDE 0281
 DIN EN 60228 class 6 (construction)
 core identification JZ: 1 core green/yellow, other cores black with figures
 core identification OZ: every core black with figures

Technical data:

Nominal voltage U_0/U		[V]	300 / 500 Volt
Test voltage		[V] _{AC}	2000
Temperature range	in motion		- 5°C till +70°C
	fixed		-40°C till +70°C
Operating temperature	short circuit	°C	150
Short circuit time	max.	[sec]	5
Bending radius	one time / fixed	x diameter	5,0
Bending radius	in motion	x diameter	7,5
Flammability	standard		EN 60332-1-2

Number of cores and nominal cross section mm ²	Price	Price	Copper figure kg/km	Wire diameter mm	Overall diameter appr. mm	Weight appr. kg / km
	EUR / km J	EUR / km O				
3 x 0,5	1.723,53		15,0	0,16	6,7	52
7 x 0,5	2.988,92		35,0	0,16	9,9	118
12 x 0,5	4.199,86		60,0	0,16	9,9	145
18 x 0,5	5.757,65		90,0	0,16	14,0	250
25 x 0,5	8.416,23		125,0	0,16	16,4	350
2 x 0,75		1.426,71	15,0	0,16	6,7	48
3 x 0,75	1.450,55		22,5	0,16	7,1	61
4 x 0,75	1.906,04		30,0	0,16	7,7	76
5 x 0,75	2.004,09		37,5	0,16	8,9	102
7 x 0,75	3.399,27		52,5	0,16	10,8	152
12 x 0,75	4.883,20		90,0	0,16	12,9	214
18 x 0,75	6.922,53		135,0	0,16	14,8	306
25 x 0,75	9.793,51		187,5	0,16	18,1	454
2 x 1		1.549,89	20,0	0,16	7,1	55
3 x 1	1.617,35		30,0	0,16	7,5	71
4 x 1	2.122,39		40,0	0,16	8,7	97
5 x 1	2.280,80		50,0	0,16	9,4	119
7 x 1	3.912,45		70,0	0,16	11,4	177

Number of cores and nominal cross section mm ²	Price	Price	Copper figure kg/km	Wire diameter mm	Overall diameter appr. mm	Weight appr. kg / km
	EUR / km J	EUR / km O				
12 x 1	5.704,62		120	0,16	13,6	253
18 x 1	8.191,17		180	0,16	16,4	387
25 x 1	11.514,13		250	0,16	19,1	535
2 x 1,5		1.927,78	30	0,16	8,7	78
3 x 1,5	2.013,74		45	0,16	9,1	101
4 x 1,5	2.503,30		60	0,16	9,9	126
5 x 1,5	2.908,90		75	0,16	11,1	166
7 x 1,5	5.208,88		105	0,16	13,1	234
12 x 1,5	8.588,26		180	0,16	16,5	357
18 x 1,5	11.568,22		270	0,16	19,6	540
25 x 1,5	15.244,20		375	0,16	22,6	708
3 x 2,5	4.674,07		75	0,16	11,0	160
4 x 2,5	5.736,49		100	0,16	12,0	201
5 x 2,5	6.982,20		125	0,16	13,0	250
7 x 2,5	10.109,29		175	0,16	15,6	355
12 x 2,5	15.849,03		300	0,16	19,9	573
25 x 2,5	30.457,92		625	0,16	28,5	1.134
4 x 4	10.029,39		160	0,16	13,6	262
5 x 4	11.710,47		200	0,16	14,8	328
7 x 4	15.986,16		280	0,16	17,4	458
4 x 6	10.914,78		240	0,21	15,3	359
5 x 6	12.850,34		300	0,21	17,6	476
7 x 6	17.591,29		420	0,21	24,6	666
4 x 10	20.814,35		400	0,21	20,6	639
4 x 16	28.306,71		640	0,21	23,8	910

S 80 C

PVC Cable Chain with Copper Braiding

Application:

The flexible cable chain cable S 80 C is best suited for the application in moving machine parts, industrial robots, wood and packaging machines, production lines, machine tools, cable chains and automation systems. The tinned copper braiding optimises protection against high-frequency external interference.

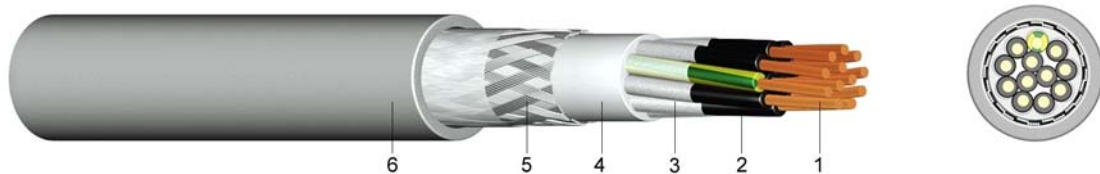

Construction:

- 1 fine-stranded bare copper
- 2 core insulation of polyvinylchloride (PVC)
- 3 cotton binding
- 4 inner sheath
- 5 screen of tinned copper braiding
- 6 outer sheath of polyvinylchloride (PVC), grey or black

Standards:

in according with DIN VDE 0281
 DIN EN 60228 class 6 (construction)
 core identification JZ: 1 core green/yellow, other cores black with figures
 core identification OZ: every core black with figures

Technical data:

Nominal voltage U ₀ /U		[V]	300 / 500 Volt
Test voltage at 50 Hz	core / core	[V] _{AC}	2500
	core / screen	[V] _{AC}	1000
Temperature range	in motion		- 5°C till +70°C
	fixed		-40°C till +70°C
Operating temperature	short circuit	°C	150
Short circuit time	max.	[sec]	5
Bending radius	one time / fixed	x diameter	5,0
Bending radius	in motion	x diameter	7,5
Flammability	standard		EN 60332-1-2

Number of cores and nominal cross section mm ²	Price	Price	Copper figure kg/km	Wire diameter mm	Overall diameter appr. mm	Weight appr. kg / km
	EUR / km J	EUR / km O				
3 x 0,5	3.376,13		58	0,16	8,8	113
4 x 0,5	3.744,26		69	0,16	9,5	132
5 x 0,5	4.138,45		78	0,16	10,2	154
12 x 0,5	6.804,01		132	0,16	14,3	302
18 x 0,5	8.882,88		199	0,16	17,2	429
2 x 0,75		3.139,19	58	0,16	8,8	113
3 x 0,75	3.241,55		67	0,16	9,4	132
4 x 0,75	3.627,48		83	0,16	9,9	153
5 x 0,75	4.180,08		96	0,16	11,0	184
7 x 0,75	5.149,56		114	0,16	12,5	241
25 x 0,75	13.020,63		333	0,16	21,9	688

Number of cores and nominal cross section mm ²	Price	Price	Copper figure kg/km	Wire diameter mm	Overall diameter appr. mm	Weight appr. kg / km
	EUR / km J	EUR / km O				
2 x 1		3.296,22	63	0,16	9,1	126
3 x 1	3.441,03		74	0,16	9,7	149
5 x 1	4.367,00		108	0,16	11,5	209
7 x 1	5.687,75		141	0,16	12,4	250
12 x 1	7.900,96		228	0,16	17,5	305
18 x 1	10.889,30		316	0,16	19,5	593
25 x 1	14.506,78		398	0,16	23,4	815
2 x 1,5		3.854,64	82	0,16	10,7	170
3 x 1,5	4.069,70		98	0,16	11,2	196
4 x 1,5	4.783,52		124	0,16	12,0	223
5 x 1,5	5.558,17		136	0,16	13,0	268
7 x 1,5	7.696,14		178	0,16	15,7	390
12 x 1,5	11.343,28		313	0,16	19,5	580
18 x 1,5	14.411,16		411	0,16	22,8	780
25 x 1,5	19.045,92		556	0,16	27,3	1.109
3 x 2,5	7.040,47		137	0,16	12,7	264
4 x 2,5	8.361,56		172	0,16	14,0	337
7 x 2,5	14.556,44		310	0,16	19,3	592

S 200

PUR Cable Chain Cable

Application:

This highly flexible cable chain cable S 200 is best suited for application in industrial branches such as industrial robots, handling gears, automation systems, wood and packaging machines, automobile industry, machine tools and high shelf building.

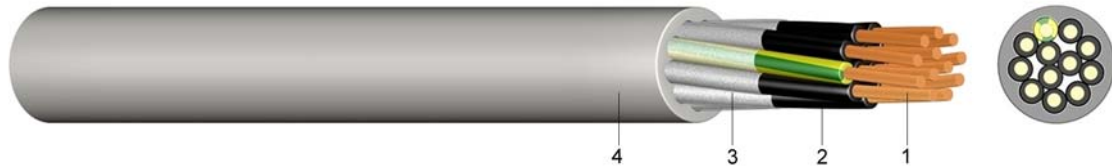

Construction:

- 1 very fine-stranded bare copper
- 2 core insulation of thermoplastic polyester elastomer (TPE-E) or polypropylene (PP)
- 3 fine cotton binding over each layer
- 4 outer sheath of polyurethane (PUR), grey, poor in adhesion, oil and abrasion resistant, halogen-free

Standards:

in according with DIN VDE 0281
 DIN EN 60228 class 6 (construction)
 core identification JZ: 1 core green/yellow, other cores black with figures
 core identification OZ: every core black with figures

Technical data:

Nominal voltage U ₀ /U	[V]	300 / 500 Volt
Test voltage	[V]AC	2500
Temperature range	in motion	-30°C till +70°C
	fixed	-40°C till +70°C
Operating temperature	short circuit	150
Short circuit time	max.	[sec] 5
Bending radius	one time / fixed	x diameter 5,0
Bending radius	in motion	x diameter 7,5
Oil-resistant	standard	EN 60811-2-1
Flammability	standard	EN 60332-1-2

Number of cores and nominal cross section mm ²	Price	Price	Copper figure kg/km	Wire diameter mm	Overall diameter appr. mm	Weight appr. kg / km
	EUR / km J	EUR / km O				
2 x 0,5		3.682,85	10,0	0,16	5,7	37
5 x 0,5	5.013,24		25,0	0,16	7,2	58
7 x 0,5	6.208,02		35,0	0,16	8,2	76
12 x 0,5	9.288,24		60,0	0,16	9,6	117
25 x 0,5	18.561,59		125,0	0,16	14,0	223
36 x 0,5	23.972,50		180,0	0,16	20,1	321
2 x 0,75		3.470,70	15,0	0,16	6,2	44
3 x 0,75	3.614,68		22,5	0,16	6,5	54
4 x 0,75	4.098,66		30,0	0,16	7,3	63
5 x 0,75	4.651,97		37,5	0,16	7,9	74
7 x 0,75	5.959,68		52,5	0,16	9,3	102
12 x 0,75	9.200,31		90,0	0,16	10,9	161
18 x 0,75	12.627,02		135,0	0,16	12,9	222
25 x 0,75	17.709,94		187,5	0,16	18,1	454
36 x 0,75	27.480,29		270,0	0,16	26,0	653

Number of cores and nominal cross section mm ²	Price	Price	Copper figure kg/km	Wire diameter mm	Overall diameter appr. mm	Weight appr. kg / km
	EUR / km J	EUR / km O				
3 x 1	4.022,13		30,0	0,16	7,2	64
4 x 1	4.647,55		40,0	0,16	7,7	73
5 x 1	5.290,88		50,0	0,16	8,3	95
7 x 1	6.878,92		70,0	0,16	10,1	122
12 x 1	10.599,10		120,0	0,16	11,8	201
18 x 1	14.776,15		180,0	0,16	14,4	277
25 x 1	20.519,96		250,0	0,16	16,0	312
30 x 1	28.021,26		300,0	0,16	19,2	374
36 x 1	32.327,54		360,0	0,16	23,0	449
2 x 1,5		4.819,11	30,0	0,16	7,2	71
3 x 1,5	4.941,01		45,0	0,16	7,7	86
4 x 1,5	5.687,75		60,0	0,16	8,6	104
5 x 1,5	6.795,75		75,0	0,16	9,4	132
7 x 1,5	9.796,30		105,0	0,16	11,4	181
12 x 1,5	14.566,79		180,0	0,16	13,3	279
18 x 1,5	19.862,66		270,0	0,16	15,9	408
25 x 1,5	27.490,29		375,0	0,16	19,3	569
34 x 1,5	36.331,79		510,0	0,16	26,2	773
3 x 2,5	8.952,33		75,0	0,16	9,5	124
4 x 2,5	10.543,37		100,0	0,16	10,4	164
5 x 2,5	13.628,37		125,0	0,16	11,6	199
7 x 2,5	18.159,73		175,0	0,16	14,0	269
12 x 2,5	28.781,03		300,0	0,16	16,6	448
4 x 4	15.092,41		160,0	0,16	13,6	262
4 x 6	17.186,41		240,0	0,21	15,3	359

S 200 C

PUR Cable Chain Cable with Copper Braiding

Application:

This highly flexible cable chain cable S 200 C is best suited for application in industrial robots, handling gears, automation systems, wood and packaging machines, the automobile industry, machine tools and high shelf building.

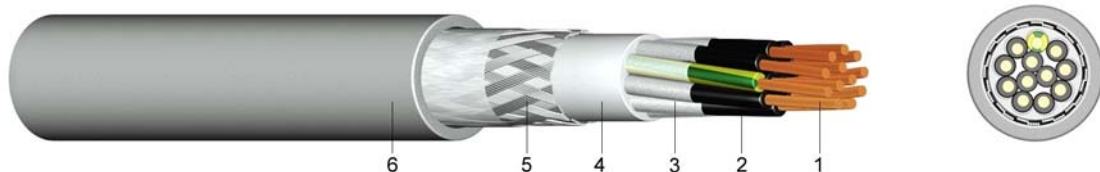

Construction:

- 1 very fine-stranded bare copper
- 2 core insulation of thermoplastic polyester elastomer (TPE-E) or polypropylene (PP)
- 3 wrapping of fine cotton binding
- 4 inner sheath
- 5 screen of tinned copper braiding
- 6 outer sheath of polyurethane (PUR), grey, poor in adhesion, oil and abrasion resistant, halogen-free

Standards:

in according with DIN VDE 0281
 DIN EN 60228 class 6 (construction)
 core identification JZ: 1 core green/yellow, other cores black with figures
 core identification OZ: every core black with figures

Technical data:

Nominal voltage U ₀ /U		[V]	300 / 500 Volt
Test voltage at 50 Hz	core / core	[V] _{AC}	2500
	core / screen	[V] _{AC}	1000
Temperature range	in motion		-30°C till +70°C
	fixed		-40°C till +70°C
Operating temperature	short circuit	°C	150
Short circuit time	max.	[sec]	5
Bending radius	one time / fixed	x diameter	5,0
Bending radius	in motion	x diameter	7,5
Oil-resistant	standard		EN 60811-2-1
Flammability	standard		EN 60332-1-2

Number of cores and nominal cross section mm ²	Price EUR / km J	Price EUR / km O	Copper figure kg/km	Wire diameter mm	Overall diameter appr. mm	Weight appr. kg / km
2 x 0,5		6.871,58	49	0,16	7,1	68
3 x 0,5	7.596,34		55	0,16	7,4	81
4 x 0,5	8.385,18		62	0,16	8,5	90
5 x 0,5	8.979,55		68	0,16	8,9	106
7 x 0,5	11.085,52		88	0,16	10,0	134
12 x 0,5	15.748,19		121	0,16	11,9	192
18 x 0,5	19.380,09		163	0,16	13,6	250
25 x 0,5	26.735,07		237	0,16	16,8	371

Number of cores and nominal cross section mm ²	Price EUR / km J	Price EUR / km O	Copper figure kg/km	Wire diameter mm	Overall diameter appr. mm	Weight appr. kg / km
2 x 0,75		7.177,72	55	0,16	7,7	79
3 x 0,75	7.197,15		65	0,16	8,1	96
4 x 0,75	7.404,42		73	0,16	8,7	114
5 x 0,75	8.592,10		90	0,16	9,5	125
7 x 0,75	10.776,70		111	0,16	11,3	167
12 x 0,75	15.370,86		162	0,16	12,9	235
18 x 0,75	19.824,64		243	0,16	15,5	336
25 x 0,75	27.382,82		326	0,16	18,4	466
36 x 0,75	43.751,07		416	0,16	22,1	636
3 x 1	7.738,48		73	0,16	8,7	105
4 x 1	8.597,33		92	0,16	9,3	128
5 x 1	9.922,15		103	0,16	10,1	147
7 x 1	11.938,34		130	0,16	12,0	198
12 x 1	17.520,69		194	0,16	13,9	301
18 x 1	22.863,92		291	0,16	16,8	420
25 x 1	32.053,51		393	0,16	20,2	576
41 x 1	39.688,38		623	0,16	25,4	1.250
50 x 1	48.400,48		754	0,16	23,4	1.212
2 x 1,5		8.922,20	82	0,16	8,8	116
3 x 1,5	8.978,26		98	0,16	9,4	139
4 x 1,5	10.570,36		117	0,16	10,2	157
5 x 1,5	11.816,90		134	0,16	11,3	198
7 x 1,5	16.039,20		177	0,16	12,9	252
12 x 1,5	22.589,29		290	0,16	15,6	419
18 x 1,5	29.894,03		410	0,16	18,7	561
25 x 1,5	41.767,46		555	0,16	22,4	815
36 x 1,5	65.997,81		732	0,16	27,3	1.047
3 x 2,5	16.026,53		135	0,16	11,2	197
4 x 2,5	19.053,35		171	0,16	12,1	233
5 x 2,5	21.265,18		198	0,16	13,3	290
7 x 2,5	27.239,52		285	0,16	16,2	417
12 x 2,5	39.105,84		443	0,16	18,9	631
18 x 2,5	53.570,62		633	0,16	22,5	918,
4 x 4	22.079,84		266	0,16	13,9	310
4 x 6	25.156,11		374	0,21	16,1	446

S 368 C

PUR Cable Chain Data Cable with Copper Braiding

Application:

This highly flexible cable chain data cable S 368 C is best suited for different industrial areas such as machine construction, the automobile and communications industry as well as for steering, controlling and measuring machinery. It is particularly suited for machinery put to prolonged, flexible use, such as industrial scales. The copper braiding should be fully connected to optimise protection against high-frequency external interference (EMC).

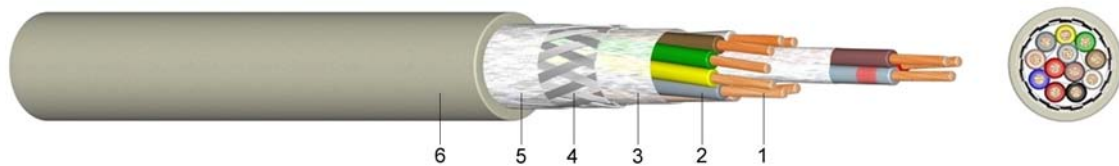

Construction:

- 1 very fine-stranded bare copper
- 2 core insulation of thermoplastic polyester elastomer (TPE-E) or polypropylene (PP)
- 3 wrapping of fine cotton binding
- 4 screen of tinned copper braiding
- 5 wrapping of fine cotton binding
- 6 outer sheath of polyurethane (PUR), grey, poor in adhesion, oil and abrasion resistant

Standards:

in according with DIN VDE 0281 and 0812
 DIN EN 60228 class 6 (construction)
 in according with DIN 47100 or factory style (core identification)

Technical data:

Ceiling voltage	[V]	till 0,34mm ²	250 Volt
	[V]	from 0,50mm ²	350 Volt
Test voltage		[V] _{Ac}	1500
Temperature range	in motion		-30°C till +80°C
Bending radius	min.	x diameter	7,5
Oil-resistant	standard		EN 60811-2-1
Flammability	standard		EN 60332-1-2

Number of cores and nominal cross section mm ²	Price	Copper figure	Wire diameter	Overall diameter	Weight
	EUR / km	kg/km	mm	appr. mm	appr. kg / km
2 x 0,14	3.385,90	12	0,10	3,9	30
4 x 0,14	3.938,39	16	0,10	4,3	38
7 x 0,14	5.685,31	27	0,10	5,1	58
12 x 0,14	7.855,13	44	0,10	5,9	92
2 x 0,25	3.717,39	17	0,10	4,2	35
3 x 0,25	3.976,19	20	0,10	4,4	40
4 x 0,25	4.322,22	22	0,10	4,6	46
5 x 0,25	4.831,68	32	0,10	4,9	61
7 x 0,25	6.449,95	39	0,10	5,6	77

Number of cores and nominal cross section mm ²	Price	Copper figure	Wire diameter	Overall diameter	Weight
	EUR / km	kg/km	mm	appr. mm	appr. kg / km
12 x 0,25	8.844,03	56	0,10	6,6	118
18 x 0,25	11.112,85	79	0,10	7,5	157
4 x 0,34	4.548,11	36	0,10	4,9	78
5 x 0,34	5.066,28	40	0,10	5,2	84
7 x 0,34	6.929,17	53	0,10	5,9	108
12 x 0,34	9.499,93	78	0,10	7,0	162
18 x 0,34	12.202,13	101	0,10	8,0	222
24 x 0,34	15.880,90	154	0,10	9,4	318
25 x 0,34	16.542,60	161	0,10	9,5	321
2 x 0,5	4.271,63	35	0,16	5,0	65
5 x 0,5	5.541,19	63	0,16	6,0	112
12 x 0,5	9.686,97	103	0,16	8,2	187
30 x 0,5	18.757,88	243	0,16	15,8	413
7 x 0,75	8.202,45	93	0,16	7,9	171

S 369 C TP

PUR Cable Chain Data Cable with Copper Braiding

Application:

This highly flexible pair wise stranded cable chain data cable is best suited for different industrial areas such as machine construction, the automobile and communications industry, as well as for steering, controlling and measuring machinery. It is particularly useful for machinery that is put to prolonged use, such as machine controls. The paired cable suppresses electrical couplings of individual signals whilst effectively lowering near- and crosstalk attenuation. The copper braiding should be fully connected to optimise protection against high frequency external interference (EMC).

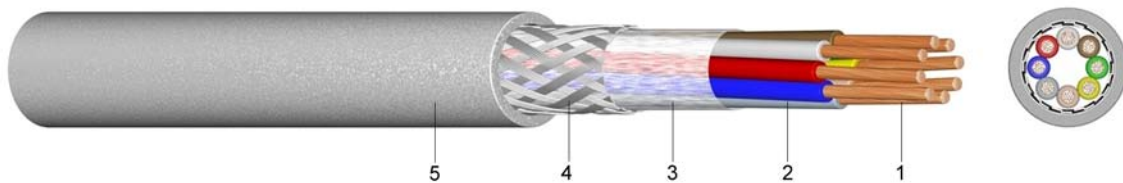

Construction:

- 1 very fine-stranded bare copper
- 2 core insulation of thermoplastic polyester elastom (TPE-E) or polypropylene (PP)
- 3 wrapping of fine cotton binding
- 4 screen of tinned copper braiding
- 5 outer sheath of polyurethane (PUR), grey, poor in adhesion, oil and abrasion resistant

Standards:

in according with DIN VDE 0812
 DIN EN 60228 class 6 (construction)
 in according with DIN 47100 or factory style (core identification)

Technical data:

Ceiling voltage	[V]	till 0,34mm ²	250 Volt 350 Volt 1500
Test voltage	[V]	from 0,50mm ²	
Temperature range	in motion	[V] _{Ac}	-30°C till +80°C
Bending radius	min.	x diameter	
Oil-resistant	standard		7,5
Flammability	standard		EN 60811-2-1 EN 60332-1-2

Number of cores and nominal cross section mm ²	Price EUR / km	Copper figure kg/km	Wire diameter mm	Overall diameter appr. mm	Weight appr. kg / km
2 x 2 x 0,14	5.246,34	17	0,10	6,1	42
3 x 2 x 0,14	6.155,32	21	0,10	6,4	54
4 x 2 x 0,14	7.167,26	28	0,10	6,9	59
5 x 2 x 0,14	8.292,00	38	0,10	7,4	75
6 x 2 x 0,14	9.192,74	51	0,10	7,6	91
8 x 2 x 0,14	12.136,30	57	0,10	8,7	109
10 x 2 x 0,14	13.975,91	63	0,10	10,1	120

Number of cores and nominal cross section mm ²	Price	Copper figure	Wire diameter	Overall diameter	Weight
	EUR / km	kg/km	mm	appr. mm	appr. kg / km
2 x 2 x 0,25	5.637,61	33	0,10	7,1	62
3 x 2 x 0,25	6.701,42	40	0,10	7,4	68
4 x 2 x 0,25	8.195,12	46	0,10	8,4	97
5 x 2 x 0,25	9.547,62	53	0,10	9,0	105
6 x 2 x 0,25	10.354,95	75	0,10	9,8	133
8 x 2 x 0,25	14.443,96	77	0,10	11,5	153
10 x 2 x 0,25	20.360,85	95	0,10	12,8	191
14 x 2 x 0,25	23.885,73	114	0,10	13,4	214
2 x 2 x 0,34	6.089,49	27	0,10	6,1	50
3 x 2 x 0,34	7.177,84	35	0,10	6,4	54
4 x 2 x 0,34	8.588,26	45	0,10	7,0	66
5 x 2 x 0,34	10.099,64	56	0,10	7,5	77
6 x 2 x 0,34	11.216,25	63	0,10	8,4	99
8 x 2 x 0,34	16.370,12	88	0,10	9,4	122
10 x 2 x 0,34	21.215,63	98	0,10	10,5	146
2 x 2 x 0,5	6.390,40	53	0,16	9,3	102
3 x 2 x 0,5	7.339,40	75	0,16	10,0	127
4 x 2 x 0,5	8.845,43	77	0,16	11,1	152
5 x 2 x 0,5	12.270,76	88	0,16	11,9	171
6 x 2 x 0,5	12.822,20	105	0,16	12,8	195
8 x 2 x 0,5	17.831,37	149	0,16	15,7	251
10 x 2 x 0,5	21.446,51	182	0,16	17,6	348
2 x 2 x 0,75	7.380,46	63	0,16	9,7	113
3 x 2 x 0,75	8.959,88	90	0,16	10,9	161
4 x 2 x 0,75	11.470,52	105	0,16	11,5	170
5 x 2 x 0,75	13.370,38	119	0,16	12,5	205
6 x 2 x 0,75	14.731,03	139	0,16	13,4	229
8 x 2 x 0,75	22.417,38	199	0,16	16,4	345
10 x 2 x 0,75	25.282,42	267	0,16	19,3	459
12 x 2 x 0,75	29.115,66	286	0,16	16,4	351

SL 800

Combined Composite Connection Cable with PUR Outer Sheath

Application:

This cable is well suited for flexible use in industries such as industrial robots, cable chains or machine and plant engineering. It is used for high mechanical stress in dry, damp and wet locations as well as at low temperatures as a connection cable for the power supply and as a signal and data cable for the steering and control of motors.

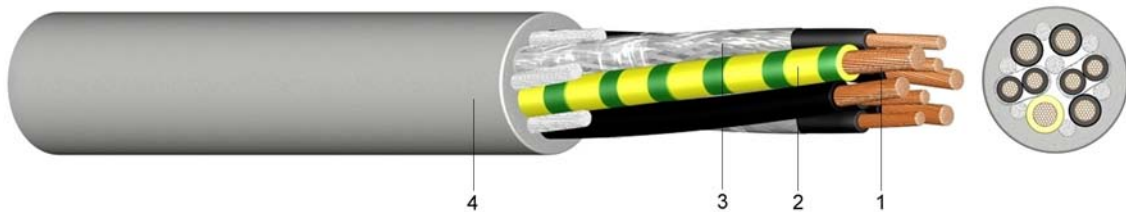

Construction:

- 1 very fine-stranded bare copper
- 2 core insulation of thermoplastic polyester elastomer or polypropylene (PP)
- 3 pair wise shielding of aluminium foil
- 4 outer sheath of polyurethane (PUR), grey, oil and abrasion resistant

Standards:

in according with DIN VDE 0281
DIN EN 60228 class 6 (construction)

Technical data:

Nominal voltage U ₀ /U		[V]	600 / 1000 Volt
Test voltage		[V] _{Ac}	4000
Temperature range	in motion		-30°C till +80°C
Operating temperature	short circuit	°C	150
Short circuit time	max.	[sec]	5
Bending radius	min.	x diameter	7,5
Oil-resistant	standard		EN 60811-2-1
Flammability	standard		EN 60332-1-2

Number of cores and nominal cross section mm ²	Price EUR / km	Copper figure kg/km	Wire diameter mm	Overall diameter appr. mm	Weight appr. kg / km
4 x 0,75 + 2x(2x0,34)	15.177,55	68	0,16	9,7	125
4 x 1,50 + 2x(2x0,75)	18.548,09	126	0,16	11,4	350
4 x 2,50 + 2x(2x0,75)	22.175,11	166	0,16	13,7	244
4 x 4,00 + (2x0,75)+(2x1)	25.585,07	229	0,16	15,6	352
4 x 6,00 + (2x0,75)+(2x1)	28.803,83	312	0,21	18,3	473
4 x 10,00 + (2x0,75)+(2x1)	41.696,62	472	0,21	22,1	685
4 x 16,00 + 2x(2x1)	53.308,81	716	0,21	25,2	993
4 x 25,00 + 2x(2x1,5)	67.801,15	1.076	0,21	30,0	1.740
4 x 35,00 + 2x(2x1,5)	86.271,19	1.500	0,21	32,2	2.410

SL 801 C

Combined Composite Connection Cable with PUR Outer Sheath and Copper Braiding

Application:

This cable is well suited for flexible use in industries such as industrial robots, cable chains or machine and plant engineering. It is used for high mechanical stress in dry, damp and wet locations as well as at low temperatures as a connection cable for the power supply and as a signal and data cable for the steering and control of motors.

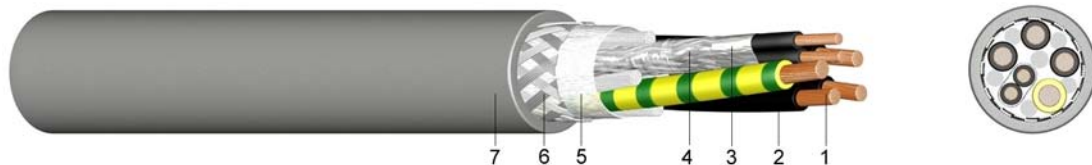

Construction:

- 1 very fine-stranded bare copper
- 2 core insulation of polypropylene (PP)
- 3 pair wise shielding of aluminium foil
- 4 pair wise shielding of copper braiding
- 5 wrapping of fine cotton binding
- 6 screen of tinned copper braiding
- 7 outer sheath of polyurethane (PUR), grey, oil and abrasion resistant

Standards:

in according with DIN VDE 0281
DIN EN 60228 class 6 (construction)

Technical data:

Nominal voltage U ₀ /U		[V]	600 / 1000 Volt
Test voltage		[V] _{AC}	4000
Temperature range	in motion		-30°C till +80°C
Operating temperature	short circuit	°C	150
Short circuit time	max.	[sec]	5
Bending radius	min.	x diameter	7,5
Oil-resistant	standard		EN 60811-2-1
Flammability	standard		EN 60332-1-2

Number of cores and nominal cross section mm ²	Price EUR / km	Copper figure kg/km	Wire diameter mm	Overall diameter appr. mm	Weight appr. kg / km
4 x 0,75 + 2 x (2x0,34)	15.135,10	126	0,16/0,11	11,0	171
4 x 1,50 + 2 x (2x0,75)	20.423,53	194	0,16/0,11	12,1	370
4 x 2,50 + 2 x (2x0,75)	24.411,58	235	0,16/0,11	15,3	312
4 x 4,00 + 2 x (2x1)	29.463,67	344	0,21/0,16	17,3	445
4 x 6,00 + 2 x (2x1)	33.390,31	451	0,21/0,16	19,3	589
4 x 10,00 + 2 x (2x1)	48.882,14	624	0,21/0,16	23,4	804
4 x 16,00 + 2 x (2x1)	61.550,92	904	0,21/0,16	27,0	1.134
4 x 25,00 + 2 x (2x1,5)	80.280,91	1.307	0,21/0,16	29,2	1.782
4 x 35,00 + 2 x (2x1,5)	123.876,0	1.748	0,21/0,16	32,4	2.570

SL 803 C

Incremental Transmission Cable with PUR Outer Sheath

Application:

These cables are used as highly flexible connection cables in speedometers, brakes and pulse generators in machine and plant engineering. Moreover, they are well suited for flexible use in industrial robots and cable chains for extreme mechanical stress, also in dry, damp and wet locations as well as at low temperatures. These two types show different characteristics in relation to the steering of servo-motors. The motor feedback cable is used to regulate motor speed and indicate actual values. The incremental transmission cable controls positioning and processing.



Construction:

- 1 very fine-stranded bare copper
- 2 core insulation of polypropylene (PP)
- 3 banding of plastic-concealed Al-foil and braided shield
- 4 screen of tinned copper braiding
- 5 outer sheath of polyurethane (PUR), grey, oil and abrasion resistant

Standards:

in according with DIN VDE 0281
 DIN EN 60228 class 6 (construction)
 in according with DIN 47100 (core identification)

Technical data:

Nominal voltage U_0/U		[V]	250 Volt
Test voltage		[V] _{AC}	2000
Temperature range	in motion		-30°C till +80°C
Operating temperature	short circuit	°C	150
Short circuit time	max.	[sec]	5
Bending radius	min.	x diameter	7,5
Oil-resistant	standard		EN 60811-2-1
Flammability	standard		EN 60332-1-2

Number of cores and nominal cross section mm ²	Price	Copper figure	Wire diameter	Overall diameter	Weight
	EUR / km	kg/km	mm	appr. mm	appr. kg / km
4 x 2 x 0,25 + 2x1	11.811,43	75	0,16/0,11	8,8	134
4 x 2 x 0,14 + 4x0,5	12.160,49	58	0,16/0,11	8,2	109
4 x 2 x 0,38 + 4x0,5	13.260,82	82	0,16/0,11	8,6	203
10 x 0,14 + 2 x 0,5	10.553,14	48	0,16/0,11	8,0	70
10 x 0,14 + 4 x 0,5	12.258,31	60	0,16/0,11	8,0	85
15 x 0,14 + 4x0,5	13.710,37	68	0,16/0,11	8,8	127
3 x (2 x 0,14C)+2x1	12.623,30	84	0,16/0,11	8,4	108
3 x 2 x 0,14C+2x(0,5C)	13.904,85	91	0,16/0,11	8,3	100

SL 805

Combined Composite Connection Cable with PVC Outer Sheath

Application:

This cable is well suited for flexible use in machine and plant engineering. It is used for medium level mechanical stress in dry, damp and wet locations. It serves as a connection cable for the power supply and as a signal and data cable for the steering and control of motors.

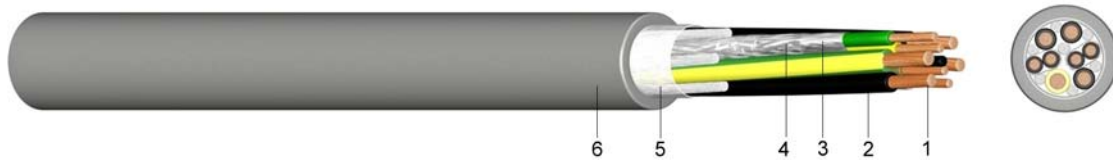

Construction:

- 1 fine-stranded bare copper
- 2 core insulation of polyvinylchloride (PVC)
- 3 pair wise shielding of aluminium foil
- 4 pair wise shielding of tinned copper braiding
- 5 wrapping of fine cotton
- 6 outer sheath of polyvinylchloride (PVC)

Standards:

in according with DIN VDE 0281
DIN VDE 0295 class 5 (construction)

Technical data:

Nominal voltage U ₀ /U		[V]	600 / 1000 Volt
Test voltage		[V] _{Ac}	4000
Temperature range	in motion		- 5°C till +70°C
	fixed		-30°C till +80°C
Operating temperature	short circuit	°C	150
Short circuit time	max.	[sec]	5
Bending radius	min.	x diameter	7,5
Flammability	standard		EN 60332-1-2

Number of cores and nominal cross section mm ²	Price EUR / km	Copper figure kg/km	Wire diameter mm	Overall diameter appr. mm	Weight appr. kg / km
4 x 0,75 + 2x(2x0,34)	8.833,92	72	0,16	10,6	126
4 x 1,50 + 2x(2x0,75)	11.596,01	126	0,16	12,7	194
4 x 2,50 + 2x(2x0,75)	12.769,97	166	0,16	14,9	318
4 x 4,00 + (2x0,75)+(2x1)	14.738,93	233	0,16	16,6	414
4 x 6,00 + (2x0,75)+(2x1)	17.771,93	312	0,21	18,7	551
4 x 10,00 + (2x0,75)+(2x1)	25.341,98	472	0,21	22,4	822
4 x 16,00 + 2x(2x1)	33.898,71	717	0,21	25,9	1.127
4 x 25,00 + 2x(2x1)	47.650,37	1.104	0,21	29,5	1.632
4 x 35,00 + 2x(2x1,5)	70.419,37	1.504	0,21	33,2	2.058

SL 806 C

Combined Composite Connection Cable with PVC Outer Sheath

Application:

This cable is well suited for flexible use in machine and plant engineering. It is used for medium level mechanical stress in dry, damp and wet locations. It serves as a connection cable for the power supply and as a signal and data cable for the steering and control of motors.

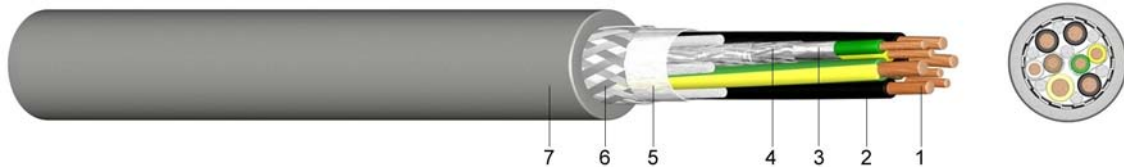

Construction:

- 1 very fine-stranded bare copper
- 2 core insulation of polyvinylchloride (PVC)
- 3 pair wise screened with aluminium foil
- 4 paarweise screened with tinned copper drain wire
- 5 wrapping of fine cotton binding
- 6 screen of tinned copper braiding
- 7 outer sheath of polyvinylchloride (PVC)

Standards:

in according with DIN VDE 0281
DIN EN 60228 class 6 (construction)

Technical data:

Nominal voltage U ₀ /U	Powerwire	[V]	600 / 1000 Volt
	Controllwire	[V]	300 / 500 Volt
Test voltage	Powerwire	[V] _{AC}	4000
	Controllwire	[V] _{AC}	2000
Temperature range	in motion		+5°C till +70°C
Operating temperature	short circuit	°C	150
Short circuit time	max.	[sec]	5
Bending radius	min.	x diameter	7,5
Flammability	standard		EN 60332-1-2

Number of cores and nominal cross section mm ²	Price EUR / km	Copper figure kg/km	Wire diameter mm	Overall diameter appr. mm	Weight appr. kg / km
4 x 0,75 + 2 x (2x0,34)	11.181,60	131	0,16	11,5	171
4 x 1,50 + 2 x (2x0,75)	13.647,09	187	0,16	13,8	256
4 x 2,50 + 2 x (2x0,75)	15.186,75	240	0,16	16,2	394
4 x 10,00 + 2 x (2x1)	22.859,03	625	0,21	23,5	854
4 x 16,00 + 2 x (2x1)	40.303,76	902	0,21	26,5	1.152
4 x 25,00 + 2 x (2x1,5)	56.229,91	1.310	0,21	30,0	1.672
4 x 35,00 + 2 x (2x1,5)	90.846,16	1.748	0,21	34,2	2.116

SL 808C

Incremental Transmission Cable with PVC Outer Sheath

Application:

These cables are used as highly flexible connection cables in speedometers, brakes and pulse generators in machine and plant engineering for medium-level mechanical stress in dry, damp and wet locations. These two types show different characteristics in relation to the steering of servomotors. The motor feedback cable is used to regulate motor speed and indicate actual values. The incremental transmission cable controls positioning and processing.

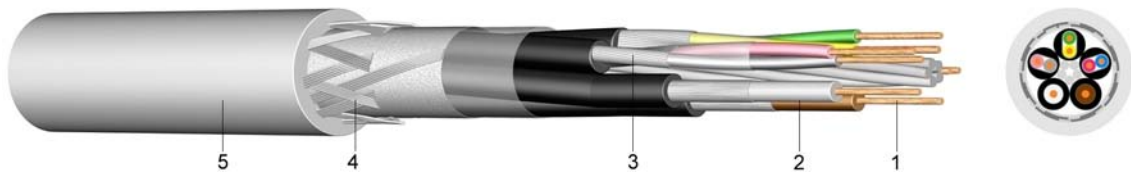

Construction:

- 1 fine-stranded bare copper
- 2 core insulation of polyethylene (PE)
- 3 banding of plastic-concealed Al-foil and braided shield
- 4 screen of tinned copper braiding
- 5 outer sheath of polyvinylchloride (PVC)

Standards:

in according with DIN 0281, 0812
 DIN EN 60228 class 5 (construction)
 in according with DIN 47100 (core identification)

Technical data:

Nominal voltage U ₀ /U	[V]	till 0,38mm ²	350 Volt
	[V]	from 0,50 mm ²	500 Volt
Test voltage	[V] _{AC}		2000
Temperature range	in motion		- 5°C till +70°C
	fixed		-30°C till +80°C
Operating temperature	short circuit	°C	150
Short circuit time	max.	[sec]	5
Bending radius	min.	x diameter	7,5
Flammability	standard		EN 60332-1-2

Number of cores and nominal cross section mm ²	Price	Copper figure	Wire diameter	Overall diameter	Weight
	EUR / km	kg/km	mm	appr. mm	appr. kg / km
4 x 2 x 0,14 + 4x0,5	7.124,81	72	0,16/0,21	8,0	96
4 x 2 x 0,25 + 2x1C	7.169,12	67	0,16/0,21	9,0	120
4 x 2 x 0,38 + 4x0,5	8.359,70	82	0,16/0,21	9,9	145
10 x 0,14 + 2x0,5	5.996,21	46	0,11/0,21	8,0	75
10 x 0,14 + 4x0,5	6.697,47	60	0,11/0,21	8,2	95
15 x 0,14 + 4x0,5	7.409,42	70	0,11/0,21	8,8	140
3 x (2x x 0,14C)+2x(0,5C)	12.384,04	86	0,11/0,21	8,0	100

H07G-K (110°) Rubber Insulated Single Core Wire with Increased Heat-Resistance

Application: This wire is well suited for internal wiring in lamps, instruments, control panels and distributors in dry locations. It should be installed in surface mounted or embedded conduits.



Construction: 1 fine-stranded tinned or bare copper
2 core insulation of a heat resistant rubber compound

Standards: DIN VDE 0282 Part 7
HD 22.7 S2:1995 + A1 :1999+A2:2004
DIN EN 60228 Class 5 (construction)

Technical data:

Nominal voltage U ₀ /U		[V]	450 / 750 Volt
Test voltage		[V] _{Ac}	2500
Temperature range	in motion		-25°C till +110°C
Operating temperature	short circuit	°C	260
Short circuit time	max.	[sec]	5
Bending radius	min.	x diameter	7
Flammability	standard		EN 60332-1-2

Nominal cross section	Colours	Price	Copper figure	Cond. construction (appr. value)	Overall diameter	Weight
mm ²		EUR / km	kg/km	mm	mm	appr. kg / km
1,5	bk	571,80	15	30 x 0,26	3,4	25
2,5	bk	839,32	25	50 x 0,26	4,0	40
4	bk	1.432,29	40	56 x 0,31	5,0	60
6	bk	1.532,44	60	84 x 0,31	5,5	80
10	bk	2.518,42	100	80 x 0,41	7,0	125
16	bk	3.698,90	160	126 x 0,41	8,0	190
25	bk	6.629,07	250	196 x 0,41	10,0	292
35	bk	8.498,82	350	276 x 0,41	11,5	420

SiA Silicone Insulated Wire

Application: This wire is well suited for internal wiring in lamps, instruments, control panels and distributors for low mechanical stress particularly at high ambient temperatures.



Construction: 1 solid bare copper
2 core insulation of silicone (2G11)

Standards: DIN EN 60228 Class 1 (construction)

Technical data:

Nominal voltage U ₀ /U		[V]	300 / 500 Volt
Test voltage		[V] _{AC}	2000
Temperature range	in motion temporary resilient		-60°C till +180°C +250°C
Flammability	standard		EN 60332-1-2

Nominal cross section	Colours	Price	Copper figure	Cond. construction (appr. value)	Overall diameter	Weight
mm ²		EUR / km	kg/km	mm	mm	appr. kg / km
0,75	bk/bl/br/yg/gr/wt/rd	274,19	7,5	1 x 0,98	2,2	12
1	bk/bl/br/yg/wt	311,05	10,0	1 x 1,13	2,3	15
1,5	bk/bl/br/yg/wt/rd	399,63	15,0	1 x 1,38	2,6	20
2,5	bk/bl/yg	589,38	25,0	1 x 1,78	3,2	33
4	bk	787,10	40,0	1 x 2,26	3,9	51
6	bk	1.497,41	60,0	1 x 2,76	4,4	72
10	bk	2.147,73	100,0	1 x 3,57	5,6	120

SiF Silicone Insulated Wire

Application: This wire is well suited for internal wiring in lamps, instruments, control panels and distributors for low mechanical stress particularly at high ambient temperatures.

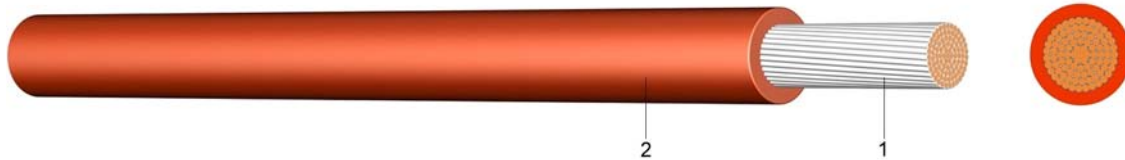

Construction: 1 fine-stranded tinned or bare copper
2 core insulation of silicone (2GI1)

Standards: DIN EN 60228 Class 5 (construction)

Technical data:

Nominal voltage U ₀ /U	[V]	300 / 500 Volt
Test voltage	[V] _{AC}	2000
Temperature range	in motion	-60°C till +180°C
	temporary resilient	+250°C
Flammability	standard	EN 60332-1-2

Nominal cross section mm ²	Colours	Price	Copper figure	Cond. construction (appr. value) mm	Overall diameter mm	Weight appr. kg/km
		EUR / km	kg/km			
0,50	bk/bl/br/yg/gr/wt/rd	315,66	5,0	16 x 0,21	2,1	10
0,75	bk/bl/br/yg/wt/rd	373,58	7,5	24 x 0,21	2,4	13
1	bk/bl/br/yg/gr/ws/rd/rbr	414,10	10,0	32 x 0,21	2,5	16
1,5	bk/bl/br/gg/yg/gr/wt/rd/rbr	485,02	15,0	30 x 0,26	2,8	22
2,5	bk/bl/br/yg/gr/wt/rd	691,51	25,0	50 x 0,26	3,4	35
4	bk/bl/br/yg/gr/wt/rd	1.002,82	40,0	56 x 0,31	4,2	54
6	bk/bl/br/yg/wt/rd	1.398,98	60,0	84 x 0,31	5,2	82
10	bk/bl/yg/rd	2.187,54	100,0	80 x 0,41	6,4	132
16	bk/bl/br/yg/rd/rbr	3.275,61	160,0	128 x 0,41	8,0	209
25	bk/bl/yg/rbr	5.036,59	250,0	200 x 0,41	10,0	327
35	bk/yg/rbr	6.596,18	350,0	280 x 0,41	11,2	439
50	bk/rbr	9.324,15	500,0	400 x 0,41	13,3	624
70	bk/rbr	12.946,36	700,0	356 x 0,51	15,4	860
95	bk/rbr	16.297,38	950,0	485 x 0,51	17,8	1.161
120	rbr	21.569,51	1.200,0	614 x 0,51	19,8	1.456
150	rbr	28.042,61	1.500,0	765 x 0,51	21,5	1.785
185	rbr	34.067,73	1.850,0	944 x 0,51	24,4	2.233
240	bk	45.053,79	2.400,0	1225 x 0,51	26,8	2.827

SiF/ GL**Silicone Insulated Wire
with Fibreglass Braiding****Application:**

This wire is well suited for internal wiring in lamps, instruments, control panels and distributors. It is used for high mechanical stress, as the fibreglass braiding protects the silicone insulation from mechanical damages. It is halogen-free and heat resistant.

**Construction:**

- 1 fine-stranded tinned or bare copper
- 2 core insulation silicon (2G11)
- 3 impregnated fibreglass braiding

Standards:

DIN EN 60228 Class 5 (construction)

Technical data:

Nominal voltage U_0/U

[V]

Test voltage

[V]_{AC}

Temperature range

in motion
temporary resilient
standard

300 / 500 Volt
2000
-60°C till +180°C
+250°C
EN 60332-1-2

Nominal cross section	Colours	Price	Copper figure	Cond. construction (appr. value)	Overall diameter	Weight
mm ²		EUR / km	kg/km	mm	mm	appr. kg / km
0,75	ws	690,36	7,5	24 x 0,21	2,7	15
1	ws	768,51	10,0	32 x 0,21	2,8	18
1,5	ws	856,24	15,0	30 x 0,26	3,3	26
2,5	ws	1.117,54	25,0	50 x 0,26	3,9	38
4	ws	1.543,02	40,0	56 x 0,31	4,5	55
6	ws	2.033,47	60,0	84 x 0,31	5,2	76
10	ws	3.305,04	100,0	80 x 0,41	7,3	136
16	ws	4.734,76	160,0	128 x 0,41	8,3	200
25	ws	6.870,55	250,0	200 x 0,41	10,2	311
35	ws	8.855,05	350,0	280 x 0,41	11,4	412
50	ws	11.849,14	500,0	400 x 0,41	14,1	583
70	ws	16.121,00	700,0	356 x 0,51	16,1	798
95	ws	19.547,15	950,0	495 x 0,51	18,5	1.073
120	ws	27.921,11	1.200,0	614 x 0,51	20,0	1.329

SiHF

Silicone Sheathed Cable

Application:

In dry, humid and wet locations as well as in the open-air for low mechanical stress, particularly at high ambient temperatures.

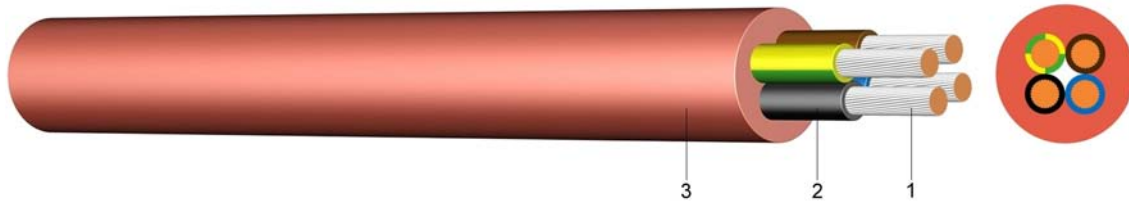

Construction:

- 1 fine-stranded tinned or bare copper
- 2 core insulation of silicone (2G11)
- 3 outer sheath of silicone (2GM1), reddish brown

Standards:

DIN VDE 0207 part 20
 DIN EN 60228 class 5 (construction)
 HD 308 S2 (core identification)

Technical data:

Nominal voltage U ₀ /U	[V]	300 / 500 Volt
Test voltage	[V] _{AC}	2000
Temperature range	in motion temporary resilient standard	-60°C till 180°C +250°C
Flammability		EN 60332-1-2

Number of cores and nominal cross section mm ²	Price EUR / km	Copper figure kg/km	Cond. construction (appr. value) mm	Overall diameter appr. mm	Weight appr. kg / km
2 x 0,75	1.795,12	15,0	24 x 0,21	6,4	63
3 x 0,75	1.992,67	22,5	24 x 0,21	6,8	76
4 x 0,75	2.619,84	30,0	24 x 0,21	7,8	101
5 x 0,75	3.062,54	37,5	24 x 0,21	8,5	120
7 x 0,75	3.703,83	52,5	24 x 0,21	9,2	148
2 x 1	1.926,77	20,0	32 x 0,21	6,6	71
3 x 1	2.408,67	30,0	32 x 0,21	7,4	93
4 x 1	2.825,60	40,0	32 x 0,21	8,1	113
5 x 1	3.362,12	50,0	32 x 0,21	8,8	136
7 x 1	4.129,50	70,0	32 x 0,21	9,5	169
2 x 1,5	2.382,80	30,0	30 x 0,26	7,6	97
3 x 1,5	2.711,92	45,0	30 x 0,26	8,0	117
4 x 1,5	3.243,92	60,0	30 x 0,26	8,8	145
5 x 1,5	3.855,69	75,0	30 x 0,26	9,6	175
7 x 1,5	4.586,18	105,0	30 x 0,26	10,9	220
12 x 1,5	8.901,68	180,0	30 x 0,26	14,6	413
16 x 1,5	11.050,64	240,0	30 x 0,26	16,2	520
24 x 1,5	16.680,27	360,0	30 x 0,26	20,4	811
2 x 2,5	3.468,57	50,0	50 x 0,26	9,2	146
3 x 2,5	3.979,32	75,0	50 x 0,26	9,7	179
4 x 2,5	4.722,54	100,0	50 x 0,26	10,6	222
5 x 2,5	5.734,49	125,0	50 x 0,26	11,6	268
7 x 2,5	7.068,10	175,0	50 x 0,26	12,6	339
12 x 2,5	16.205,13	300,0	50 x 0,26	17,1	609

Number of cores and nominal cross section mm²	Price EUR / km	Copper figure kg/km	Cond. construction (appr. value) mm	Overall diameter appr. mm	Weight appr. kg / km
2 x 4	4.893,21	80,0	50 x 0,31	10,8	210
3 x 4	5.455,96	120,0	50 x 0,31	11,5	261
4 x 4	7.004,36	160,0	50 x 0,31	13,2	346
5 x 4	8.583,03	200,0	50 x 0,31	14,3	418
7 x 4	11.460,60	280,0	50 x 0,31	15,6	530
4 x 6	10.058,72	240,0	84 x 0,31	15,6	497
5 x 6	11.939,76	300,0	84 x 0,31	17,6	631
4 x 10	15.982,65	400,0	80 x 0,41	19,1	778
4 x 16	23.077,28	640,0	128 x 0,41	23,4	1.197
4 x 25	34.498,20	1.000,0	200 x 0,41	28,6	1.827

SiHFP

Silicone Sheathed Cable with Steel Wire Braiding

Application:

In dry, humid and wet locations as well as in the open-air for low mechanical stress, particularly at high ambient temperatures. The armouring of galvanised steel wires protects the cable from mechanical damages.

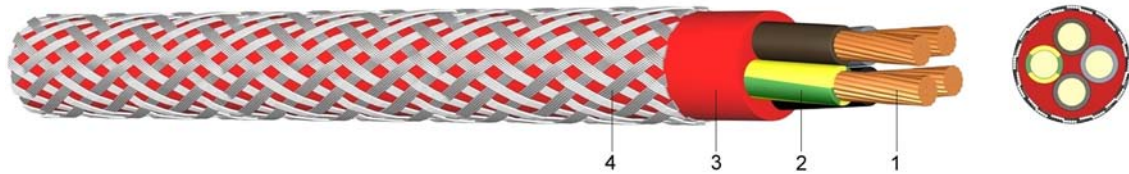

Construction:

- 1 fine-stranded tinned or bare copper
- 2 core insulation of silicone (2G11)
- 3 outer sheath of silicone (2GM1), reddish brown
- 4 armouring of galvanised steel wire braiding

Standards:

DIN VDE 0207 part 20
 DIN EN 60228 class 5 (construction)
 HD 308 S2 (core identification)

Technical data:

Nominal voltage U ₀ /U	[V]	300 / 500 Volt
Test voltage	[V] _{AC}	2000
Temperature range	in motion temporary resilient	-60°C till +180°C +250°C
Flammability	standard	EN 60332-1-2

Number of cores and nominal cross section mm ²	Price	Copper figure	Cond. construction (appr. value)	Overall diameter	Weight
	EUR / km	kg/km	mm	appr. mm	appr. kg / km
2 x 0,75	2.823,87	15,0	24 x 0,21	7,2	95
3 x 0,75	2.962,05	22,5	24 x 0,21	7,6	109
4 x 0,75	3.536,17	30,0	24 x 0,21	8,8	151
5 x 0,75	3.924,43	37,5	24 x 0,21	9,5	180
2 x 1	2.853,41	20,0	32 x 0,21	7,4	104
2 x 1,5	3.295,76	30,0	30 x 0,26	8,6	147
3 x 1,5	3.551,65	45,0	30 x 0,26	9,0	168
4 x 1,5	4.128,67	60,0	30 x 0,26	9,8	205
5 x 1,5	4.736,53	75,0	30 x 0,26	10,6	246
7 x 1,5	5.549,45	105,0	30 x 0,26	11,4	292
12 x 1,5	11.021,66	180,0	30 x 0,26	15,8	496
3 x 2,5	4.886,23	75,0	50 x 0,26	10,7	236
4 x 2,5	5.649,36	100,0	50 x 0,26	11,6	281
5 x 2,5	6.593,95	125,0	50 x 0,26	12,6	341
4 x 4	7.958,42	160,0	50 x 0,31	14,4	424

SiFCuSi

Silicone Sheathed Cable with Copper Braiding

Application:

In dry, humid and wet locations as well as in the open-air for low mechanical stress, particularly at high ambient temperatures. The copper braiding optimises protection against high-frequency external interference.

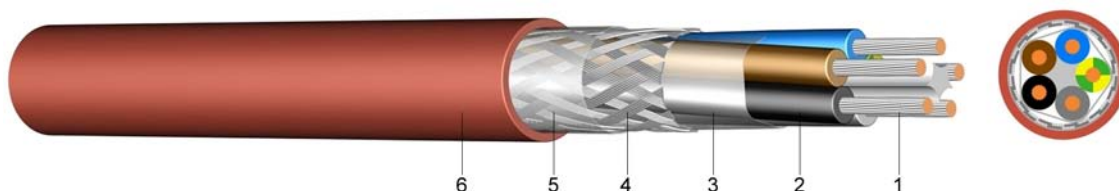

Construction:

- 1 fine-stranded tinned or bare copper
- 2 core insulation of silicone (2G11)
- 3 wrapped with PETP foil
- 4 screen of tinned copper braiding
- 5 wrapped with PETP foil
- 6 outer sheath of silicone (2GM1), reddish brown

Standards:

DIN VDE 0207 part 20
 DIN EN 60228 class 5 (construction)
 HD 308 S2 (core identification)

Technical data:

Nominal voltage U ₀ /U		[V]	300 / 500 Volt
Test voltage		[V] _{Ac}	2000
Temperature range	in motion temporary resilient		-60°C till +180°C +250°C
Flammability	standard		EN 60332-1-2

Number of cores and nominal cross section mm ²	Price EUR / km	Copper figure kg/km	Cond. construction (app.value) mm	Overall diameter appr. mm	Weight appr. kg / km
2 x 0,75	4.762,01	45	24 x 0,21	7,0	72
3 x 0,75	5.204,00	53	24 x 0,21	7,4	88
4 x 0,75	5.806,85	64	24 x 0,21	8,4	114
5 x 0,75	6.824,01	77	24 x 0,21	9,1	135
7 x 0,75	7.544,81	95	24 x 0,21	9,8	166
2 x 1	5.024,29	50	32 x 0,21	7,2	79
3 x 1	5.485,01	63	32 x 0,21	8,0	105
4 x 1	6.259,77	79	32 x 0,21	8,7	129
5 x 1	7.340,91	90	32 x 0,21	9,4	150
7 x 1	8.189,54	113	32 x 0,21	10,1	189
2 x 1,5	6.127,53	69	30 x 0,26	8,2	103
3 x 1,5	6.840,54	85	30 x 0,26	8,6	128
4 x 1,5	7.872,11	103	30 x 0,26	9,4	158
5 x 1,5	9.407,35	127	30 x 0,26	10,2	188
7 x 1,5	10.620,84	162	30 x 0,26	11,2	250
12 x 1,5	17.279,57	253	30 x 0,26	15,4	433
3 x 2,5	9.344,54	127	50 x 0,26	10,3	189
4 x 2,5	10.856,61	153	50 x 0,26	11,4	249
5 x 2,5	13.054,13	184	50 x 0,26	12,4	293

Ignition Wire Silicone 16 kV

Application: In automobiles and similar systems.



Construction:
 1 fine-stranded tinned copper
 2 core insulation of silicone
 3 fibreglass braiding
 4 outer sheath of silicone, blue

Standards:
 DIN VDE 0282 part 1
 DIN EN 60228 class 5 (construction)
 VDE 0207 part 21

Technical data:

Nominal voltage U ₀ /U		[V]	16000 Volt
Test voltage		[V] _{AC}	20000
Temperature range	in motion temporary resilient		-60°C till +180°C +250°C
Bending radius	min.	x diameter	7,5
Flammability	standard		EN 60332-1-2

Nominal cross section	Colours	Price	Copper figure	Cond. construction (appr. value)	Overall diameter	Weight
mm ²		EUR / km	kg/km	mm	mm	appr. kg / km
1,5	bl	2.773,05	15	30 x 0,25	8,5	92

E-YY

PVC Insulated Heavy Current Cable 0,6/1kV Single or Multi Core

Application:

This power cable is suitable for fixed installations, preferably in cable ducts, indoors, outdoors, in water or underground if no mechanical damage is to be expected.

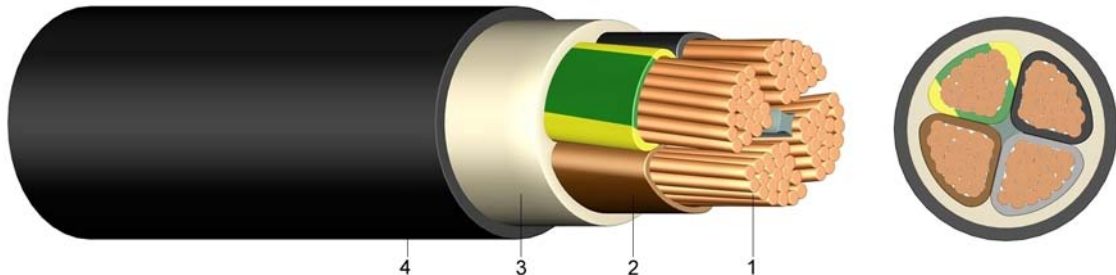

Construction:

- 1 solid (RE) or stranded (RM/SM) bare copper
- 2 core insulation of polyvinylchloride (PVC)
- 3 PVC core covering or taping
- 4 outer sheath of polyvinylchloride (PVC), black

Information:

short circuit temperature (max. 5 sec.)
 $\leq 300\text{mm}^2 \rightarrow 160^\circ\text{C}$
 $> 300\text{mm}^2 \rightarrow 140^\circ\text{C}$

Standards:

ÖVE-K 603
 DIN EN 60228 class 1 and 2 (construction)
 HD 308 S2 (core identification)

Technical data:

Nominal voltage U_0/U		[V]	600 / 1000 Volt
Test voltage		[V] _{AC}	4000
Temperature range	in motion		- 5°C till +70°C
	fixed		-20°C till +70°C
Bending radius	single-core style	x diameter	15
	multi-core style	x diameter	12
Flammability	standard		EN 60332-1-2

Number of cores and nominal cross section	Price EUR / km	Price EUR / km	Copper figure	Overall diameter	Weight	Current carrying capacity ground	Current carrying capacity air
mm ²	J	O	kg/km	appr. mm	appr. kg / km	A	A
1 x 16 RE	1.830,20	1.617,35	160	11	250	107	84
1 x 25 RM	2.478,40	2.276,26	250	12	350	138	114
1 x 35 RM	3.378,45	2.995,08	350	13	460	164	139
1 x 50 RM		3.869,65	500	15	600	195	169
1 x 70 RM	5.879,41	5.307,28	700	17	820	238	213
1 x 95 RM	8.047,68	7.224,13	950	19	1.080	286	264
1 x 120 RM	9.589,05	8.685,73	1.200	21	1.310	325	307
1 x 150 RM	11.610,04	10.422,87	1.500	23	1.600	365	352
1 x 185 RM	14.746,09	13.238,26	1.850	25	2.000	413	406
1 x 240 RM	19.254,26	16.952,15	2.400	28	2.500	479	483
1 x 300 RM		21.923,98	3.000	30	3.180	541	557
1 x 400 RM		27.014,69	4.000	32	3.180	614	646
1 x 500 RM		34.208,69	5.000	34	3.180	693	747
1 x 630 RM		40.932,67	6.300	42	3.180	777	858

Number of cores and nominal cross section mm ²	Price	Price	Copper figure	Overall diameter	Weight	Current carrying capacity ground	Current carrying capacity air
	EUR / km J	EUR / km O	kg/km	appr. mm	appr. kg / km	A	A
2 x 1,5 RE		940,06	30	11	220	27	20
2 x 2,5 RE		1.159,81	50	12	267	36	25
2 x 4 RE		1.941,16	80	14	342	47	34
2 x 6 RE		2.051,04	120	15	412	59	43
2 x 10 RE		2.875,28	200	16	510	79	59
2 x 16 RM		5.160,84	320	18	670	102	79
3 x 1,5 RE	1.098,76	1.098,76	45	11	244	27	20
3 x 2,5 RE	1.465,03	1.465,03	75	12	294	36	25
3 x 4 RE	2.148,71	2.148,71	120	14	393	47	34
3 x 6 RE	2.673,67	2.673,67	180	15	481	59	43
3 x 10 RE	3.833,70	3.833,70	300	16	645	79	59
3 x 16 RE	5.570,85	5.570,85	480	18	872	102	79
3 x 16 RM	5.810,45	5.810,45	480	19	872	102	79
3 x 25 RM	8.446,13	8.446,13	750	21	1.350	133	106
3 x 35 SM	9.763,96	9.763,96	1.050	22	1.460	159	129
3 x 50 SM		12.699,14	1.500	26	1.750	188	157
3 x 70 SM		17.850,67	2.100	29	2.400	232	199
3 x 95 SM		23.840,83	2.850	33	3.560	280	246
3 x 120 SM		29.591,38	3.600	37	4.310	318	285
3 x 150 SM		35.581,54	4.500	41	5.310	359	326
3 x 185 SM		44.686,58	5.550	47	6.630	406	374
3 x 240 SM		58.583,75	7.200	52	8.480	473	445
3 x 25/16 RM/RE	9.704,06	9.704,06	910	22	1.513	133	106
3 x 35/16 SM/RE	11.860,51	11.860,51	1.210	23	1.804	159	129
3 x 50/25 SM/RM	14.975,40	14.975,40	1.750	28	2.349	188	157
3 x 70/35 SM	20.246,74	20.246,74	2.450	32	3.117	232	199
3 x 95/50 SM	26.716,10	26.716,10	3.350	36	4.167	280	246
3 x 120/70 SM	34.143,90	34.143,90	4.300	39	5.190	318	285
3 x 150/70 SM	40.373,67	40.373,67	5.200	43	6.161	359	326
3 x 185/95 SM	52.114,37	52.114,37	6.500	50	7.673	406	374
3 x 240/120 SM	65.292,73	65.292,73	8.400	56	9.850	473	445
3 x 300/150 SM	95.100,45		10.500	66	11.900	535	511
4 x 1,5 RE	1.318,52	1.318,52	60	11	278	27	20
4 x 2,5 RE	1.782,44	1.749,13	100	12	340	36	25
4 x 4 RE	2.527,17	2.527,17	160	14	460	47	34
4 x 6 RE	3.125,38	3.125,38	240	15	570	59	43
4 x 10 RE	4.324,90	4.324,90	400	17	775	79	59
4 x 10 RM	5.055,70	5.055,70	400	18	775	79	59
4 x 16 RE	6.469,38	6.469,38	640	19	1.072	102	79
4 x 16 RM	7.104,34	7.104,34	640	20	1.072	102	79
4 x 25 RM	10.183,27	10.183,27	1.000	22	1.632	133	106
4 x 35 SM	13.417,95	13.417,95	1.400	23	1.959	159	129
4 x 50 SM	15.933,82	15.933,82	2.000	28	2.595	188	157
4 x 70 SM	22.403,19	22.403,19	2.800	32	3.488	232	199
4 x 95 SM	30.669,61	30.669,61	3.800	36	4.637	280	246
4 x 120 SM	37.737,99	37.737,99	4.800	39	5.689	318	285
4 x 150 SM	45.285,60	45.285,60	6.000	45	6.973	359	326
4 x 185 SM	56.307,49	56.307,49	7.400	52	8.663	406	374
4 x 240 SM	74.158,15	74.158,15	9.600	58	11.140	473	445
5 x 1,5 RE	1.587,11	1.587,11	75	13	317	*	*
5 x 2,5 RE	2.136,49		125	14	391	*	*
5 x 4 RE	3.064,33		200	16	537	*	*
5 x 6 RE	3.760,22		300	17	672	*	*
5 x 10 RE	5.510,95		500	19	921	*	*
5 x 10 RM	5.726,59		500	20	921	*	*
5 x 16 RE	8.026,81		800	22	1.294	*	*

Number of cores and nominal cross section	Price EUR / km	Price EUR / km	Copper figure	Overall diameter	Weight	Current carrying capacity ground	Current carrying capacity air
mm ²	J	O	kg/km	appr. mm	appr. kg / km	A	A
5 x 16 RM	8.841,47		1.250	27	2.004	*	*
5 x 25 RM	14.016,97		1.250	27	2.004	*	*
5 x 35 RM	18.090,27		1.750	28	2.575	*	*
5 x 50 RM	24.200,24		2.500	34	3.193	*	*
5 x 70 RM	34.742,92		3.500	38	4.319	*	*
5 x 95 RM	47.082,65		4.750	44	5.783	*	*
5 x 120 RM	55.708,47		6.000	48	7.095	*	*
5 x 150 RM	66.850,50		7.500	59	8.240	*	*
7 x 1,5 RE	1.904,53	1.904,53	105	13	376	*	*
10 x 1,5 RE	2.869,01	2.869,01	150	16	495	*	*
12 x 1,5 RE	3.174,21	3.174,21	180	18	440	*	*
14 x 1,5 RE	3.540,46	3.540,46	210	19	494	*	*
16 x 1,5 RE	4.089,86	4.089,86	240	20	600	*	*
19 x 1,5 RE	4.578,19	4.578,19	285	19	614	*	*
21 x 1,5 RE		5.240,17	315	22	700	*	*
24 x 1,5 RE	5.982,17	5.982,17	360	23	769	*	*
30 x 1,5 RE	7.325,11	7.325,11	450	25	918	*	*
40 x 1,5 RE	9.879,41		600	27	1.250	*	*
7 x 2,5 RE	3.174,21	3.174,21	175	14	472	*	*
10 x 2,5 RE	4.639,24	4.552,53	250	19	530	*	*
12 x 2,5 RE	5.493,83	5.493,83	300	20	578	*	*
14 x 2,5 RE	6.226,35	6.226,35	350	21	680	*	*
16 x 2,5 RE	7.080,94		400	22	750	*	*
19 x 2,5 RE	8.057,62	8.057,62	475	23	870	*	*
21 x 2,5 RE	9.250,02		525	24	900	*	*
24 x 2,5 RE	9.644,73	9.644,73	600	25	1.035	*	*
30 x 2,5 RE	12.330,60	12.330,60	750	27	1.300	*	*
40 x 2,5 RE	13.495,74		1.000	30	1.700	*	*
7 x 4 RE	4.163,10		280	19	600	*	*
7 x 6 RE	6.873,39		420	20	760	*	*
7 x 10 RE	9.704,06		700	22	1.080	*	*

* The current carrying capacity of the cables depends on the number of cores loaded (see DIN VDE 0276-627)

Aislamiento de PVC pesado Cable corriente 0,6 / 1 kV
Individual y Multicore

NY Y

PVC Insulated Heavy Current Cable 0,6/1kV Single and Multicore

Application:

Este cable de alimentación es adecuado para instalaciones fijas, preferentemente en conductos de cables, en interiores, al aire libre, en el agua o bajo tierra si no hay daño mecánico es ser esperado.

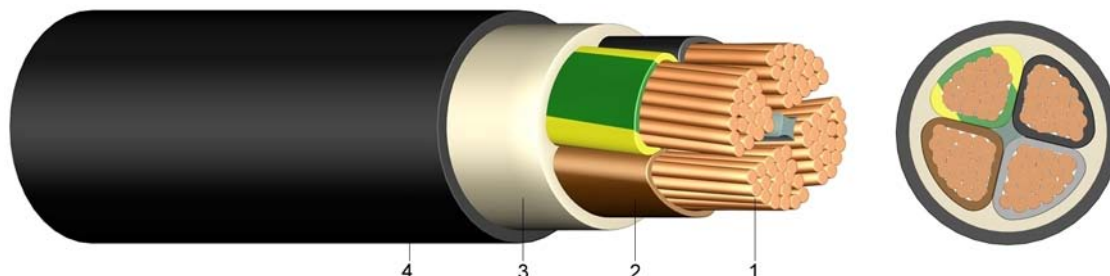

Construction:

- 1 solid (RE) or stranded (RM/SM) bare copper
- 2 core insulation of polyvinylchloride (PVC)
- 3 PVC core covering or taping
- 4 outer sheath of polyvinylchloride (PVC), black

Information: short circuit temperature on core (max. 5 sec.)
 <=300mm² --> 160°C
 >300mm² --> 140°C

Standards: DIN VDE 0276-603
 HD 603 S1:1994 + A2:2003
 DIN EN 60228 class 1 and 2 (construction)
 HD 308 S2 (core identification)

Technical data:

Nominal voltage U ₀ /U	estilo de un solo núcleo	[V]	
Test voltage		[V] _{AC}	600 / 1000 Volt
Temperature range	in motion		4000
	fixed		- 5°C till +70°C
Bending radius	radio de curvatura	single-core style	-20°C till +70°C
		multi-core style	15
Flammability	Inflamabilidad	standard	12
			EN 60332-1-2

Number of cores and nominal cross section mm ²	Price	Price	Copper figure	Overall diameter	Weight	Current carrying capacity ground	Current carrying capacity air
	EUR / km J	EUR / km O	kg/km	appr. mm	appr. kg / km	A	A
1 x 16 RE	1.830,20	1.617,35	160	11	233	107	84
1 x 25 RM	2.478,40	2.276,26	250	12	370	138	114
1 x 35 RM	3.378,45	2.995,08	350	14	480	164	139
1 x 50 RM	4.311,17	3.869,65	500	16	640	195	169
1 x 70 RM	5.879,41	5.307,28	700	17	850	238	213
1 x 95 RM	8.047,68	7.224,13	950	19	1.120	286	264
1 x 120 RM	9.589,05	8.685,73	1.200	21	1.375	325	307
1 x 150 RM	11.610,04	10.422,87	1.500	23	1.660	365	352
1 x 185 RM	14.746,09	13.238,26	1.850	25	2.050	413	406
1 x 240 RM	19.254,26	16.952,15	2.400	28	2.634	479	483
1 x 300 RM	24.901,27	21.923,98	3.000	30	3.295	541	557
1 x 400 RM		27.014,69	4.000	32	4.231	614	646
1 x 500 RM		34.208,69	5.000	34	5.284	693	747
1 x 630 RM		40.932,67	6.300	42	6.850	777	858

Number of cores and nominal cross section mm ²	Price		Copper figure kg/km	Overall diameter appr. mm	Weight appr. kg / km	Current carrying capacity ground A	Current carrying capacity air A
	EUR / km J	EUR / km O					
2 x 1,5 RE		940,06	30	11	220	27	20
2 x 2,5 RE		1.159,81	50	12	267	36	25
2 x 4 RE		1.941,16	80	14	342	47	34
2 x 6 RE		2.051,04	120	15	412	59	43
2 x 10 RE		2.875,28	200	16	510	79	59
2 x 16 RM		5.160,84	320	18	670	102	79
3 x 1,5 RE	1.098,76	1.098,76	45	13	244	27	20
3 x 2,5 RE	1.465,03	1.465,03	75	14	294	36	25
3 x 4 RE	2.148,71	2.148,71	120	16	393	47	34
3 x 6 RE	2.673,67	2.673,67	180	17	481	59	43
3 x 10 RE	3.833,70	3.833,70	300	18	645	79	59
3 x 16 RE	5.570,85	5.570,85	480	20	872	102	79
3 x 16 RM	5.810,45	5.810,45	480	20	872	102	79
3 x 25 RM	8.446,13	8.446,13	750	25	1.350	133	106
3 x 35 SM	9.763,96	9.763,96	1.050	25	1.460	159	129
3 x 50 SM		12.699,14	1.500	25	1.460	159	129
3 x 70 SM		17.850,67	2.100	25	1.460	159	129
3 x 95 SM		23.840,83	2.850	35	3.560	280	246
3 x 120 SM		29.591,38	3.600	38	4.310	318	285
3 x 150 SM		35.581,54	4.500	42	5.310	359	326
3 x 185 SM		44.686,58	5.550	47	6.630	406	374
3 x 240 SM		58.583,75	7.200	53	8.480	473	445
3 x 25/16 RM/RE	9.704,06	9.704,06	910	25	1.513	133	106
3 x 35/16 SM/RE	11.860,51	11.860,51	1.210	27	1.804	159	129
3 x 50/25 SM/RM	14.975,40	14.975,40	1.750	31	2.349	188	157
3 x 70/35 SM	20.246,74	20.246,74	2.450	35	3.117	232	199
3 x 95/50 SM	26.716,10	26.716,10	3.350	39	4.167	280	246
3 x 120/70 SM	34.143,90	34.143,90	4.300	44	5.190	318	285
3 x 150/70 SM	40.373,67	40.373,67	5.200	47	6.161	359	326
3 x 185/95 SM	52.114,37	52.114,37	6.500	53	7.673	406	374
3 x 240/120 SM	65.292,73	65.292,73	8.400	59	9.850	473	445
3 x 300/150 SM	95.100,45		10.500	65	11.900	535	511
4 x 1,5 RE	1.318,52	1.318,52	60	14	278	27	20
4 x 2,5 RE	1.782,44	1.749,13	100	15	340	36	25
4 x 4 RE	2.527,17	2.527,17	160	17	460	47	34
4 x 6 RE	3.125,38	3.125,38	240	18	570	59	43
4 x 10 RE	4.324,90	4.324,90	400	20	775	79	59
4 x 10 RM	5.055,70	5.055,70	400	20	775	79	59
4 x 16 RE	6.469,38	6.469,38	640	22	1.072	102	79
4 x 16 RM	7.104,34	7.104,34	640	22	1.072	102	79
4 x 25 RM	10.183,27	10.183,27	1.000	27	1.632	133	106
4 x 35 SM	13.417,95	13.417,95	1.400	27	1.959	159	129
4 x 50 SM	15.933,82	15.933,82	2.000	32	2.595	188	157
4 x 70 SM	22.403,19	22.403,19	2.800	36	3.488	232	199
4 x 95 SM	30.669,61	30.669,61	3.800	41	4.637	280	246
4 x 120 SM	37.737,99	37.737,99	4.800	43	5.689	318	285
4 x 150 SM	45.285,60	45.285,60	6.000	49	6.973	359	326
4 x 185 SM	56.307,49	56.307,49	7.400	54	8.663	406	374
4 x 240 SM	74.158,15	74.158,15	9.600	60	11.140	473	445
5 x 1,5 RE	1.587,11	1.587,11	75	15	317	*	*
5 x 2,5 RE	2.136,49		125	16	391	*	*
5 x 4 RE	3.064,33		200	18	537	*	*
5 x 6 RE	3.760,22		300	19	672	*	*
5 x 10 RE	5.510,95		500	21	921	*	*
5 x 10 RM	5.726,59		500	21	921	*	*
5 x 16 RE	8.026,81		800	24	1.294	*	*

Number of cores and nominal cross section mm ²	Price		Copper figure kg/km	Overall diameter appr. mm	Weight appr. kg / km	Current carrying capacity ground A	Current carrying capacity air A
	EUR / km J	EUR / km O					
5 x 16 RM	8.841,47		800	24	1.294	*	*
5 x 25 RM	14.016,97		1.250	29	2.004	*	*
5 x 35 RM	18.090,27		1.750	30	2.575	*	*
5 x 50 RM	24.200,24		2.500	36	3.193	*	*
5 x 70 RM	34.742,92		3.500	40	4.319	*	*
5 x 95 RM	47.082,65		4.750	46	5.783	*	*
5 x 120 RM	55.708,47		6.000	50	7.095	*	*
5 x 150 RM	66.850,50		7.500	59	8.240	*	*
7 x 1,5 RE	1.904,53	1.904,53	105	16	376	*	*
10 x 1,5 RE	2.869,01	2.869,01	150	19	495	*	*
12 x 1,5 RE	3.174,21	3.174,21	180	18	440	*	*
14 x 1,5 RE	3.540,46	3.540,46	210	20	494	*	*
16 x 1,5 RE	4.089,86	4.089,86	240	21	600	*	*
19 x 1,5 RE	4.578,19	4.578,19	285	22	614	*	*
21 x 1,5 RE		5.240,17	315	23	700	*	*
24 x 1,5 RE	5.982,17	5.982,17	360	24	769	*	*
30 x 1,5 RE	7.325,11	7.325,11	450	26	918	*	*
40 x 1,5 RE	9.879,41		600	29	1.250	*	*
7 x 2,5 RE	3.174,21	3.174,21	175	17	472	*	*
10 x 2,5 RE	4.639,24	4.552,53	250	20	530	*	*
12 x 2,5 RE	5.493,83	5.493,83	300	21	578	*	*
14 x 2,5 RE	6.226,35	6.226,35	350	22	680	*	*
16 x 2,5 RE	7.080,94		400	23	750	*	*
19 x 2,5 RE	8.057,62	8.057,62	475	24	870	*	*
21 x 2,5 RE	9.250,02		525	25	900	*	*
24 x 2,5 RE	9.644,73	9.644,73	600	26	1.035	*	*
30 x 2,5 RE	12.330,60	12.330,60	750	28	1.300	*	*
40 x 2,5 RE	13.495,74		1.000	31	1.700	*	*
7 x 4 RE	4.163,10		280	18	600	*	*
7 x 6 RE	6.873,39		420	20	760	*	*
7 x 10 RE	9.704,06		700	22	1.080	*	*

* The current carrying capacity of the cables depends on the number of cores loaded (see DIN VDE 0276-627)

E-Y2Y

PVC Insulated Heavy Current Cable with Copper Conductor and PE Outer Sheath

Application:

This power cable is suitable for fixed installations, preferably in cable ducts, indoors, outdoors, in water or underground if no mechanical damage is to be expected.

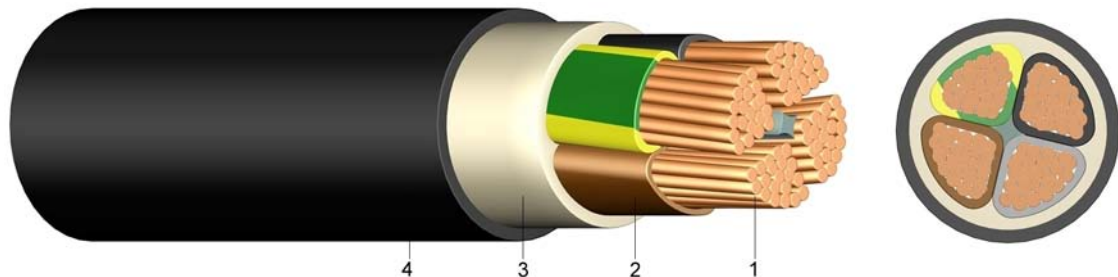

Construction:

- 1 solid (RE) or stranded (RM/SM) bare copper
- 2 core insulation of polyvinylchloride (PVC)
- 3 PVC core covering or taping
- 4 outer sheath of polyethylene (PE), black, Shore-hardness >55

Standards:

ÖVE K 23 and K 603
 HD 603 S1:1994 + A2:2003
 DIN EN 60228 class 1 and 2 (construction)
 HD 308 S2 (core identification)

Technical data:

Nominal voltage U ₀ /U		[V]	600 / 1000 Volt
Test voltage		[V] _{AC}	4000
Temperature range	in motion		- 5°C till +70°C
	fixed		-20°C till +70°C
Operating temperature	short circuit	°C	160
Short circuit time	max.	[sec]	5
Bending radius	single-core style	x diameter	15
	multi-core style	x diameter	12
Flammability	standard		EN 60332-1-2

Number of cores and nominal cross section mm ²	Price	Price	Copper figure kg/km	Overall diameter appr. mm	Weight appr. kg / km	Current carrying capacity ground A	Current carrying capacity air A
	EUR / km J	EUR / km O					
4 x 6 RE	3.130,86	3.130,86	240	15	570	56	43
4 x 10 RE	4.310,37	4.310,37	400	20	775	75	60
4 x 10 RM	5.124,15		400	20	775	75	60
4 x 16 RE	6.448,49		640	21	1.050	98	80
4 x 16 RM	7.264,82		640	22	1.100	98	80
4 x 25 RM	10.476,07		1.000	25	1.632	128	106
4 x 35 SM	12.206,19		1.400	27	1.959	157	131
4 x 50 SM	16.231,99		2.000	32	2.595	185	159
5 x 6 RE	3.569,20		300	17	672	*	*
5 x 10 RE	5.563,41		500	21	921	*	*

* The current carrying capacity of the cables depends on the number of cores loaded (see DIN VDE 0276-627)

E-AYY

PVC Insulated Cable with Aluminium Conductor

Application:

This power cable is suitable for fixed installations, preferably in cable ducts, indoors, outdoors, in water or underground if no mechanical damage is to be expected.

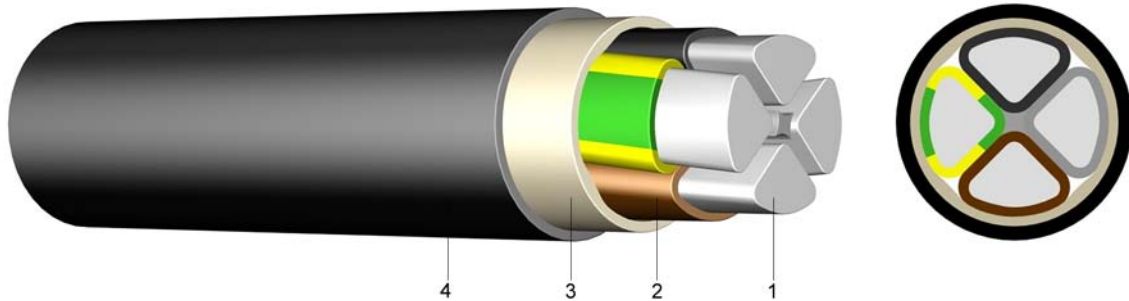

Construction:

- 1 solid (SE) or stranded (RM/SM) aluminium wires
- 2 core insulation of polyvinylchloride (PVC)
- 3 PVC core covering or taping
- 4 outer sheath of polyvinylchloride (PVC), black

Information:

short circuit temperature at core (max. 5 sec.)
 $\leq 300\text{mm}^2 \rightarrow 160^\circ\text{C}$
 $> 300\text{mm}^2 \rightarrow 140^\circ\text{C}$

Standards:

ÖVE K 23 and K 603
 HD 603 S1
 DIN EN 60228 class 1 and 2 (construction)
 HD 308 S2 (core identification)

Technical data:

Nominal voltage U_0/U		[V]	600 / 1000 Volt
Test voltage		[V] _{AC}	4000
Temperature range	in motion		- 5°C till +70°C
	fixed		-20°C till +70°C
Bending radius	single-core style	x diameter	15
	multi-core style	x diameter	12
Flammability	standard		EN 60332-1-2

Number of cores and nominal cross section mm ²	Price	Price	Aluminium figure kg/km	Overall diameter appr. mm	Weight appr. kg / km	Current carrying capacity ground A	Current carrying capacity air A
	EUR / km J	EUR / km O					
1 x 25 RM		1.875,43	74	11	174	106	87
1 x 35 RM		2.178,54	103	12	209	127	107
1 x 50 RM		2.775,78	147	14	282	151	131
1 x 70 RM	3.778,03	3.434,58	206	16	363	185	166
1 x 95 RM		4.411,29	279	18	520	222	205
1 x 120 RM	5.978,31	5.434,82	353	19	557	253	239
1 x 150 RM	7.042,50	6.402,29	441	21	674	284	273
1 x 185 RM	8.364,73	7.604,30	544	24	826	322	317
1 x 240 RM		9.463,49	706	26	1.052	375	378
1 x 300 RM		13.171,90	882	29	1.282	425	437
1 x 400 RM		15.830,31	1.200	32	1.598	487	513
1 x 500 RM		19.787,89	1.510	36	2.022	558	600
1 x 630 RM		26.128,00	1.900	40	2200	635	701

Number of cores and nominal cross section mm ²	Price	Price	Aluminium figure	Overall diameter	Weight	Current carrying capacity ground	Current carrying capacity air
	EUR / km J	EUR / km O	kg/km	appr. mm	appr. kg / km	A	A
3 x 240/120 SM	36.616,91	36.616,91	2.470	55	4.215	364	338
4 x 25 RM	6.998,49	6.998,49	294	25	887	102	82
4 x 35 SM	8.050,16	8.050,16	412	26	796	123	100
4 x 50 SM	9.540,98	9.540,98	588	27	1.017	144	119
4 x 70 SM	12.697,76	12.697,76	823	30	1.312	179	152
4 x 95 SM	16.399,36	16.399,36	1.117	34	1.698	215	186
4 x 120 SM	20.512,62	20.512,62	1.411	40	2.459	245	216
4 x 150 SM	23.586,59	23.586,59	1.764	43	2.594	275	246
4 x 185 SM	30.640,63	30.640,63	2.176	50	3.777	313	285
4 x 240 SM	38.991,96	38.991,96	2.822	54	4.106	364	338
4 x 150 SE	22.167,21	22.167,21	1.764	45	2.594	275	246
5 x 25 RM	10.140,00		368	26	1.018	102	81
5 x 35 RM	11.080,00		515	30	1316	121	99
5 x 50 SM	12.864,00		781	32	1549	144	119
5 x 70 SM	19.983,00		1.071	37	2021	179	152
5 x 95 SM	25.433,00		1.484	41	2598	215	186
5 x 120 SM	31.491,00		1.875	47	3201	245	216

E-AY2Y

PVC Insulated Heavy Current Cable with Aluminium Conductor and PE Outer Sheath

Application:

This power cable is suitable for fixed installations in cable ducts outdoors, in water or underground if no mechanical damage is to be expected.

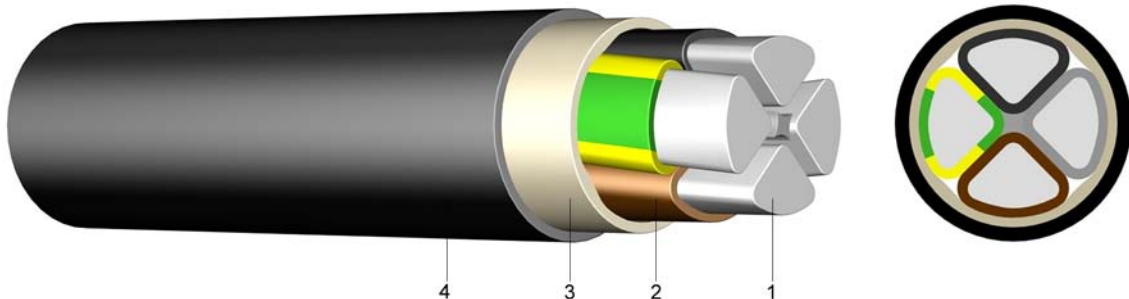

Construction:

- 1 solid (RE/SE) or stranded (RM/SM) aluminium wire
- 2 core insulation of polyvinylchloride (PVC)
- 3 PVC core covering or taping
- 4 outer sheath of polyethylene (PE), black, Shore-hardness HD 60

Standards:

ÖVE K 23 and K 603
 HD 603 S1
 DIN EN 60228 class 1 and 2 (construction)
 HD 308 S2 (core identification)

Technical data:

Nominal voltage U ₀ /U		[V]	600 / 1000 Volt
Test voltage		[V] _{Ac}	4000
Temperature range	in motion		- 5°C till +70°C
	fixed		-20°C till +70°C
Operating temperature	short circuit	°C	160
Bending radius	single-core style	x diameter	15
	multi-core style	x diameter	12
Short circuit time	max.	[sec]	5

Number of cores and nominal cross section mm ²	Price	Price	Aluminium figure kg/km	Overall diameter appr. mm	Weight appr. kg / km	Current carrying capacity ground A	Current carrying capacity air A
	EUR / km J	EUR / km O					
1 x 120 RM	5.815,34		348	20	525	389	302
3 x 240/120 SM		38.008,63	2.470	55	3.994	364	338
4 x 25 RE	6.642,02		294	24	769	102	82
4 x 50 SE	9.539,78		588	28	1.093	144	119
4 x 95 SE	15.526,10	15.526,10	1.117	37	1.930	215	186
4 x 150 SE	23.041,36	23.041,36	1.764	45	2.822	275	246
4 x 25 RM		7.445,75	294	24	769	102	82
4 x 35 SM	8.670,41		412	25	868	123	100
4 x 50 SM	10.269,74	10.269,74	588	28	1.091	144	119
4 x 95 SM	17.426,80	17.426,80	1.117	37	1.930	215	186
4 x 150 SM	24.529,39	24.529,39	1.764	43	2.449	275	246
4 x 185 SM	32.198,98	32.198,98	2.176	48	3.075	313	285
4 x 240 SM	40.373,29	40.373,29	2.822	57	4.509	364	338

E-A2Y

PE Insulated Overhead Line

Application:

This overhead line is particularly suited as a roof pylon cable outdoors, but not underground.

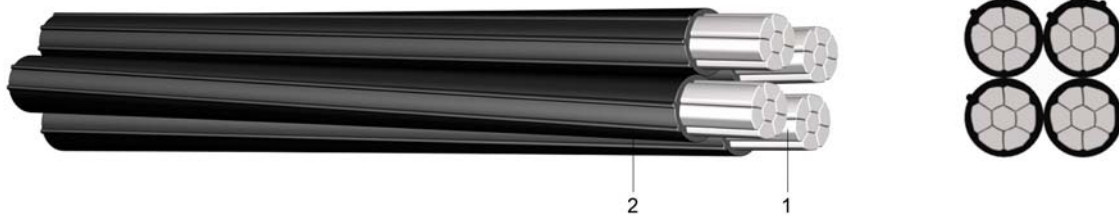

Construction:

1 stranded compacted aluminium wires
2 outer sheath of polyethylene (PE), black

Standards:

ÖVE / ÖNORM E8200-626
HD 626 S1

Technical data:

Nominal voltage U ₀ /U		[V]	600 / 1000 Volt
Test voltage		[V] _{AC}	3500
Temperature range	in motion		-20°C till +90°C
Operating temperature	short circuit	°C	120
Short circuit time	max.	[sec]	5
Bending radius	in motion	x diameter	18

Number of cores and nominal cross section	Price	Aluminium figure	max. overall diameter of insulation	Overall diameter	Weight	Current carrying capacity
mm ²	EUR / km	kg/km	appr. mm	appr. mm	appr. kg / km	air A
2 x 25 RM	2.123,56	147	9	17,4	210	80
4 x 25 RM	3.535,40	294	9	21,0	420	80
4 x 50 RM	5.236,61	588	13	27,5	740	125
4 x 70 RM	7.756,88	823	14	31,9	1.000	160
4 x 95 RM	10.602,24	1.117	16	36,7	1.350	185

NYCY

PVC Insulated Heavy Current Cable with Concentric Conductor

Application:

In dry, humid and wet locations, cable ducts, outdoors, underground and in water.

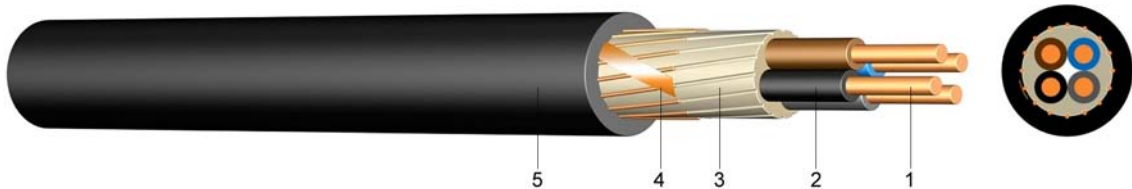

Construction:

- 1 solid (RE) bare copper
- 2 core insulation of polyvinylchloride (PVC)
- 3 PVC core covering or taping
- 4 concentric conductor of copper wires and copper tape
- 5 outer sheath of polyvinylchloride (PVC), black

Standards:

DIN VDE 0276-627
 HD 627 S1:1996 part 1 4H1, 4H2, 7H
 DIN EN 60228 class 1 (construction)
 HD 308 S2 (core identification)

Technical data:

Nominal voltage U ₀ /U		[V]	600 / 1000 Volt
Test voltage		[V] _{Ac}	4000
Temperature range	in motion		- 5°C till +70°C
	fixed		-20°C till +70°C
Operating temperature	short circuit	°C	160
Short circuit time	max.	[sec]	5
Bending radius	one time / fixed	x diameter	12
Bending radius	in motion	x diameter	15
Flammability	standard		EN 60332-1-2

Number of cores and nominal cross section	Price	Copper figure	Overall diameter	Weight	Current carrying capacity ground	Current carrying capacity air
mm ²	EUR / km	kg/km	appr. mm	appr. kg / km	A	A
2 x 1,5 RE/ 1,5	2.278,41	54	12	225	27	20
2 x 2,5 RE/ 2,5	2.659,76	83	14	274	36	29
2 x 4 RE/ 4	3.373,70	128	15	366	47	39
2 x 6 RE/ 6	4.050,97	190	16	448	59	44
3 x 1,5 RE/1,5	2.298,17	73	13	240	27	20
3 x 2,5 RE/ 2,5	2.748,97	113	14	294	36	29
3 x 4 RE/ 4	3.581,31	168	16	413	47	39
3 x 6 RE/ 6	4.395,70	250	17	512	59	44
4 x 1,5 RE/1,5	2.548,71	88	14	271	27	20
4 x 2,5 RE/ 2,5	3.054,86	138	15	336	36	29
4 x 4 RE/ 4	4.154,06	208	17	477	47	39
4 x 6 RE/ 6	5.066,43	309	18	597	59	44
5 x 1,5 RE/1,5	2.842,56	103	15	305	*	*
5 x 2,5 RE/ 2,5	3.582,99	163	17	460	*	*
5 x 4 RE/ 4	4.601,73	248	20	610	*	*

Number of cores and nominal cross section	Price	Copper figure	Overall diameter	Weight	Current carrying capacity ground	Current carrying capacity air
mm²	EUR / km	kg/km	appr. mm	appr. kg / km	A	A
5 x 6 RE/ 6	5.608,54	370	20	720	*	*
5 x 10 RE/ 10	7.822,56	625	23	1.080	*	*
7 x 1,5 RE/ 2,5	3.684,05	139	15	368	*	*
10 x 1,5 RE/ 2,5	4.509,70	183	18	483	*	*
12 x 1,5 RE/ 2,5	4.759,54	214	19	546	*	*
14 x 1,5 RE/ 2,5	6.378,65	244	20	601	*	*
16 x 1,5 RE/ 4	6.316,21	288	20	677	*	*
19 x 1,5 RE/ 4	6.919,29	333	22	747	*	*
24 x 1,5 RE/ 6	8.494,72	430	25	927	*	*
30 x 1,5 RE/ 6	10.002,98	519	26	1.081	*	*
7 x 2,5 RE/ 2,5	4.352,53	208	17	457	*	*
10 x 2,5 RE/ 4	5.670,88	298	20	633	*	*
12 x 2,5 RE/ 4	6.555,47	348	21	719	*	*
16 x 2,5 RE/ 6	8.933,81	470	22	884	*	*
7 x 4 RE/ 4	6.623,45	320	20	660	*	*

* The current carrying capacity of the cables depends on the number of cores loaded (see DIN VDE 0276-627)

E-YCY

PVC Insulated Cable with Concentric Conductor Screen Cross Section 16 mm²

Application:

In dry, humid and wet locations, cable ducts, outdoors, underground and in water.

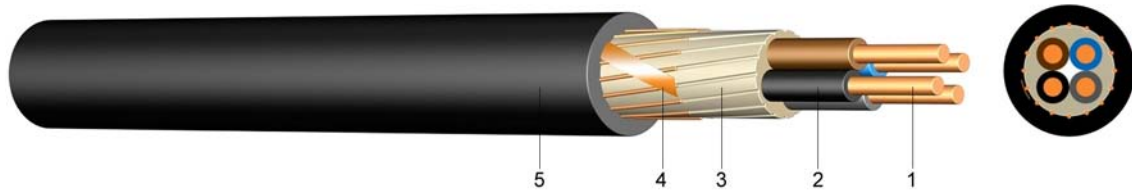

Construction:

- 1 solid (RE) or stranded (RM/SM) bare copper
- 2 core insulation of polyvinylchloride (PVC)
- 3 PVC core covering or taping
- 4 concentric conductor of copper wires and copper tape
- 5 outer sheath of polyvinylchloride (PVC), black

Standards:

ÖVE K23 and K 603
HD 603.S1
DIN EN 60228 class 1 (construction)
HD 308 S2 (core identification)

Technical data:

Nominal voltage U ₀ /U		[V]	600 / 1000 Volt
Test voltage		[V] _{Ac}	4000
Temperature range	in motion		- 5°C till +70°C
	fixed		-20°C till +70°C
Operating temperature	short circuit	°C	160
Short circuit time	max.	[sec]	5
Bending radius	one time / fixed	x diameter	12
Bending radius	in motion	x diameter	15
Flammability	standard		EN 60332-1-2

Number of cores and nominal cross section	Price	Copper figure	Overall diameter	Weight	Current carrying capacity ground	Current carrying capacity air
mm ²	EUR / km	kg/km	appr. mm	appr. kg / km	A	A
4 x 1,5 RE/ 16	3.908,10	250	15	260	26	18
7 x 1,5 RE/ 16	4.794,91	295	17	540	*	*
10 x 1,5 RE/ 16	5.709,07	340	20	660	*	*
12 x 1,5 RE/ 16	6.180,55	370	20	700	*	*
14 x 1,5 RE/ 16	7.029,94	400	21	750	*	*
19 x 1,5 RE/ 16	8.207,78	475	23	900	*	*
24 x 1,5 RE/ 16	9.380,63	550	27	1.110	*	*
30 x 1,5 RE/ 16	11.244,79	640	28	1.260	*	*
4 x 2,5 RE/ 16	4.439,65	290	16	330	34	25
5 x 2,5 RE/ 16	4.762,62	315	17	580	*	*
7 x 2,5 RE/ 16	5.775,72	365	18	630	*	*
10 x 2,5 RE/ 16	7.002,22	440	21	800	*	*
12 x 2,5 RE/ 16	7.759,82	490	22	890	*	*
14 x 2,5 RE/ 16	8.371,99	540	23	980	*	*

Number of cores and nominal cross section	Price	Copper figure	Overall diameter	Weight	Current carrying capacity ground	Current carrying capacity air
mm²	EUR / km	kg/km	appr. mm	appr. kg / km	A	A
19 x 2,5 RE/ 16	9.670,65	665	26	1.180	*	*
24 x 2,5 RE/ 16	12.000,68	790	29	1.450	*	*
30 x 2,5 RE/ 16	14.741,89	940	30	1.630	*	*
2 x 4 RE/ 16	4.512,77	270	16	510	44	34
4 x 4 RE/ 16	5.070,89	350	18	630	44	34
5 x 4 RE/ 16	5.617,32	390	19	730	*	*
7 x 4 RE/ 16	8.221,98	470	24	950	*	*
4 x 6 RE/ 16	5.932,94	430	19	750	56	43
5 x 6 RE/ 16	6.662,41	490	21	860	*	*
4 x 10 RE/ 16	7.845,40	590	22	970	75	60
5 x 10 RE/ 16	9.549,06	690	25	1.200	*	*
5 x 16 RE/ 16	13.051,50	990	27	1.475	*	*

* The current carrying capacity of the cables depends on the number of cores loaded (see DIN VDE 0276-627)

NYCWX

PCV Insulated Heavy Current Cable with Concentric Conductor

Application:

In dry, humid and wet locations, cable ducts, outdoors, underground and in water.

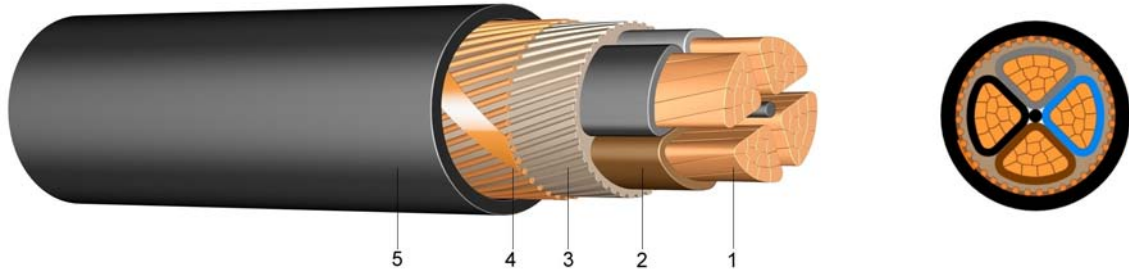

Construction:

- 1 solid or stranded bare copper wire
- 2 core insulation of polyvinylchloride (PVC)
- 3 PVC core covering
- 4 concentric conductor of copper wires and copper tape applied helically
- 5 outer sheath of polyvinylchloride (PVC), black

Standards:

DIN VDE 0276-603
 HD 627 S1:1996 part 1 4H1, 4H2.7H
 DIN EN 60228 class 1 and 2 (construction)
 HD 308 S2 (core identification)

Technical data:

Nominal voltage U ₀ /U		[V]	600 / 1000 Volt
Test voltage		[V] _{AC}	4000
Temperature range	in motion		- 5°C till +70°C
	fixed		-20°C till +70°C
Operating temperature	short circuit	°C	160
Short circuit time	max.	[sec]	5
Bending radius	one time / fixed	x diameter	12
Bending radius	in motion	x diameter	15
Flammability	standard		EN 60332-1-2

Number of cores and nominal cross section	Price	Copper figure	Overall diameter	Weight	Current carrying capacity ground	Current carrying capacity air
mm ²	EUR / km	kg/km	appr. mm	appr. kg / km	A	A
2 x 10 RE/ 10	4.643,60	325	19	660	79	60
3 x 10 RE/ 10	5.447,66	425	20	760	79	60
3 x 16 RE/ 16	7.414,10	670	22	1.040	102	80
3 x 25 RM/ 16	11.576,64	940	26	1.490	133	108
3 x 25 RM/ 25	12.185,68	1.045	26	1.580	133	108
3 x 35 SM/ 16	12.902,18	1.240	27	1.800	160	132
3 x 35 SM/ 35	14.654,56	1.460	29	1.880	160	132
3 x 50 SM/ 25	17.344,76	1.795	30	2.260	190	160
3 x 50 SM/ 50	18.970,95	2.083	31	2.460	190	160
3 x 70 SM/ 35	23.109,57	2.510	33	3.060	234	202
3 x 70 SM/ 70	25.792,34	2.913	34	3.310	234	202
3 x 95 SM/ 50	30.477,79	3.433	38	4.080	280	249
3 x 95 SM/ 95	34.141,68	3.949	40	4.510	280	249
3 x 120 SM/ 70	39.092,43	4.413	42	5.040	319	289
3 x 120 SM/120	43.222,01	4.985	43	5.490	319	289

Number of cores and nominal cross section	Price	Copper figure	Overall diameter	Weight	Current carrying capacity ground	Current carrying capacity air
mm²	EUR / km	kg/km	appr. mm	appr. kg / km	A	A
3 x 150 SM/ 70	44.237,00	5.313	46	6.040	357	329
3 x 150 SM/150	50.479,00	6.219	47	6.750	357	329
3 x 185 SM/ 95	55.513,09	6.649	51	7.510	402	377
3 x 240 SM/120	71.499,46	8.585	57	9.640	463	377
4 x 10 RE/ 10	7.062,13	525	21	890	79	60
4 x 16 RE/ 16	9.280,41	829	23	1.240	102	80
4 x 25 RM/ 16	12.621,43	1.190	28	1.800	133	108
4 x 35 SM/ 16	16.138,60	1.590	28	2.130	160	132
4 x 50 SM/ 25	20.684,08	2.295	33	2.870	190	160
4 x 70 SM/ 35	29.139,02	3.210	36	3.870	234	202
4 x 95 SM/ 50	38.716,06	4.383	43	5.303	280	249
4 x 120 SM/ 70	45.946,91	5.613	46	6.380	319	289
4 x 150 SM/ 70	54.175,63	6.813	51	7.730	357	329
4 x 185 SM/ 95	67.435,82	8.499	57	9.770	402	377
4 x 240 SM/120	88.297,20	10.913	64	12.540	463	443

Copper Rope

Application: For grounding purposes in heavy current systems.



Construction: 1 stranded compacted tinned or bare copper

Standards: soft style: IEC 60228 class 2
hard style: DIN VDE 48201
DIN EN 60228 class 2 (construction)

Number of cores and nominal cross section mm ²	Price EUR / km	Copper figure kg/km	Number of conductor min. / max.	Overall diameter appr.mm	Weight appr. kg / km
bare copper					
1 x 16	1.059,74	160	7 / 6	5,1	142
1 x 25	1.678,99	250	7 / 6	6,3	222
1 x 35	2.328,49	350	7 / 6	7,5	311
1 x 50	3.300,05	500	19 / 6	9,0	444
1 x 70	4.602,53	700	19 / 12	10,5	622
1 x 95	6.381,91	950	19 / 15	12,5	844
1 x 120	7.848,39	1.200	19 / 18	14,0	1.067
1 x 150	9.714,76	1.500	37 / 18	15,2	1.333
1 x 185	12.231,21	1.850	37 / 30	17,5	1.644
1 x 240	15.584,77	2.400	37 / 34	20,2	2.133
tinned copper					
1 x 35	2.561,35	350	7 / 6	7,5	311
1 x 50	3.630,04	500	19 / 6	9,0	444
1 x 70	5.062,80	700	19 / 12	10,5	622
1 x 95	7.020,00	950	19 / 15	12,5	844
1 x 240	17.143,14	2.400	37 / 34	20,2	2.133

(N)YFGY

Three-Core PVC Insulated Cable with Flat Wire Armour

Application:

To be laid directly in ground, in water, outdoors, indoors and in cable ducts if increased mechanical protection is required or if greater tensile stresses are to be expected during installation and operation.

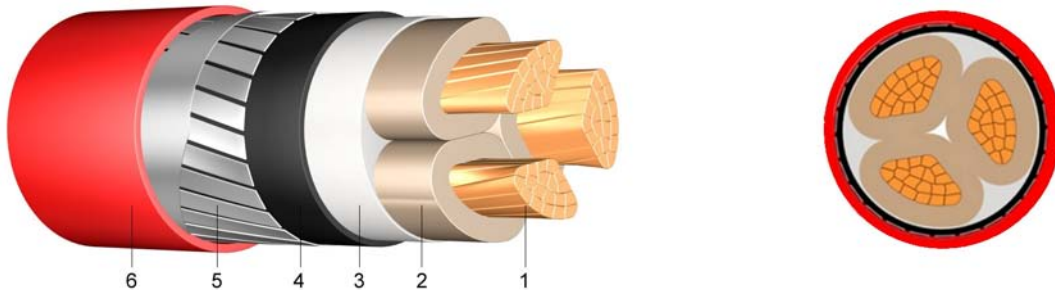

Construction:

- 1 stranded bare copper
- 2 core insulation of polyvinylchloride (PVC-DIV4)
- 3 rubber core covering
- 4 inner sheath of polyvinylchloride (PVC-DMV5)
- 5 armour of galvanised flat steel wires and counter helix
- 6 outer sheath of polyvinylchloride (PVC), red

Standards:

DIN VDE 0271
DIN VDE 0276-603
DIN EN 60228 class 2 (construction)

Technical data:

Nominal voltage U ₀ /U		[V]	3600 / 6000 Volt
Test voltage		[V] _{Ac}	11000
Temperature range	in motion		- 5°C till +70°C
	fixed		-20°C till +70°C
Operating temperature	short circuit	°C	160
Short circuit time	max.	[sec]	5
Bending radius	in motion	x diameter	15
Flammability	standard		EN 60332-1-2

Number of cores and nominal cross section	Price	Copper figure	Overall diameter	Weight	Current carrying capacity ground	Current carrying capacity air
mm ²	EUR / km	kg/km	appr. mm	appr. kg / km	A	A
3 x 50 SM	19.802,31	1.500	41	3.520	175	165
3 x 70 SM	24.873,23	2.100	44	4.345	220	205
3 x 95 SM	32.001,99	2.850	47	5.330	260	250
3 x 120 SM	37.005,80	3.600	49	6.220	295	285
3 x 150 SM	44.192,37	4.500	52	7.120	335	325
3 x 185 SM	53.846,76	5.550	57	8.625	370	380
3 x 240 SM	65.374,27	7.200	59	9.885	425	430

N2XSEY

Three-Core XLPE Insulation Cable with PVC Outer Sheath

Application:

To be laid directly in ground, water, outdoors, indoors and in cable ducts e.g. in industrial and switchboard plants.

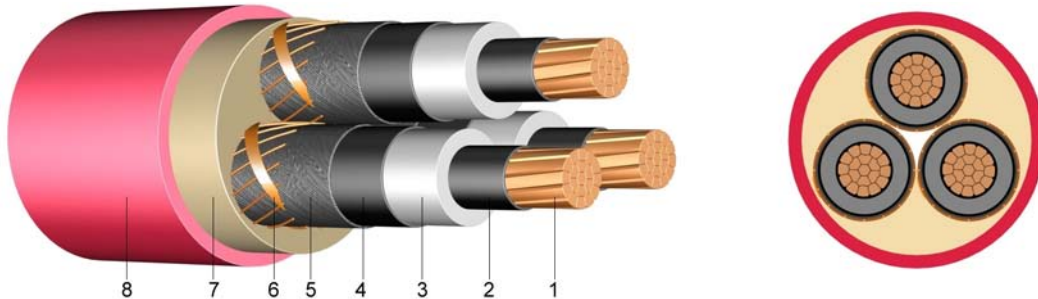

Construction:

- 1 stranded bare copper
- 2 inner layer of semi-conducting material
- 3 core insulation of cross-linked polyethylene
- 4 outer layer of semi-conducting material
- 5 semi-conducting tape
- 6 screen of copper wires
- 7 inner covering over laid-up cores
- 8 outer sheath of polyvinylchloride (PVC), red

Information:

short circuit temperature (max. 5 sec.)
 $\leq 300\text{mm}^2 \rightarrow 160^\circ\text{C}$
 $> 300\text{mm}^2 \rightarrow 140^\circ\text{C}$

Standards:

DIN VDE 0276-620
 HD 620 S1: 1996
 IEC 60502
 DIN EN 60228 class 2 (construction)

Technical data:

Nominal voltage U_0/U		[V]	6000 / 10000 Volt
Test voltage		[V] _{ac}	21000
Temperature range	in motion		- 5°C till +70°C
	fixed		-20°C till +70°C
Operating temperature	short circuit	°C	250
Short circuit time	max.	[sec]	5
Bending radius	min.	x diameter	15
Flammability	standard		EN 60332-1-2

Number of cores and nominal cross section	Price	Copper figure	Overall diameter	Weight	Current carrying capacity ground	Current carrying capacity air
mm ²	EUR / km	kg/km	appr. mm	appr. kg / km	A	A
3 x 35 RM/16	26.079,99	1.260	49	2.600	213	213
3 x 50 RM/16	30.986,11	1.690	51	2.900	220	236
3 x 70 RM/16	38.051,47	2.290	55	3.350	261	265
3 x 95 RM/16	48.402,10	3.119	58	4.200	312	322
3 x 120 RM/16	56.469,52	3.790	62	5.050	355	370
3 x 150 RM/25	65.518,14	4.795	66	6.000	399	420
3 x 185 RM/25	74.846,04	5.845	69	7.200	451	481
3 x 240 RM/25	90.542,70	7.495	75	9.000	523	566

N2XS_Y

XLPE Insulated Single-Core Cable with PVC Outer Sheath

Application:

To be laid directly in ground, outdoors, indoors and in cable ducts.

Puesto directamente en tierra, al aire libre, en sala y en canales de cable

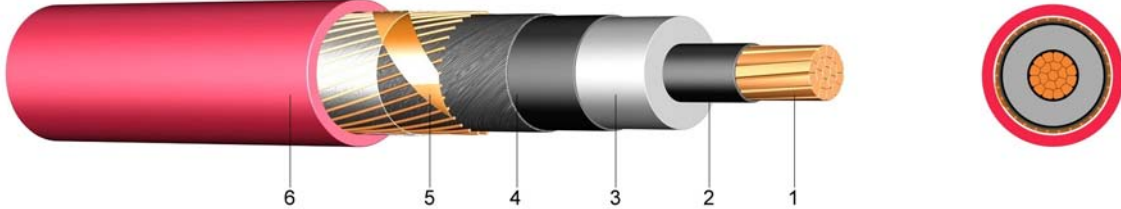

Construction:

- 1 1.-cadena (RM) de cobre desnudo
- 2 2.-capa interior de material semiconductor
- 3 3.-Aislamiento de polietileno reticulado
- 4 4.-capa exterior de material semiconductor
- 5 5.- pantalla de hilos de cobre
- 6 6.- cubierta exterior de cloruro de polivinilo (PVC), rojo

Standards:

DIN VDE 0276-620
HD 620 S1: 1995
DIN EN 60228 class 2 (construction)

6.-cubierta exterior de cloruro de polivinilo (PVC), rojo

Technical data: Datos técnicos

Test voltage	Tensión de prueba	6 / 10 kV	[kV]	21 / 5 min.
		12 / 20 kV	[kV]	42 / 5 min.
		18 / 30 kV	[kV]	63 / 5 min.
Temperature range		in motion		- 5°C till +70°C
		fixed		-20°C till +70°C
Operating temperature		short circuit	°C	250
Short circuit time		max.	[sec]	5
Bending radius		min.	x diameter	15
Flammability	cobre figura	standard		EN 60332-1-2

Número de núcleos y transversal nominal sección

Number of cores and nominal cross section mm ²	Price Precio EUR / km	Copper figure kg/km	Overall diameter appr. mm	Overall diameter max. value appr. mm	Weight appr. kg / km	Current carrying capacity ground A*	Current carrying capacity air A*
6 / 10 kV							
1 x 35 RM/16	10.201,24	540	23	28	900	187	197
1 x 50 RM/16	11.166,85	690	24	29	1.050	220	236
1 x 70 RM/16	13.001,04	890	26	31	1.300	268	294
1 x 95 RM/16	15.367,15	1.140	27	32	1.600	320	358
1 x 120 RM/16	18.232,85	1.390	29	34	1.850	363	413
1 x 150 RM/25	21.426,80	1.795	30	35	2.200	405	468
1 x 185 RM/25	24.853,17	2.145	32	37	2.600	456	535
1 x 240 RM/25	30.028,67	2.695	34	39	3.150	526	631
1 x 300 RM/25	35.555,19	3.295	36	40	3.750	591	722
1 x 400 RM/35	48.217,18	4.410	40	45	4.650	662	827
1 x 500 RM/35	54.682,96	5.410	43	47	5.750	739	921

general de diámetro

Peso actual llevar capacidad suelo

Number of cores and nominal cross section mm ²	Price EUR / km	Copper figure kg/km	Overall diameter appr. mm	Overall diameter max. value appr. mm	Weight appr. kg / km	Current carrying capacity ground A*	Current carrying capacity air A*
12 / 20 kV							
1 x 35 RM/16	13.397,58	540	27	32	1.100	189	200
1 x 50 RM/16	14.480,60	690	28	33	1.250	222	239
1 x 70 RM/16	16.410,64	890	30	35	1.450	271	297
1 x 95 RM/16	18.934,90	1.140	31	36	1.750	323	361
1 x 120 RM/16	21.854,49	1.390	33	38	2.050	367	416
1 x 150 RM/25	24.951,40	1.795	34	39	2.400	409	470
1 x 185 RM/25	28.533,52	2.145	36	41	2.800	461	538
1 x 240 RM/25	32.425,92	2.695	39	44	3.400	532	634
1 x 300 RM/25	36.942,50	3.295	41	46	4.000	599	724
1 x 400 RM/35	43.737,74	4.410	44	49	4.950	671	829
1 x 500 RM/35	57.916,44	5.410	47	52	6.050	754	953

Number of cores and nominal cross section mm ²	Price EUR / km	Copper figure kg/km	Overall diameter appr. mm	Overall diameter max. value appr. mm	Weight appr. kg / km	Current carrying capacity ground A*	Current carrying capacity air A*
18 / 30 kV							
1 x 50 RM/16	17.629,03	690	33	38	1.450	225	241
1 x 70 RM/16	20.637,30	890	35	40	1.700	274	299
1 x 95 RM/16	22.713,49	1.140	36	41	2.050	327	363
1 x 120 RM/16	25.010,10	1.390	38	43	2.300	371	418
1 x 150 RM/25	29.674,04	1.795	39	44	2.700	414	472
1 x 185 RM/25	33.174,70	2.145	41	46	3.100	466	539
1 x 240 RM/25	38.493,95	2.695	43	48	3.700	539	635
1 x 300 RM/25	41.719,05	3.295	46	51	4.350	606	725
1 x 400 RM/35	48.181,24	4.410	49	54	5.300	680	831
1 x 500 RM/35	64.560,73	5.410	52	57	6.450	765	953

* trefoil touching arrangement

disposición conmovedora trébol

N2XS2Y

XLPE Insulated Single-Core Cable with PE Outer Sheath

Application: To be laid directly in ground, outdoors, indoors and in cable ducts.

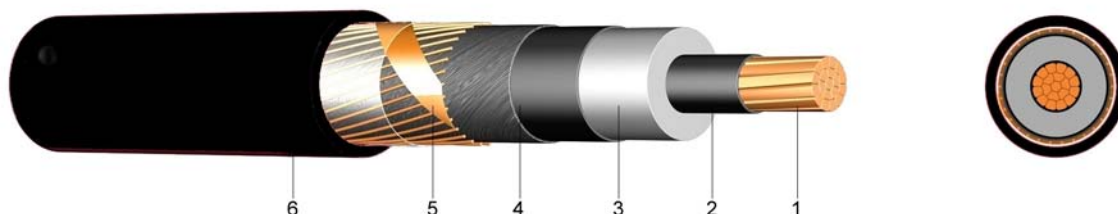

Construction:

- 1 stranded (RM) bare copper
- 2 inner layer of semi-conducting material
- 3 core insulation of cross-linked polyethylene
- 4 outer layer of semi-conducting material
- 5 screen of copper wires
- 6 outer sheath of polyethylene (PE), black

Standards: DIN VDE 0276-620
 HD 620 S1: 1996
 DIN EN 60228 class 2 (construction)

Technical data:

Test voltage	6 / 10 kV	[kV]	21 / 5 min.
	12 / 20 kV	[kV]	42 / 5 min.
	18 / 30 kV	[kV]	63 / 5 min.
Temperature range	in motion		-20°C till +90°C
	fixed		-20°C till +90°C
Operating temperature	short circuit	°C	250
Short circuit time	max.	[sec]	5
Bending radius	min.	x diameter	15
Flammability	standard		EN 60332-1-2

Number of cores and nominal cross section mm ²	Price EUR / km	Copper figure kg/km	Overall diameter appr. mm	Overall diameter max. value appr. mm	Weight appr. kg / km	Current carrying capacity ground A*	Current carrying capacity air A*
6 / 10 kV							
1 x 35 RM/16	10.201,24	540	23	28	820	187	197
1 x 50 RM/16	11.166,85	690	24	29	960	220	236
1 x 70 RM/16	13.001,04	890	26	31	1.150	269	292
1 x 95 RM/16	15.367,15	1.140	27	32	1.450	320	358
1 x 120 RM/16	18.232,85	1.390	29	34	1.700	363	413
1 x 150 RM/25	21.426,80	1.795	30	35	2.000	405	468
1 x 185 RM/25	24.853,17	2.145	32	37	2.350	456	535
1 x 240 RM/25	30.028,67	2.695	34	39	2.900	526	631
1 x 300 RM/25	35.555,19	3.295	36	41	3.550	591	722
1 x 400 RM/35	48.217,18	4.410	40	45	4.500	662	827
1 x 500 RM/35	54.682,94	5.410	43	48	5.550	744	949

Number of cores and nominal cross section mm ²	Price EUR / km	Copper figure kg/km	Overall diameter appr. mm	Overall diameter	Weight appr. kg / km	Current carrying capacity ground A*	Current carrying capacity air A*
				max. value appr. mm			
12 / 20 kV							
1 x 35 RM/16	13.397,58	540	27	32	1.000	189	200
1 x 50 RM/16	14.480,60	690	28	33	1.150	222	239
1 x 70 RM/16	16.410,64	890	30	35	1.350	271	297
1 x 95 RM/16	18.934,90	1.140	31	36	1.600	323	361
1 x 120 RM/16	21.854,49	1.390	33	38	1.850	367	416
1 x 150 RM/25	24.951,40	1.795	34	39	2.250	409	470
1 x 185 RM/25	28.533,52	2.145	36	41	2.600	461	538
1 x 240 RM/25	32.425,92	2.695	39	44	3.150	532	634
1 x 300 RM/25	36.942,50	3.295	41	46	3.800	599	724
1 x 400 RM/35	43.737,74	4.410	44	49	4.750	671	829
1 x 500 RM/35	57.916,44	5.410	47	52	5.800	754	953

Number of cores and nominal cross section mm ²	Price EUR / km	Copper figure kg/km	Overall diameter appr. mm	Overall diameter	Weight appr. kg / km	Current carrying capacity ground A*	Current carrying capacity air A*
				max. value appr. mm			
18 / 30 kV							
1 x 50 RM/16	17.629,03	690	33	38	1.350	225	241
1 x 70 RM/16	20.637,30	890	35	40	1.600	274	299
1 x 95 RM/16	22.713,49	1.140	36	41	1.900	327	363
1 x 120 RM/16	25.010,10	1.390	38	43	2.200	371	418
1 x 150 RM/25	29.674,04	1.795	39	44	2.550	414	472
1 x 185 RM/25	33.174,70	2.145	41	46	2.950	466	539
1 x 240 RM/25	38.493,95	2.695	43	48	3.500	539	635
1 x 300 RM/25	41.719,05	3.295	46	51	4.150	606	725
1 x 400 RM/35	48.181,24	4.410	49	54	5.150	680	831
1 x 500 RM/35	64.560,73	5.410	52	57	6.200	765	953

* trefoil touching arrangement

N2XS(F)2Y

Single-Core XLPE Insulated Cable with PE Outer Sheath, longitudinally watertight

Application: To be laid directly in ground, in water, outdoors, indoors and in cable ducts.

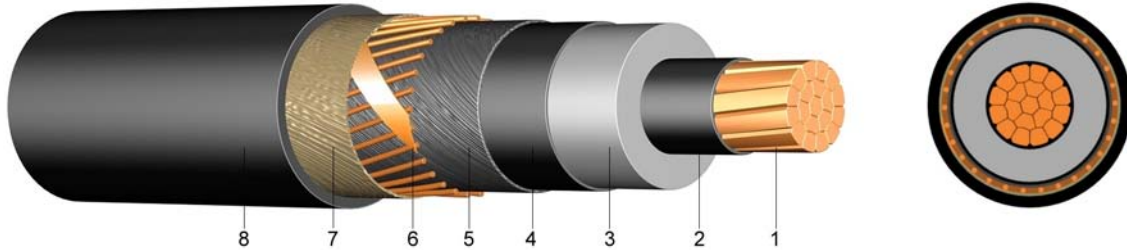

Construction:

- 1 stranded (RM) bare copper wire
- 2 inner layer of semi-conducting material
- 3 core insulation of cross-linked polyethylene
- 4 outer layer of semi-conducting material
- 5 swellable tape
- 6 screen of copper wires
- 7 anti-twist tape
- 8 outer sheath of polyethylene (PE), black

Standards: DIN VDE 0276-620
 HD 620 S1 : 1995
 DIN EN 60228 class 2 (construction)

Technical data:

Test voltage	6 / 10 kV	[kV]	21 / 5 min.
	12 / 20 kV	[kV]	42 / 5 min.
	18 / 30 kV	[kV]	63 / 5 min.
Temperature range	in motion		-20°C till +90°C
	fixed		-20°C till +90°C
Operating temperature	short circuit	°C	250
Short circuit time	max.	[sec]	5
Bending radius	min.	x diameter	15
Flammability	standard		EN 60332-1-2

Number of cores and nominal cross section mm ²	Price	Copper figure	Overall diameter	Overall diameter	Weight	Current carrying capacity ground	Current carrying capacity air
	EUR / km	kg/km	appr. mm	max. value appr. mm	appr. kg / km	A*	A*
6 / 10 kV							
1 x 35 RM/16	11.256,70	540	23	28	820	187	197
1 x 50 RM/16	12.125,27	690	24	29	960	220	236
1 x 70 RM/16	13.753,40	890	26	31	1.200	268	294
1 x 95 RM/16	15.864,33	1.140	27	32	1.450	320	358
1 x 120 RM/16	18.402,97	1.390	29	34	1.700	363	413
1 x 150 RM/25	21.239,90	1.795	30	35	2.000	405	468
1 x 185 RM/25	24.317,64	2.145	32	37	2.350	456	535
1 x 240 RM/25	28.963,61	2.695	34	39	2.900	526	631
1 x 300 RM/25	33.936,64	3.295	36	41	3.550	591	722
1 x 400 RM/35	42.927,88	4.410	40	45	4.500	662	827
1 x 500 RM/35	53.944,97	5.410	43	48	5.550	744	949

Number of cores and nominal cross section mm ²	Price EUR / km	Copper figure kg/km	Overall diameter appr. mm	Overall diameter max. value appr. mm	Weight appr. kg / km	Current carrying capacity ground A*	Current carrying capacity air A*
12 / 20 kV							
1 x 50 RM/16	17.334,31	690	28	33	1.150	222	239
1 x 70 RM/16	19.330,24	890	30	35	1.350	271	297
1 x 95 RM/16	21.927,56	1.140	31	36	1.600	232	361
1 x 120 RM/16	24.934,63	1.390	33	38	1.850	367	416
1 x 150 RM/25	28.141,77	1.795	34	39	2.250	409	470
1 x 185 RM/25	31.862,85	2.145	36	41	2.600	461	538
1 x 240 RM/25	35.961,32	2.695	39	44	3.150	532	634
1 x 300 RM/25	40.723,50	3.295	41	46	3.800	599	724
1 x 400 RM/35	47.909,29	4.410	44	49	4.750	671	829
1 x 500 RM/25	62.490,53	5.410	47	52	6.450	750	927

Number of cores and nominal cross section mm ²	Price EUR / km	Copper figure kg/km	Overall diameter appr. mm	Overall diameter max. value appr. mm	Weight appr. kg / km	Current carrying capacity ground A*	Current carrying capacity air A*
18 / 30 kV							
1 x 50 RM/16	23.600,02	690	33	38	1.350	225	241
1 x 95 RM/16	26.803,56	1.140	36	41	1.900	327	363
1 x 120 RM/16	30.276,65	1.390	38	43	2.200	371	418
1 x 150 RM/25	33.258,56	1.795	39	44	2.550	414	472
1 x 185 RM/25	36.894,57	2.145	41	46	2.950	466	539
1 x 240 RM/25	41.181,13	2.695	43	48	3.500	539	635
1 x 300 RM/25	45.890,60	3.295	46	51	4.150	606	725
1 x 400 RM/25	52.758,91	4.410	49	54	5.050	680	831
1 x 500 RM/35	69.621,21	5.410	52	57	6.200	765	953

* trefoil touching arrangement

NA2XSJ

XLPE Insulated Single-Core Cable with PVC Outer Sheath

Application: To be laid directly in ground, outdoors, indoors and in cable ducts.

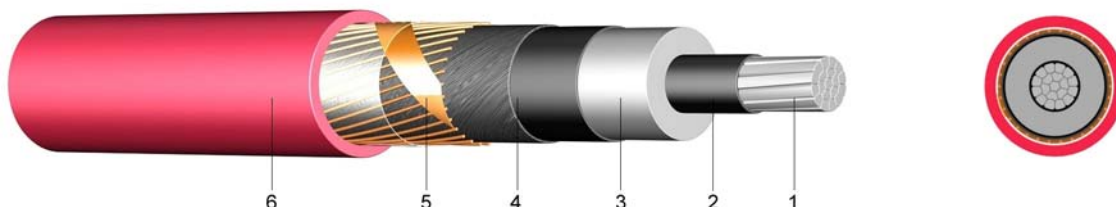

Construction:

- 1 stranded (RM) aluminium wires
- 2 inner layer of semi-conducting material
- 3 core insulation of cross-linked polyethylene
- 4 outer layer of semi-conducting material
- 5 screen of copper wires
- 6 outer sheath of polyvinylchloride (PVC), red

Standards:

DIN VDE0276-620
 HD 620 S1: 1995
 DIN EN 60228 class 2 (construction)

Technical data:

Test voltage	6 / 10 kV	[kV]	21 / 5 min.
	12 / 20 kV	[kV]	42 / 5 min.
	18 / 30 kV	[kV]	63 / 5 min.
Temperature range	in motion		- 5°C till +70°C
	fixed		-20°C till +70°C
Operating temperature	short circuit	°C	250
Short circuit time	max.	[sec]	5
Bending radius	min.	x diameter	15
Flammability	standard		EN 60332-1-2

Number of cores and nominal cross section mm ²	Price EUR / km	Aluminium figure kg/km	Copper figure kg/km	Overall diameter appr. mm	Overall diameter max. value appr. mm	Weight appr. kg / km	Current carrying capacity ground A*	Current carrying capacity air A*
6 / 10 kV								
1 x 35 RM/16	9.329,07	103	190	23	28	700	145	153
1 x 50 RM/16	10.126,97	147	190	24	29	750	171	183
1 x 70 RM/16	11.420,84	206	190	26	31	850	208	228
1 x 95 RM/16	12.954,31	279	190	27	32	950	248	278
1 x 120 RM/16	13.739,02	353	190	29	34	1.050	283	321
1 x 150 RM/25	15.537,27	441	295	30	35	1.300	315	364
1 x 185 RM/25	17.520,02	544	295	32	37	1.400	357	418
1 x 240 RM/25	19.523,12	706	295	34	39	1.650	413	494
1 x 300 RM/25	22.407,99	882	295	36	40	1.850	466	568
1 x 400 RM/35	28.479,61	1.176	410	40	45	2.300	529	660

Number of cores and nominal cross section mm ²	Price EUR / km	Aluminium figure kg/km	Copper figure kg/km	Overall diameter appr. mm	Overall diameter max. value appr. mm	Weight appr. kg / km	Current carrying capacity ground A*	Current carrying capacity air A*
12 / 20 kV								
1 x 50 RM/16	12.483,49	147	190	28	33	950	172	185
1 x 70 RM/16	13.995,40	206	190	30	35	1.050	210	231
1 x 95 RM/16	15.292,88	279	190	31	36	1.150	251	280
1 x 120 RM/16	16.427,42	353	190	33	38	1.300	285	323
1 x 150 RM/25	18.268,78	441	295	34	39	1.500	319	366
1 x 185 RM/25	21.443,57	544	295	36	41	1.650	361	420
1 x 240 RM/25	22.719,48	706	295	39	44	1.850	417	496
1 x 300 RM/25	26.163,81	882	295	41	46	2.100	471	569
1 x 400 RM/35	33.404,71	1.176	410	44	49	2.550	535	660

Number of cores and nominal cross section mm ²	Price EUR / km	Aluminium figure kg/km	Copper figure kg/km	Overall diameter appr. mm	Overall diameter max. value appr. mm	Weight appr. kg / km	Current carrying capacity ground A*	Current carrying capacity air A*
18 / 30 kV								
1 x 50 RM/16	17.764,41	147	190	36	41	1.190	175	187
1 x 70 RM/16	18.552,72	206	190	37	42	1.315	214	232
1 x 95 RM/16	19.889,71	279	190	39	43	1.450	256	281
1 x 120 RM/16	21.541,80	353	190	40	45	1.580	290	323
1 x 150 RM/25	23.431,11	441	295	42	47	1.800	324	365
1 x 185 RM/25	25.339,57	544	295	44	49	1.965	366	418
1 x 240 RM/25	28.030,35	706	295	46	51	2.230	426	494
1 x 300 RM/25	30.555,80	882	295	49	53	2.470	479	564
1 x 400 RM/35	33.984,57	1.176	410	51	56	2.920	545	654

* trefoil touching arrangement

NA2XS2Y

XLPE Insulated Single-Core Cable with PE Outer Sheath

Application: To be laid directly in ground, outdoors, indoors and in cable ducts.

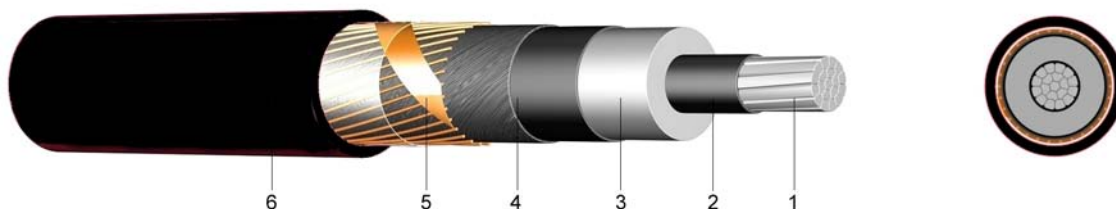

Construction:

- 1 stranded (RM) aluminium wires
- 2 inner layer of semi-conducting material
- 3 core insulation of cross-linked polyethylene
- 4 outer layer of semi-conducting material
- 5 screen of copper wires
- 6 outer sheath of polyethylene (PE), black

Standards: DIN VDE 0276-620
HD 620 S1: 1995
DIN EN 60228 class 2 (construction)

Technical data:

Test voltage	6 / 10 kV	[kV]	21 / 5 min.
	12 / 20 kV	[kV]	42 / 5 min.
	18 / 30 kV	[kV]	63 / 5 min.
Temperature range	in motion		-20°C till +70°C
	fixed		-20°C till +70°C
Operating temperature	short circuit	°C	250
Short circuit time	max.	[sec]	5
Bending radius	min.	x diameter	15
Flammability	standard		EN 60332-1-2

Number of cores and nominal cross section mm ²	Price EUR / km	Aluminium figure kg/km	Copper figure kg/km	Overall diameter appr. mm	Overall diameter max. value appr. mm	Weight appr. kg / km	Current carrying capacity ground A*	Current carrying capacity air A*
6 / 10 kV								
1 x 35 RM/16	9.329,07	103	190	23	28	600	145	153
1 x 50 RM/16	10.126,97	147	190	24	29	670	171	183
1 x 70 RM/16	11.420,84	206	190	26	31	770	208	228
1 x 95 RM/16	12.954,31	279	190	27	32	880	248	278
1 x 120 RM/16	13.739,02	353	190	29	34	950	283	321
1 x 150 RM/25	15.537,27	441	295	30	35	1.150	315	364
1 x 185 RM/25	17.520,02	544	295	32	37	1.250	357	418
1 x 240 RM/25	19.523,12	706	295	34	39	1.500	413	494
1 x 300 RM/25	22.407,99	882	295	36	41	1.700	466	568
1 x 400 RM/35	28.479,61	1.176	410	40	45	2.100	529	660

Number of cores and nominal cross section mm ²	Price EUR / km	Aluminium figure kg/km	Copper figure kg/km	Overall diameter appr. mm	Overall diameter max. value appr. mm	Weight appr. kg / km	Current carrying capacity ground A*	Current carrying capacity air A*
12 / 20 kV								
1 x 50 RM/16	12.483,49	147	190	28	33	820	172	185
1 x 70 RM/16	13.995,40	206	190	30	35	930	210	231
1 x 95 RM/16	15.292,88	279	190	31	36	1.050	251	280
1 x 120 RM/16	16.427,42	353	190	33	38	1.150	285	323
1 x 150 RM/25	18.268,78	441	295	34	39	1.350	319	366
1 x 185 RM/25	21.443,57	544	295	36	41	1.500	361	420
1 x 240 RM/25	22.719,48	706	295	39	44	1.750	417	496
1 x 300 RM/25	26.163,81	882	295	41	46	2.000	471	569
1 x 400 RM/35	33.404,71	1.176	410	44	49	2.350	535	660

Number of cores and nominal cross section mm ²	Price EUR / km	Aluminium figure kg/km	Copper figure kg/km	Overall diameter appr. mm	Overall diameter max. value appr. mm	Weight appr. kg / km	Current carrying capacity ground A*	Current carrying capacity air A*
18 / 30 kV								
1 x 50 RM/16	17.764,41	147	190	33	38	1.100	174	187
1 x 70 RM/16	18.552,72	206	190	35	40	1.200	213	232
1 x 95 RM/16	19.889,71	279	190	36	41	1.350	254	282
1 x 120 RM/16	21.541,80	353	190	38	43	1.450	289	325
1 x 150 RM/25	23.431,11	441	295	39	44	1.700	322	367
1 x 185 RM/25	25.339,57	544	295	41	46	1.850	364	421
1 x 240 RM/25	28.030,35	706	295	43	48	2.050	422	496
1 x 300 RM/25	30.555,80	882	295	46	51	2.350	476	568
1 x 400 RM/35	33.984,57	1.176	410	49	54	2.800	541	650

* trefoil touching arrangement

NA2XS(F)2Y Single-Core XLPE Insulated Cable with PE Outer Sheath, longitudinally watertight

Application: To be laid directly in ground, outdoors, in water, indoors and in cable ducts.

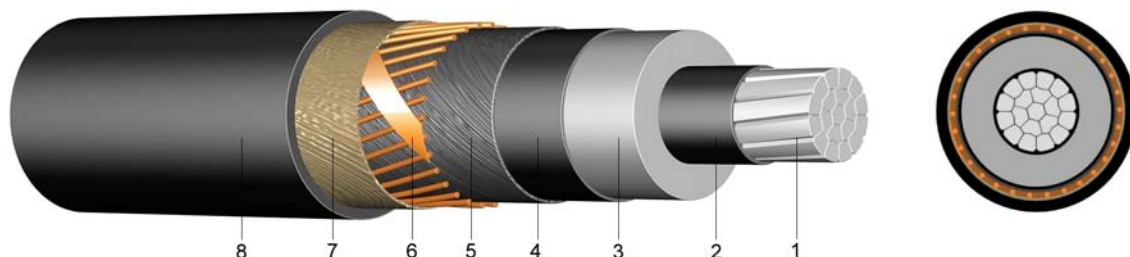

- Construction:**
- 1 stranded (RM) aluminium wire
 - 2 inner layer of semi-conducting material
 - 3 core insulation of cross-linked polyethylene
 - 4 outer layer of semi-conducting material
 - 5 swellable tape
 - 6 screen of copper wires
 - 7 anti-twist tape
 - 8 outer sheath of polyethylene (PE), black

Standards: DIN VDE 0276-620
 HD 620 S1: 1995
 DIN EN 60228 class 2 (construction)

Technical data:

Test voltage	6 / 10 kV	[kV]	21 / 5 min.
	12 / 20 kV	[kV]	42 / 5 min.
	18 / 30 kV	[kV]	63 / 5 min.
Temperature range	in motion		-20°C till +70°C
	fixed		-20°C till +70°C
Operating temperature	short circuit	°C	250
Short circuit time	max.	[sec]	5
Bending radius	min.	x diameter	15
Flammability	standard		EN 60332-1-2

Number of cores and nominal cross section mm ²	Price EUR / km	Aluminium figure kg/km	Copper figure kg/km	Overall diameter appr. mm	Overall diameter max. value appr. mm	Weight appr. kg / km	Current carrying capacity ground A*	Current carrying capacity air A*
6 / 10 kV								
1 x 50 RM/16	11.623,30	147	190	24	29	670	171	183
1 x 70 RM/16	12.841,70	206	190	26	31	770	209	226
1 x 95 RM/16	15.728,95	279	190	27	32	880	248	278
1 x 120 RM/16	16.686,19	353	190	29	34	950	283	321
1 x 150 RM/25	18.594,65	441	295	30	35	1.150	315	364
1 x 185 RM/25	19.744,76	544	295	32	37	1.250	357	418
1 x 240 RM/25	22.718,26	706	295	34	39	1.500	413	494
1 x 300 RM/25	27.129,43	882	295	36	41	1.700	466	568
1 x 400 RM/35	32.277,37	1.176	410	40	45	2.100	529	660
1 x 500 RM/35	42.000,55	1.479	410	43	48	2.450	602	767

Number of cores and nominal cross section mm ²	Price EUR / km	Aluminium figure kg/km	Copper figure kg/km	Overall diameter appr. mm	Overall diameter max. value appr. mm	Weight appr. kg / km	Current carrying capacity ground A*	Current carrying capacity air A*
12 / 20 kV								
1 x 50 RM/16	15.693,02	147	190	28	33	820	172	185
1 x 70 RM/16	16.687,38	206	190	30	35	930	210	231
1 x 95 RM/16	18.981,61	279	190	31	36	1.050	251	280
1 x 120 RM/16	20.621,72	353	190	33	38	1.150	285	323
1 x 150 RM/25	22.683,53	441	295	34	39	1.350	319	366
1 x 185 RM/25	24.602,77	544	295	36	41	1.500	361	420
1 x 240 RM/25	27.602,65	706	295	39	44	1.750	417	496
1 x 300 RM/25	31.405,20	882	295	41	46	2.000	471	569
1 x 400 RM/35	37.537,92	1.176	410	44	49	2.350	535	660
1 x 500 RM/35	52.657,69	1.470	410	47	52	2.800	609	766

Number of cores and nominal cross section mm ²	Price EUR / km	Aluminium figure kg/km	Copper figure kg/km	Overall diameter appr. mm	Overall diameter max. value appr. mm	Weight appr. kg / km	Current carrying capacity ground A*	Current carrying capacity air A*
18 / 30 kV								
1 x 50 RM/16	19.943,64	147	190	33	38	1.100	174	187
1 x 70 RM/16	20.763,09	206	190	35	40	1.200	213	232
1 x 95 RM/16	23.251,40	279	190	36	41	1.350	254	282
1 x 120 RM/16	23.854,01	353	190	38	43	1.450	289	325
1 x 150 RM/25	26.980,87	441	295	39	44	1.700	322	367
1 x 185 RM/25	29.321,83	544	295	41	46	1.850	364	421
1 x 240 RM/25	31.923,95	706	295	43	48	2.050	422	496
1 x 300 RM/25	36.422,56	882	295	46	51	2.350	476	568
1 x 400 RM/35	43.530,08	1.176	410	49	54	2.800	541	650

* trefoil touching arrangement

H07Z-U

Halogen-Free Single Core Wire

Application:

For the internal wiring of switching systems, equipment and lights as well as for domestic installations, however, not for outdoor use.



Construction:

- 1 solid bare copper
- 2 core insulation of halogen-free, cross-linked polyolefin copolymerisate (EI5)

Standards:

DIN VDE 0282-9
HD 22.9 S2+A1
DIN EN 60228 class 1 (construction)

Technical data:

Nominal voltage U _o /U		[V]	450 / 750 Volt
Test voltage		[V] _{ac}	2500
Temperature range	in motion		+5°C till +90°C
Operating temperature	short circuit	°C	250
Short circuit time	max.	[sec]	5
Bending radius	one time / fixed	x diameter	6
Flammability	standard		EN 60332-1 IEC 60332-1

Nominal cross section mm ²	Colours	Price	Copper figure kg/km	Overall diameter appr.mm	Calorific potential kWh / m	Weight appr. kg / km
		EUR / km				
1,5	bk/bl/br	513,42	15	2,8	0,37	19
	yg	564,78	15	2,8	0,37	19
2,5	bk/bl	625,51	25	3,4	0,44	31
	yg	688,06	25	3,4	0,44	31

H05Z-K

Halogen-Free Single Core Wire

Application:

For fixed installations in devices and in or on lights, as well as for the house installation, especially for uses by their one low creation is demanded of smoke and corrosive gases in the fire case, however not outside.



Construction:

- 1 fine-stranded bare copper
- 2 core insulation of halogen-free, cross-linked polyolefin copolymerisate (E15)

Standards:

DIN VDE 0282-9
 HD 22.9 S2+A1
 DIN EN 60228 class 5 (construction)

Technical data:

Nominal voltage U ₀ /U		[V]	300 / 500 Volt
Test voltage		[V] _{AC}	2000
Temperature range	in motion		+5°C till +90°C
Operating temperature	short circuit	°C	250
Short circuit time	max.	[sec]	5
Bending radius	one time / fixed	x diameter	6
Flammability	standard		EN 60332-1 IEC 60332-1

Nominal cross section mm ²	Colours	Price EUR / km	Copper figure kg/km	Overall diameter appr. mm	Calorific potential kWh / m	Weight appr. kg / km
0,5	bk/bl/br	416,37	5,0	2,2	0,23	9
	yg	411,64	5,0	2,2	0,23	9
0,75	bk/dbl/bl/br	453,09	7,5	2,4	0,26	12
	yg/gr/or/rd	498,38	7,5	2,4	0,26	12
1	bk/bl/br	483,73	10,0	2,5	0,29	15
	yg/wt/or/rd	532,02	10,0	2,5	0,29	15

H07Z-K

Halogen-Free Single Core Wire

Application:

For the installation in electrical conduit on or under plaster or in similar closed systems especially for applications where there is a requirement for low smoke and corrosive gas creation in the event of fire, however not outside.

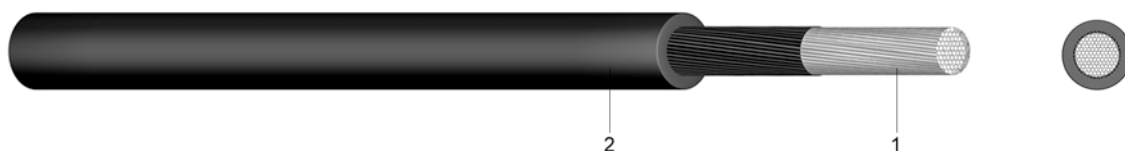

Construction:

- 1 fine-stranded tinned or bare copper
- 2 core insulation of halogen-free, cross-linked polyolefin copolymerisate (E15)

Standards:

DIN VDE 0282-9
 HD 22.9 S2+A1
 DIN EN 60228 class 5 (construction)

Technical data:

Nominal voltage U ₀ /U	[V]	450 / 750 Volt
Test voltage	[V] _{AC}	2500
Temperature range	fixed	+5°C till +90°C
Operating temperature	short circuit	250
Short circuit time	max.	[sec]
Bending radius	one time / fixed	x diameter
Flammability	standard	EN 60332-1 IEC 60332-1

Nominal cross section mm ²	Colours	Price EUR / km	Copper figure kg/km	Overall diameter appr.mm	Calorific potential kWh / m	Weight appr. kg / km
1,5	bk/bl/br	529,62	15	2,9	0,40	20
	yg/gr/wt/or/rd	582,62	15	2,9	0,40	20
2,5	bk/bl/lbl/br	735,29	25	3,6	0,49	32
	yg/gr/rd	808,91	25	3,6	0,49	32
4	bk/bl/br	1.025,01	40	4,1	0,59	46
	yg/gr/rd	1.127,65	40	4,1	0,59	46
6	bk/bl/br	1.337,47	60	4,8	0,71	65
	yg/gr/rd	1.471,24	60	4,8	0,71	65
10	bk/bl	1.904,86	100	6,3	0,89	111
	yg	2.095,41	100	6,3	0,89	111
16	bk/bl/br	2.383,68	160	7,2	1,20	166
	yg	2.622,12	160	7,2	1,20	166
25	bk/bl/br	3.690,01	250	9,0	1,80	255
	yg	4.047,39	250	9,0	1,80	255
35	bk/bl	4.551,36	350	10,1	2,20	348
	yg	5.005,22	350	10,1	2,20	348
50	bk/bl	6.148,19	500	12,0	2,90	501
	yg	6.762,95	500	12,0	2,90	501
70	bk	8.349,71	700	13,6	3,70	685
	yg	9.184,72	700	13,6	3,70	685
95	bk	10.637,59	950	15,6	4,30	902
	yg	11.701,40	950	15,6	4,30	902

NHXMH

Halogen-Free Sheathed Wire with Improved Fire Behaviour

Application:

To be installed in buildings or industrial plants where many people and goods are concentrated. As they don't develop corrosive and halogen gases under the impact of fire, and the smoke and fume generation is also minimal, the damage caused is much smaller. They are destined for the installation on, in and under the wall-surface in dry, humid and wet locations as well as in brickwork or outdoors (when protected), but not directly into the earth.

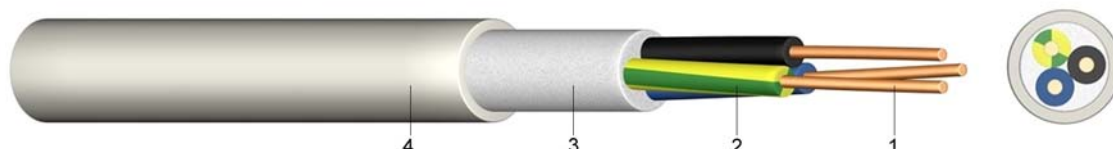

Construction:

- 1 solid or stranded bare copper
- 2 core insulation of cross-linked polyethylene (2X11)
- 3 core covering of a halogen-free filling compound
- 4 outer sheath of halogen-free polymer (HM2), grey

Standards:

DIN VDE 0250-214
 DIN EN 60228 class 1 and 2 (construction)
 HD 308 S2 (core identification)

Technical data:

Nominal voltage U ₀ /U		[V]	300 / 500 Volt
Test voltage		[V] _{Ac}	2000
Temperature range	in motion		-5°C till +70°C
Operating temperature	short circuit	°C	160
Short circuit time	max.	[sec]	5
Bending radius	in motion	x diameter	12
Flammability	standard		EN 50266-2-4 EN 60332-1 IEC 60332-3 Kat.C

Number of cores and nominal cross section mm ²	Price EUR / km J	Price EUR / km O	Copper figure kg/km	Cond. construction (appr. value) mm	Overall diameter appr. mm	Calorific potential kWh / m	Weight appr. kg / km
2 x 1,5		1.828,91	30	1 x 1,38	8,7	0,39	113
2 x 2,5		2.287,47	50	1 x 1,38	9,5	0,45	145
3 x 1,5	2.018,97		45	1 x 1,38	9,1	0,43	130
3 x 2,5	2.541,64		75	1 x 1,78	9,9	0,50	168
3 x 4	3.306,92		120	1 x 2,25	11,2	0,63	234
3 x 6	4.639,26		180	1 x 2,76	12,7	0,79	319
3 x 10	5.028,12		300	1 x 3,56	15,3	1,09	494
4 x 1,5	2.482,28		60	1 x 1,38	9,7	0,50	152
4 x 2,5	3.127,63		100	1 x 1,78	10,6	0,58	201
4 x 4	3.877,85		160	1 x 2,25	12,5	0,83	296
4 x 6	4.904,61		240	1 x 2,76	13,7	0,92	388
4 x 10	7.262,32		400	1 x 3,56	16,5	1,29	606
4 x 16 RM	12.474,08		640	7 x 1,70	19,4	1,68	917
5 x 1,5	3.054,19		75	1 x 1,38	10,4	0,59	177
5 x 2,5	3.915,25		125	1 x 1,78	11,5	0,69	241
5 x 4	4.989,22		200	1 x 2,25	13,5	0,96	352
5 x 6	6.167,67		300	1 x 2,76	15,3	1,16	485

Number of cores and nominal cross section mm²	Price EUR / km J	Price EUR / km O	Copper figure kg/km	Cond. construction (appr. value) mm	Overall diameter appr. mm	Calorific potential kWh / m	Weight appr. kg / km
5 x 10	8.380,21		500	1 x 3,56	18,0	1,56	731
5 x 16 RM	16.108,42		800	7 x 1,70	22,2	2,23	1.168
7 x 1,5	3.561,54		105	1 x 1,38	11,1	0,65	220
7 x 2,5	4.565,67		175	1 x 1,78	12,7	0,82	311
12 x 1,5	5.078,18		180	1 x 1,38	14,8	1,11	391

HSLH FRNC Halogen-Free Control Cable with Improved Fire Behaviour - FRNC

Application: For installations in dry, humid and wet locations, but not outdoors. These cables are used for fix or for flexible applications - but not with high tensile load or for forced bending.

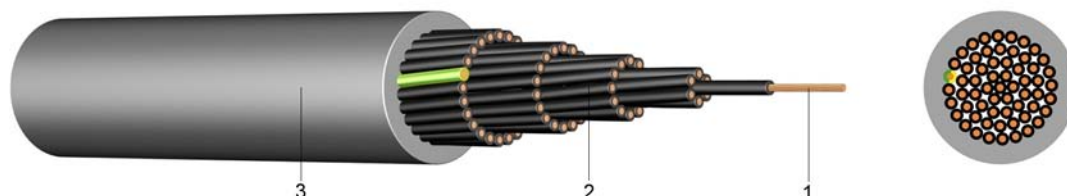

Construction:

- 1 fine-stranded bare copper
- 2 core insulation of halogen-free, cross-linked polyolefin copolymer
- 3 outer sheath of halogen-free, cross-linked polyolefin copolymer, grey

Standards:

- adapted to DIN EN 50266-2-4
- adapted to DIN EN 50267-2-2
- adapted to DIN EN 50268-2
- DIN EN 60228 class 5 (construction)
- core identification JZ: 1 core green/yellow, other cores black with figures
- core identification OZ: every core black with figures

Technical data:

Nominal voltage U ₀ /U		[V]	300 / 500 Volt
Test voltage		[V] _{Ac}	2000
Temperature range	in motion		-15°C till +70°C
Operating temperature	short circuit	°C	150
Short circuit time	max.	[sec]	5
Bending radius	in motion	x diameter	15
Flammability	standard		EN 50266-2-4 EN 60332-1 IEC 60332-3 Kat.C

Number of cores and nominal cross section mm ²	Price EUR / km J	Price EUR / km O	Copper figure kg/km	Cond. construction (appr. value) mm	Overall diameter appr. mm	Weight appr. kg / km
2 x 0,75		1.630,38	15,0	24 x 0,21	5,4	47
3 x 0,75	2.063,76		22,5	24 x 0,21	5,7	56
4 x 0,75	2.132,03		30,0	24 x 0,21	6,2	69
5 x 0,75	2.512,27		37,5	24 x 0,21	6,8	83
7 x 0,75	3.777,29		52,5	24 x 0,21	7,4	104
12 x 0,75	5.123,98		90,0	24 x 0,21	9,9	172
25 x 0,75	10.940,13		187,5	24 x 0,21	14,4	352
2 x 1		1.668,99	20,0	32 x 0,21	5,7	55
3 x 1	2.054,11		30,0	32 x 0,21	6,0	67
4 x 1	2.492,49		40,0	32 x 0,21	6,6	83
5 x 1	2.853,07		50,0	32 x 0,21	7,2	100
7 x 1	3.959,78		70,0	32 x 0,21	8,0	130
12 x 1	5.923,98		120,0	32 x 0,21	10,6	212
18 x 1	8.823,32		180,0	32 x 0,21	12,7	314
25 x 1	12.168,17		250,0	32 x 0,21	15,3	429

Number of cores and nominal cross section mm²	Price EUR / km J	Price EUR / km O	Copper figure kg/km	Cond. construction (appr. value) mm	Overall diameter appr. mm	Weight appr. kg / km
2 x 1,5		2.021,19	30,0	30 x 0,26	6,3	72
3 x 1,5	2.375,83		45,0	30 x 0,26	6,7	88
4 x 1,5	2.867,60		60,0	30 x 0,26	7,3	110
5 x 1,5	3.657,83		75,0	30 x 0,26	8,1	135
7 x 1,5	5.054,65		105,0	30 x 0,26	8,9	174
12 x 1,5	8.109,29		180,0	30 x 0,26	12,0	289
18 x 1,5	11.876,10		270,0	30 x 0,26	14,4	433
25 x 1,5	16.103,87		375,0	30 x 0,26	17,4	596
34 x 1,5	22.304,20		510,0	30 x 0,26	19,6	786
2 x 2,5		2.873,54	50,0	50 x 0,26	7,6	110
3 x 2,5	3.497,79		75,0	50 x 0,26	8,1	137
4 x 2,5	4.753,98		100,0	50 x 0,26	8,9	174
5 x 2,5	5.464,43		125,0	50 x 0,26	10,0	217
12 x 2,5	11.935,08		300,0	50 x 0,26	14,9	467
4 x 4	7.810,35		160,0	56 x 0,31	10,8	267
5 x 4	9.659,85		200,0	56 x 0,31	12,1	331
4 x 6	11.270,10		240,0	84 x 0,31	13,0	388
5 x 6	13.584,87		300,0	84 x 0,31	14,5	480
5 x 10	23.187,85		500,0	80 x 0,41	18,1	766

HSLCH FRNC Halogen-Free Control Cable with EMV-Optimised Braided Screen and Improved Fire Behaviour - FRNC

Application:

For installations in dry, humid and wet locations but not outdoors. These cables are used for fix or for flexible applications - but not with high tensile load and for forced bending. Suitable as a signal and impulse cable in the control, measuring and signal technology. The copper braiding optimises protection against external interferences, like electromagnetic fields and stray frequencies.

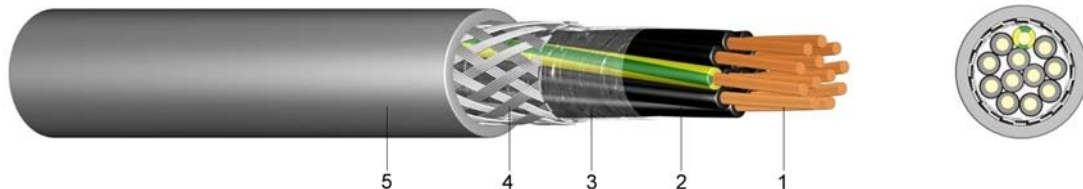

Construction:

- 1 fine-stranded bare copper
- 2 core insulation of halogen-free, cross-linked polyolefin copolymer
- 3 wrapped in a plastic foil
- 4 screen of tinned copper wire braiding
- 5 outer sheath of halogen-free, cross-linked polyolefin copolymer, grey

Standards:

adapted to DIN EN 50266-2-4
 adapted to DIN EN 50267-2-2
 DIN EN 60228 class 5 (construction)
 core identification JZ: 1 core green/yellow, other cores black with figures
 core identification OZ: every core black with figures

Technical data:

Nominal voltage U ₀ /U		[V]	300 / 500 Volt
Test voltage		[V] _{AC}	2000
Temperature range	in motion		-5°C till +70°C
Operating temperature	short circuit	°C	150
Short circuit time	max.	[sec]	5
Bending radius	in motion	x diameter	15
Flammability	standard		EN 50266-2-4 EN 60332-1 IEC 60332-3 Kat.C

Number of cores and nominal cross section mm ²	Price EUR / km J	Price EUR / km O	Copper figure kg/km	Cond. construction (appr. value) mm	Overall diameter appr. mm	Weight appr. kg / km
2 x 0,75		2.969,02	41	24 x 0,21	6,2	55
4 x 0,75	2.969,02		61	24 x 0,21	7,0	87
5 x 0,75	3.618,64		72	24 x 0,21	7,7	106
7 x 0,75	4.888,09		89	24 x 0,21	8,3	129
12 x 0,75	7.530,74		138	24 x 0,21	10,9	211
2 x 1		2.214,74	51	32 x 0,21	6,5	79
3 x 1	2.861,32		62	32 x 0,21	6,8	88
4 x 1	3.455,57		74	32 x 0,21	7,4	106
5 x 1	4.589,50		88	32 x 0,21	8,1	124
7 x 1	5.499,90		112	32 x 0,21	8,8	155

Number of cores and nominal cross section mm ²	Price EUR / km J	Price EUR / km O	Copper figure kg/km	Cond. construction (appr. value) mm	Overall diameter appr. mm	Weight appr. kg / km
12 x 1	8.527,65		185	32 x 0,21	12,3	232
18 x 1	12.459,99		268	32 x 0,21	14,7	332
2 x 1,5		2.992,59	65	30 x 0,26	7,1	91
3 x 1,5	3.533,62		82	30 x 0,26	7,5	112
4 x 1,5	4.480,76		100	30 x 0,26	8,5	141
5 x 1,5	5.330,66		119	30 x 0,26	8,9	161
7 x 1,5	8.262,58		154	30 x 0,26	9,9	206
12 x 1,5	11.450,73		268	30 x 0,26	14,7	323
18 x 1,5	16.550,41		373	30 x 0,26	15,5	517
25 x 1,5	23.521,09		530	30 x 0,26	18,1	705
3 x 2,5	5.292,40		118	50 x 0,26	9,0	157
4 x 2,5	6.661,52		147	50 x 0,26	9,9	201
5 x 2,5	7.640,77		176	50 x 0,26	11,0	248
7 x 2,5	10.085,92		253	50 x 0,26	13,9	306

N2XH

Halogen-Free Cable with Improved Fire Behaviour

Application:

Safety cables are used in all locations where a high degree of protection against fire and fire-damage has to be provided for human life and equipment and are, therefore, subject to high security requirements. These cables may be used indoors and outdoors. They may not be installed directly into the ground and into the water. This cable conforms to Safety Class II standards.

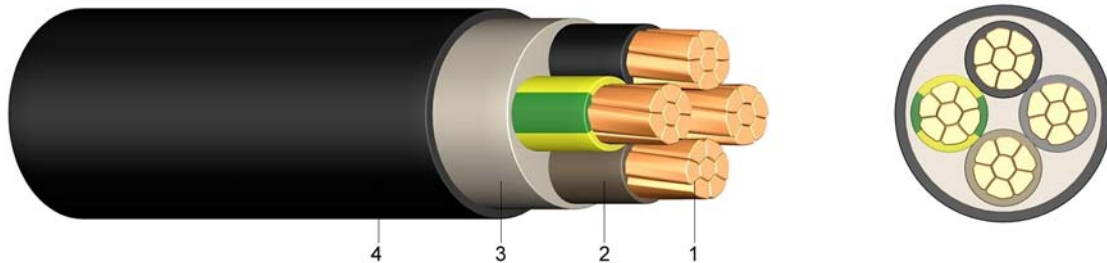

Construction:

- 1 solid or stranded bare copper
- 2 core insulation of halogen-free, cross-linked polyethylene
- 3 core covering of a halogen-free compound
- 4 outer sheath of halogen-free, cross-linked polymer compound, black

Standards:

DIN VDE 0276-604
 HD 604 S1 part 1 + part 5 G
 DIN EN 60228 class 1 and 2 (construction)
 HD 308 S2 (core identification)

Technical data:

Nominal voltage U ₀ /U		[V]	600 / 1000 Volt
Test voltage		[V] _{Ac}	4000
Temperature range	in motion		-5°C till +90°C
Operating temperature	short circuit	°C	250
Short circuit time	max.	[sec]	5
Bending radius	single core style	x diameter	15
	multi core style	x diameter	12
Flammability	standard		EN 50266-2-4 EN 60332-1 IEC 60332-3 Kat.C

Number of cores and nominal cross section mm ²	Price		Copper figure kg/km	Overall diameter appr. mm	Calorific potential kWh / m	Weight appr. kg / km
	EUR / km J	EUR / km O				
1 x 6 RE		2.422,35	60	7,8	0,33	112
1 x 16 RM	3.958,21	3.958,21	160	9,8	0,46	226
1 x 25 RM	5.492,64	5.492,64	250	11,4	0,62	327
1 x 35 RM	6.594,75	6.594,75	350	12,6	0,71	429
1 x 50 RM	8.446,40	8.446,40	500	13,8	0,82	555
1 x 70 RM	10.902,98	10.902,98	700	15,7	1,00	765
1 x 95 RM	13.832,72	13.832,72	950	17,4	1,14	1.024
1 x 120 RM	16.508,04	16.508,04	1.200	19,0	1,32	1.263
1 x 150 RM	20.103,45	20.103,45	1.500	20,9	1,59	1.542
1 x 185 RM	24.259,47	24.259,47	1.850	23,1	1,91	1.918
1 x 240 RM	30.563,92	30.563,92	2.400	25,6	2,24	2.466
1 x 300 RM		37.844,54	3.000	28,1	2,58	3.065

Number of cores and nominal cross section mm ²	Price		Copper figure kg/km	Overall diameter appr. mm	Calorific potential kWh / m	Weight appr. kg / km
	EUR / km J	EUR / km O				
2 x 1,5 RE		3.107,38	30	9,3	0,45	125
2 x 2,5 RE		3.639,90	50	10,1	0,52	158
3 x 1,5 RE	3.150,29		45	9,7	0,51	142
3 x 2,5 RE	3.896,22		75	10,6	0,59	184
3 x 4 RE	4.628,45		120	11,7	0,70	247
3 x 6 RE	5.887,21		180	12,8	0,80	322
3 x 10 RE	7.779,58		300	14,9	1,02	480
3 x 16 RM	10.321,21		480	17,7	1,36	732
3 x 25 RM	15.926,27		750	24,0	2,25	1.200
3 x 35 RM	19.201,34		1.050	27,0	2,56	1.600
3 x 50 RM	22.481,35		1.500	29,0	3,19	1.800
3 x 50/25 SM/RM	28.666,21		1.750	32,0	3,53	2.200
3 x 70/35 SM/RM	36.225,69		2.450	37,0	4,31	2.950
3 x 95/50 SM	45.993,62		3.216	41,0	5,58	3.900
3 x 120/70 RM	56.625,99		4.300	45,0	6,58	4.800
3 x 150/70 RM	67.590,10		5.200	49,0	7,64	5.750
3 x 185/95 RM	83.106,69		6.500	55,0		7.200
3 x 240/120 RM	106.867,33		8.400	62,0		9.150
4 x 1,5 RE	3.638,59		60	10,4	0,60	166
4 x 2,5 RE	4.466,67		100	11,4	0,69	220
4 x 4 RE	5.319,36		160	12,6	0,84	298
4 x 6 RE	6.799,50		240	13,8	0,95	391
4 x 10 RE	9.277,25	9.277,25	400	16,3	1,26	599
4 x 16 RM	12.583,77	12.583,77	640	19,2	1,63	908
4 x 25 RM	20.143,35	20.143,35	1.000	23,9	2,48	1.413
4 x 35 RM	24.172,08	24.172,08	1.400	26,7	2,93	1.863
4 x 50 SM	32.058,40	32.058,40	2.000	29,1	3,76	2.362
4 x 70 SM	42.959,05		2.800	32,2	4,55	3.151
4 x 95 SM	55.011,77	55.011,77	3.800	37,2	5,72	4.339
4 x 120 SM	68.064,27	68.064,27	4.800	40,8	6,36	5.332
4 x 150 SM	82.310,19	82.310,19	6.000	50,0	7,14	6.350
5 x 1,5 RE	4.421,64		75	11,2	0,71	195
5 x 2,5 RE	5.512,12		125	12,3	0,84	260
5 x 4 RE	6.368,37		200	13,7	1,00	357
5 x 6 RE	7.992,82		300	15,4	1,21	486
5 x 10 RE	10.636,87		500	17,8	1,52	723
5 x 16 RE	14.242,19		800	21,6	2,17	1.138
5 x 16 RM	14.242,19		800	21,6	2,17	1.138
5 x 25 RM	24.160,56		1.250	27,0	3,14	1.420
5 x 35 RM	31.038,22		1.750	37,0	3,95	2.400
7 x 1,5 RE	5.313,99		105	12,0	0,80	239
12 x 1,5 RE	7.826,00		180	16,0	1,29	395
19 x 1,5 RE	10.997,72		285	18,6	1,80	557
24 x 1,5 RE	13.015,27		360	22,2	2,35	736
30 x 1,5 RE	15.527,56		450	24,0	2,72	900
7 x 2,5 RE	6.478,47		175	15,0	1,31	400
12 x 2,5 RE	9.795,91		300	19,0	2,00	600
19 x 2,5 RE	14.073,87		475	22,0	2,69	840
24 x 2,5 RE	16.893,03		600	25,0	3,28	1.050
7 x 4 RE	8.440,32		280	14,9	1,48	457

N2XCH

Halogen-Free Cable with Concentric Conductor with Improved Fire Behaviour

Application:

Safety cables are used in all locations where a high degree of protection against fire and fire-damage has to be provided for human life and equipment and are, therefore, subject to high security requirements. These cables may be used indoors and outdoors. They may not be installed directly into the ground and into the water.

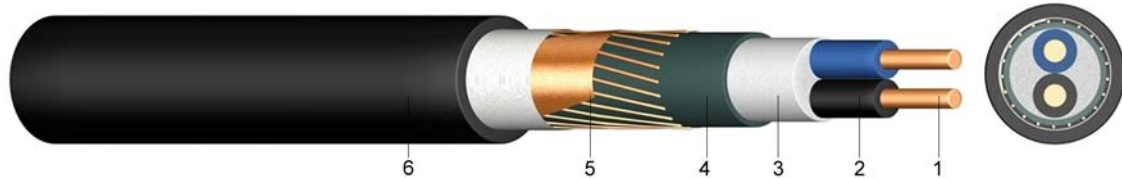

Construction:

- 1 solid or stranded bare copper
- 2 core insulation of halogen-free, cross-linked polyethylene compound
- 3 core covering of halogen-free compound
- 4 anti-twist tape
- 5 concentric conductor formed by copper wires with counter helix of copper tape
- 6 outer sheath of halogen-free, cross-linked polyethylene compound, black

Standards:

DIN VDE 0276-604
 HD 604 S1 part 1 + part 5 G
 DIN EN 60228 class 1 and 2 (construction)
 HD 308 S2 (core identification)

Technical data:

Nominal voltage U ₀ /U	[V]	600 / 1000 Volt
Test voltage	[V] _{AC}	4000
Temperature range	in motion	-5°C till +90°C
Operating temperature	short circuit	250
Short circuit time	max.	[sec]
Bending radius	min.	x diameter
Flammability	standard	EN 50266-2-4 EN 60332-1 IEC 60332-3 Kat.C

Number of cores and nominal cross section mm ²	Price EUR / km	Copper figure kg/km	Cond. construction (appr. value) mm	Overall diameter appr. mm	Calorific potential kwh / m	Weight appr. kg / km
2 x 1,5 RE/ 1,5	4.982,74	54	1 x 1,38	11,5	0,61	177
2 x 2,5 RE/ 2,5	5.575,27	83	1 x 1,78	12,7	0,69	226
3 x 1,5 RE/ 1,5	5.281,35	73	1 x 1,38	11,3	0,68	196
3 x 2,5 RE/ 2,5	6.175,01	113	1 x 1,78	13,2	0,77	253
3 x 4 RE/ 4	7.363,73	168	1 x 2,25	16,0	0,90	336
3 x 6 RE/ 6	9.375,74	250	1 x 2,76	16,0	1,03	441
3 x 10 RE/10	11.552,59	425	1 x 3,56	18,5	1,35	659
3 x 16 RE/16	15.525,46	670	1 x 4,51	21,3	1,74	979
4 x 1,5 RE/ 1,5	5.527,42	88	1 x 1,38	12,6	0,77	221
4 x 2,5 RE/ 2,5	6.526,88	138	1 x 1,78	14,0	0,88	291
4 x 4 RE/ 4	7.960,25	208	1 x 2,25	15,2	1,04	393
4 x 6 RE/ 6	10.249,20	309	1 x 2,76	17,4	1,27	527

Number of cores and nominal cross section mm ²	Price EUR / km	Copper figure kg/km	Cond. construction (appr. value) mm	Overall diameter appr. mm	Calorific potential kwh / m	Weight appr. kg / km
4 x 10 RE/ 10	12.843,60	525	1 x 3,56	19,9	1,62	783
4 x 16 RM/ 16	17.340,89	829	7 x 1,70	23,4	2,19	1.188
4 x 25 RM/ 16	26.513,53	1.190	7 x 2,13	28,1	3,16	1.716
4 x 35 RM/ 16	29.893,71	1.590	7 x 2,52	31,1	3,74	2.193
4 x 50 SM/ 25	38.087,61	2.295	19 x 1,89	33,7	4,57	2.784
4 x 70 SM/ 35	50.129,07	3.210	19 x 2,17	37,2	5,46	3.675
4 x 95 SM/ 50	64.984,73	4.383	19 x 2,52	43,0	6,97	5.063
4 x 120 SM/ 70	78.824,87	5.613	37 x 2,03	47,2	7,84	6.307
4 x 150 SM/ 70	94.985,69	6.813	37 x 2,27	52,0	9,66	7.617
4 x 185 SM/ 95	120.253,36	8.499	37 x 2,52	57,3	11,60	9.462
4 x 240 SM/120	138.478,12	10.985	61 x 2,24	64,3	14,06	12.264
7 x 1,5 RE/ 2,5	7.021,96	139	1 x 1,38	14,4	0,99	314
12 x 1,5 RE/ 2,5	9.588,99	214	1 x 1,38	19,0	1,66	503
7 x 2,5 RE/ 2,5	8.295,04	203	1 x 1,78	16,0	1,21	413
12 x 2,5 RE/ 4	11.980,93	348	1 x 1,78	20,9	1,90	667

J-H(ST)H...Bd Halogenfree Telecommunication Cable

Application: These installation cables are suitable for fixed installations in telecommunication and are to be used in locations with fire hazard to reduce damage in case of fire.

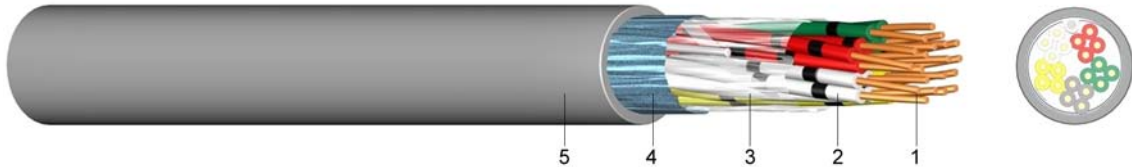

Construction:

- 1 solid bare copper
- 2 core insulation of halogen-free polymer (HI 2)
- 3 layer of foil
- 4 static screen of plastic coated aluminium foil with drain wire
- 5 outer sheath of halogen-free polymer (HM 2), grey, Flame retardant

Information: Cores twisted to star-quads, 5 quads a unit, unit to layers.
Layer identification with coloured tapes.

Standards: DIN VDE 0815 (core identification)
DIN EN 60228 class 1 (construction)
DIN VDE 0207-24

Technical data:

Peak operating voltage		[V]	300 Volt
Temperature range	in motion fixed		- 5°C till +50°C -30°C till +70°C
Bending radius	in motion	x diameter	7,5
Flammability	standard		EN 50266-2-4 IEC 60332-3 Kat.C

Number of pairs and nominal conductor diameter mm	Price EUR / km	Copper figure kg/km	Insulation thickness mm	Overall diameter appr. mm	Calorific potential kWh / m	Weight appr. kg / km
2 x 2 x 0,6	1.808,09	13	1,0	6,0	0,17	49
4 x 2 x 0,6	2.706,54	24	1,0	8,6	0,29	82
6 x 2 x 0,6	3.393,77	36	1,0	9,0	0,34	99
10 x 2 x 0,6	4.547,13	59	1,0	10,4	0,44	135
20 x 2 x 0,6	6.993,88	116	1,0	12,8	0,69	223
30 x 2 x 0,6	9.334,59	172	1,0	14,9	0,92	306
40 x 2 x 0,6	11.436,53	228	1,0	16,7	1,14	386
50 x 2 x 0,6	13.530,48	285	1,4	18,7	1,45	485
100 x 2 x 0,6	22.932,98	568	1,6	25,2	2,62	902
2 x 2 x 0,8	2.686,69	25	1,0	6,8	0,22	66
4 x 2 x 0,8	4.111,43	41	1,0	9,9	0,37	113
6 x 2 x 0,8	5.246,02	62	1,0	10,4	0,43	141
10 x 2 x 0,8	7.355,45	103	1,2	12,2	0,60	200
20 x 2 x 0,8	12.080,93	203	1,4	15,5	0,95	342
30 x 2 x 0,8	16.207,25	304	1,4	18,5	1,38	496

Number of pairs and nominal conductor diameter mm	Price EUR / km	Copper figure kg/km	Insulation thickness mm	Overall diameter appr. mm	Calorific potential kWh / m	Weight appr. kg / km
40 x 2 x 0,8	19.874,50	404	1,4	20,8	1,73	632
50 x 2 x 0,8	23.542,06	505	1,6	22,7	2,05	764
60 x 2 x 0,8	27.192,01	606	1,6	24,9	2,48	920

J-H(ST)H BMK ...Bd

Halogen-Free and Flame Retardant Fire Alarm Cable

Application:

Suitable for fixed installations in telecommunication and are to be used in locations with fire hazard to reduce damage in case of fire.

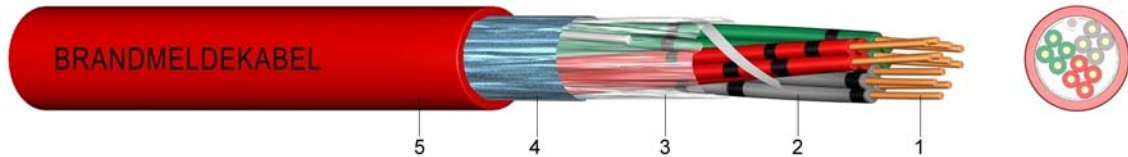

Construction:

- 1 solid bare copper
- 2 core insulation of halogen-free polymer (HI 2)
- 3 layer of plastic foil
- 4 static screen of plastic coated aluminium foil with drain wire 0,6mm or 0,8mm
- 5 outer sheath of halogen-free polymer (HM 2) red with the marking "BRANDMELDEKABEL" (fire alarm cable)

Information:

Cores twisted to star-quads, 5 quads a unit, unit to layers.
Layer identification with coloured tapes.

Standards:

DIN VDE 0815 (core identification)
DIN EN 60228 class 1 (construction)
DIN VDE 0207-24

Technical data:

Peak operating voltage		[V]	300 Volt
Temperature range	in motion		- 5°C till +50°C
	fixed		-30°C till +70°C
Bending radius	in motion	x diameter	7,5
Flammability	standard		EN 50266-2-4 IEC 60332-3 Kat.C

Number of pairs and nominal conductor diameter mm	Price EUR / km	Copper figure kg/km	Insulation thickness mm	Overall diameter mm	Calorific potential kWh / m	Weight appr. kg / km
1 x 2 x 0,8	2.483,05	11	1,0	6,5	0,15	60
2 x 2 x 0,8	2.686,69	25	1,0	6,8	0,22	66
4 x 2 x 0,8	4.111,43	41	1,0	9,9	0,37	113
6 x 2 x 0,8	5.246,02	62	1,0	10,4	0,43	141
10 x 2 x 0,8	7.355,45	102	1,2	12,2	0,60	200
20 x 2 x 0,8	12.080,93	203	1,4	15,5	0,95	342
40 x 2 x 0,8	19.874,50	404	1,4	20,8	1,80	632
50 x 2 x 0,8	23.542,06	505	1,6	22,7	2,05	764
60 x 2 x 0,8	27.192,01	606	1,6	24,9	2,48	920

J-H(ST)Hh EIB MSR Installation Cable with Static Screen European Installation Bus Halogen-Free Version

Application: For the installation on and under plaster in dry, humid and wet rooms as well as outside (by protected installation) in Strongly and weak stream arrangements, as BUS cable as well as as a MSR cable in strong stream arrangements. The transference of measuring values, the application in the process data processing as well as the use in the area of the tax technology and control technology are the main areas of application of this cable.



Construction:

- 1 solid bare copper
- 2 core insulation of halogen-free copolymer
- 3 layer of plastic foil
- 4 static screen of plastic laminated aluminium foil with drain wire
- 5 outer sheath of halogen-free copolymer, green or grey

Information: Cores twisted to starquads.

Standards: DIN VDE 0815 (core identification)
DIN EN 60228 class 1 (construction)
EIBA pecification

Technical data:

Peak operating voltage		[V]	300
Temperature range	in motion		-5°C till +50°C
Conductor resistance	max.	[Ohm/km]	73,2
Insulation resistance	min.	[MOhm/km]	100
Mutal capacitance	at 800 Hz	[nF] max.	100
Test voltage	Core / Core	[KV] 5min.	1
	Core and Screen on conductorsurface standard	[KV] 1min.	4
Flammability			EN 50266-2-4 IEC 60332-1

Number of pairs and nominal conductor diameter mm	Price EUR / km	Copper figure kg/km	Overall diameter appr. mm	Calorific potential kWh / m	Weight appr. kg / km
2 x 2 x 0,8	2.446,42	21	8,5	0,22	60

**(N)HXH
FE180/E30
KERAM**

**Halogen-Free Cable with
Circuit Integrity of 30 Minutes**

Application:

Safety cables are used in all locations where a high degree of protection against fire and fire-damage has to be provided for human life and equipment and are, therefore, subject to high security requirements. These cables may be used indoors and outdoors. They may not be installed directly into the ground and into the water. This cable conforms with Safety Class II standards. Functional integrity of 30 minutes and insulation integrity of 180 minutes.

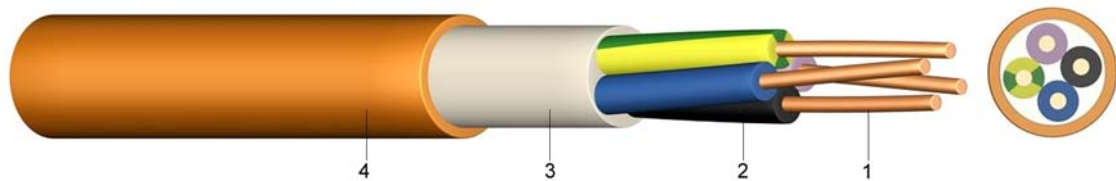

Construction:

- 1 solid or stranded bare copper
- 2 core insulation of halogen-free, similar ceramic polymer compound (HXI 1)
- 3 halogen-free inner sheath
- 4 outer sheath of halogen-free polymere (HM4), orange

Information:

These cables fulfil the conditions of the tests to insulation integrity according to DIN VDE 0472-814/ 8.83 about 180 min. and IEC Public. 331 first edition 1970 to circuit integrity about 30 min. to DIN 4102-12 according to VDE 0100-710 and 0100-718.

Standards:

- adapted to DIN VDE 0266
- DIN VDE 0276-604
- DIN VDE 0472-814
- DIN EN 60228 class 1 and 2 (construction)
- HD 308 S2 (core identification)

Technical data:

Nominal voltage U ₀ /U		[V]	600 / 1000 Volt
Test voltage		[V] _{AC}	4000
Temperature range	in motion		-5°C till +90°C
Operating temperature	short circuit	°C	250
Short circuit time	max.	[sec]	5
Bending radius	single core style	x diameter	15
	multi core style	x diameter	12
Flammability	standard		EN 50266-2-4 IEC 60332-3 Kat.C

Number of cores and nominal cross section mm ²	Price EUR / km J	Price EUR / km O	Copper figure kg/km	Overall diameter appr.mm	Calorific potential kWh/m	Weight appr. kg/km
1 x 16 RM		5.464,88	160	9,0	0,30	207
1 x 25 RM		7.518,91	250	10,6	0,40	307
1 x 35 RM		9.187,55	350	11,8	0,46	407
1 x 50 RM	11.230,52	11.230,52	500	13,1	0,54	535
1 x 70 RM	14.531,34	14.531,34	700	15,0	0,66	744
1 x 95 RM		17.753,40	950	17,0	0,80	1.009

Number of cores and nominal cross section mm ²	Price EUR / km J	Price EUR / km O	Copper figure kg/km	Overall diameter appr.mm	Calorific potential kWh/m	Weight appr. kg/km
1 x 120 RM		20.824,08	1.200	18,6	0,91	1.248
1 x 150 RM		23.986,60	1.500	20,6	1,14	1.538
1 x 185 RM		28.766,43	1.850	22,8	1,35	1.917
1 x 240 RM		36.714,38	2.400	26,3	1,56	2.521
1 x 300 RM		41.500,14	3.000	30,0	2,50	3.400
2 x 1,5 RE		5.108,63	30	10,2	0,45	145
2 x 2,5 RE		5.589,46	50	11,0	0,52	180
2 x 4 RE		7.008,41	80	11,8	0,57	224
2 x 6 RE		8.898,77	120	12,8	0,65	282
2 x 10 RE		12.343,19	200	14,4	0,78	393
2 x 16 RM		14.643,16	320	17,3	1,04	605
3 x 1,5 RE	5.633,31		45	10,6	0,50	165
3 x 2,5 RE	6.784,04		75	11,5	0,57	209
3 x 4 RE	8.527,29		120	12,4	0,64	268
3 x 6 RE	10.694,83		180	13,5	0,72	344
3 x 10 RE	13.602,91		300	15,6	0,90	506
3 x 16 RM	16.510,24		480	18,0	1,14	761
3 x 25 RM	25.051,88		750	22,3	1,63	1.160
3 x 35 RM	35.462,04		1.050	24,9	1,92	1.522
3 x 50 RM	38.775,12		1.500	27,7	2,30	1.980
3 x 70 RM	48.095,31		2.100	32,0	2,96	2.746
3 x 95 RM	62.805,09		2.850	36,5	3,67	3.712
3 x 25/16 RM	32.177,10		910	23,4	1,76	1.335
3 x 35/16 RM	36.294,46		1.210	25,7	2,02	1.683
3 x 50/25 RM	41.286,40		1.750	29,0	2,50	2.244
3 x 70/35 RM	52.422,11		2.450	33,4	3,18	3.101
3 x 95/50 RM	69.346,06		3.350	38,3	4,04	4.207
3 x 120/70 RM	88.028,40		4.300	42,6	4,92	5.315
4 x 1,5 RE	6.219,78		60	11,3	0,56	192
4 x 2,5 RE	7.367,61		100	12,3	0,64	249
4 x 4 RE	11.250,00		160	13,3	0,72	322
4 x 6 RE	13.544,55		240	14,5	0,82	418
4 x 10 RE	18.133,48		400	16,8	1,01	620
4 x 16 RM	28.718,65		640	19,8	1,31	944
4 x 25 RM	38.390,03		1.000	24,3	1,92	1.452
4 x 35 RM	46.007,57		1.400	27,1	2,23	1.906
4 x 50 RM	60.939,38		2.000	30,5	2,79	2.514
4 x 70 RM	77.298,29		2.800	35,3	3,58	3.497
4 x 95 RM	94.035,46		3.800	40,2	3,87	4.728
4 x 120 RM	124.731,36		4.800	44,5	5,37	5.882
4 x 150 RM	149.799,39		6.000	49,0	6,51	7.199
5 x 1,5 RE	9.561,01		75	12,2	0,66	228
5 x 2,5 RE	11.058,50		125	13,3	0,75	295
5 x 4 RE	15.482,41		200	14,4	0,84	386
5 x 6 RE	17.369,24		300	16,1	1,01	518
5 x 10 RE	22.774,69		500	18,3	1,22	755
5 x 16 RM	34.888,05		800	22,2	1,64	1.187
5 x 25 RM	45.933,67		1.250	26,6	2,29	1.773
5 x 35 RM	55.048,04		1.750	29,8	2,72	2.341
5 x 50 RM	72.670,39		2.500	33,7	3,44	3.100
7 x 1,5 RE	11.058,50		105	13,0	0,73	274
10 x 1,5 RE	14.158,65		150	16,4	1,01	397
12 x 1,5 RE	15.739,83		180	16,8	1,08	438
19 x 1,5 RE	26.246,64		285	19,2	1,41	606
24 x 1,5 RE	31.480,24		360	22,6	1,78	785
30 x 1,5 RE	37.051,38		450	23,7	2,02	917

Number of cores and nominal cross section mm²	Price EUR / km J	Price EUR / km O	Copper figure kg/km	Overall diameter appr.mm	Calorific potential kWh/m	Weight appr. kg/km
7 x 2,5 RE	13.859,48		175	14,2	0,83	358
12 x 2,5 RE	18.709,79		300	18,0	1,24	580
19 x 2,5 RE	29.436,70		475	21,8	1,70	852
24 x 2,5 RE	35.485,75		600	25,0	2,05	1.054
30 x 2,5 RE	41.970,52		750	26,3	2,33	1.245

More types on enquiry

**(N)HXCH
FE180/E30
KERAM**

**Halogen-Free Cable with Concentric Conductor and
Circuit Integrity of 30 Minutes**

Application:

Safety cables are used in all locations where a high degree of protection against fire and fire-damage has to be provided for human life and equipment and are, therefore, subject to high security requirements. These cables may be used indoors and outdoors. They may not be installed directly into the ground and into the water. Functional integrity of 30 minutes and insulation integrity of 180 minutes.

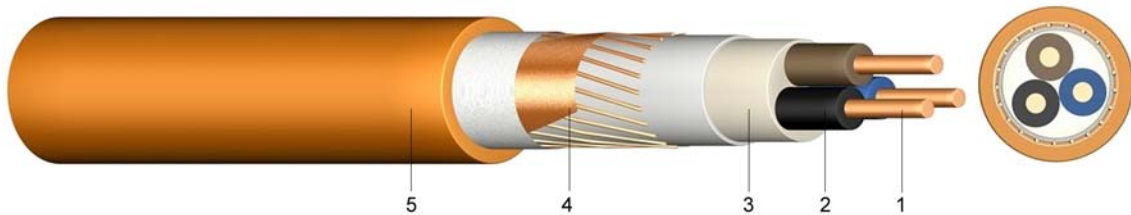

Construction:

- 1 solid or stranded bare copper
- 2 core insulation of halogen-free, similar ceramic polymer compound (HXI 1)
- 3 halogen-free inner sheath
- 4 concentric conductor formed by copper wires with counter helix of copper tape
- 5 outer sheath of halogen-free polymer (HM 4), orange

Information:

These cables fulfil the conditions of the tests to insulation integrity according to DIN VDE 0472-814/ 8.83 about 180 min. and IEC Public. 331 first edition 1970 to circuit integrity about 30 min. to DIN 4102-12 according to VDE 0100-710 and 0100-718.

Standards:

- adapted to DIN VDE 0266
- DIN VDE 0276-604
- DIN VDE 0472-814
- DIN EN 60228 class 1 and 2 (construction)
- HD 308 S2 (core identification)

Technical data:

Nominal voltage U ₀ /U		[V]	600 / 1000 Volt
Test voltage		[V] _{AC}	4000
Temperature range	in motion	°C	-5°C till +90°C
Operating temperature	short circuit	°C	250
Short circuit time	max.	[sec]	5
Bending radius	in motion	x diameter	12
Flammability	standard		EN 50266-2-4 IEC 60332-3 Kat.C

Number of cores and nominal cross section mm ²	Price EUR / km	Copper figure kg/km	Overall diameter appr.mm	Calorific potential kWh/m	Weight appr. kg/km
2 x 1,5 RE/1,5	6.813,14	54	10,8	0,40	133
2 x 2,5 RE/2,5	7.595,08	83	12,0	0,46	171
3 x 1,5 RE/1,5	7.792,81	73	11,2	0,50	166
3 x 2,5 RE/2,5	8.457,86	113	12,5	0,58	219
3 x 4 RE/4	10.356,39	168	13,4	0,66	291

Number of cores and nominal cross section mm ²	Price EUR / km	Copper figure kg/km	Overall diameter appr.mm	Calorific potential kWh/m	Weight appr. kg/km
3 x 6 RE/ 6	13.290,83	250	15,3	0,78	393
3 x 10 RE/ 10	16.388,57	425	17,0	0,92	576
3 x 16 RE/ 16	20.732,70	670	19,6	1,15	860
3 x 25 RM/ 16	28.661,82	1.045	23,0	1,57	1.194
3 x 35 RM/ 16	37.665,15	1.460	25,6	1,86	1.521
3 x 50 RM/ 25	46.808,70	2.083	28,8	2,28	2.037
3 x 70 RM/ 35	61.523,99	2.913	33,7	3,05	2.841
3 x 95 RM/ 50	78.696,58	3.949	38,2	3,73	3.840
3 x 120 RM/ 70	99.417,86	4.985	42,3	4,50	4.869
3 x 150 RM/ 70	99.322,76	5.313	46,6	5,63	5.844
3 x 185 RM/ 95	142.683,25	6.649	52,3	6,99	7.400
3 x 240 RM/120	159.339,34	8.585	59,7	9,08	9.661
4 x 1,5 RE/ 1,5	8.779,72	88	11,9	0,55	192
4 x 2,5 RE/ 2,5	9.686,26	138	13,3	0,64	254
4 x 4 RE/ 4	11.990,18	208	14,3	0,71	341
4 x 6 RE/ 6	14.839,00	309	16,3	0,85	471
4 x 10 RE/ 10	21.435,15	525	18,2	1,00	685
4 x 16 RM/ 16	28.272,13	829	21,1	1,24	1.035
4 x 25 RM/ 16	36.035,38	1.190	25,0	1,71	1.465
4 x 35 RM/ 16	43.509,98	1.590	27,8	2,03	1.886
4 x 50 RM/ 25	52.654,75	2.295	31,6	2,52	2.539
4 x 70 RM/ 35	65.072,20	3.210	37,0	3,39	3.556
4 x 95 RM/ 50	86.886,82	4.383	41,9	4,12	4.816
4 x 120 RM/ 70	113.305,53	5.613	46,6	5,05	6.101
4 x 150 RM/ 70	133.519,85	6.813	51,1	6,13	7.323
4 x 185 RM/ 95	164.255,79	8.499	57,6	7,73	9.285
4 x 240 RM/120	196.501,58	10.985	65,8	10,02	12.141
5 x 2,5 RE/ 2,5	14.880,02	315	14,3	0,65	283
5 x 6 RE/ 6	22.207,78	490	17,5	0,84	530
7 x 1,5 RE/ 2,5	12.474,54	139	14,2	0,69	274
12 x 1,5 RE/ 2,5	20.034,91	214	17,4	0,95	399
24 x 1,5 RE/ 6	36.875,12	430	23,7	1,55	744
30 x 1,5 RE/ 6	39.008,96	520	24,8	1,77	873
7 x 2,5 RE/ 2,5	14.817,58	208	15,4	0,77	348
12 x 2,5 RE/ 4	22.728,96	348	19,2	1,09	556
24 x 2,5 RE/ 10	36.416,21	725	26,1	1,76	1.027
30 x 2,5 RE / 10	42.911,99	875	27,4	2,02	1.216

More types on enquiry

JE-H(ST)H E30 ...Bd

Halogen-Free and Flame Retardant Installation Cable for Industrial Electronics with Circuit Integrity of 30 Minutes

Application:

Suitable for fixed installations in telecommunication. They are to be used in locations with fire hazard and where insulation integrity of at least 180 minutes and circuit integrity of at least 30 minutes are required.

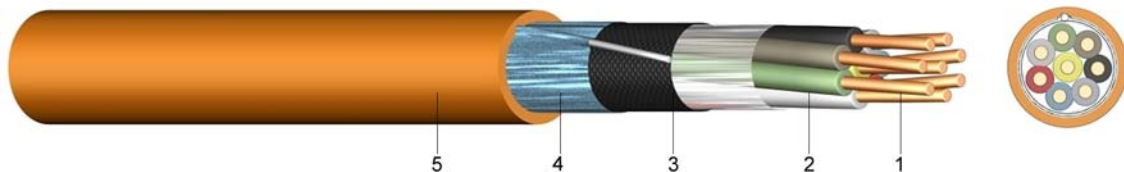

Construction:

- 1 solid bare copper
- 2 core insulation of halogen-free, similar ceramic polymer compound (HI 1), stranded to pairs
- 3 layer of plastic foil
- 4 static screen of plastic coated metal foil with a solid tinned drain wire 0,8mm
- 5 outer sheath of halogen-free polymer (HM 2), orange

Information:

These cables fulfil the conditions of the tests to insulation integrity according to DIN VDE 0472-814/ 8.83 about 180 min. and IEC Public. 331 first edition 1970 to circuit integrity about 30 min. to DIN 4102-12 according to VDE 0100-710 and 0100-718.

Standards:

DIN VDE 0815 (core identification)
DIN EN 60228 class 1 (construction)
DIN VDE 0207-24

Technical data:

Peak operating voltage		[V]	225 Volt
Temperature range	in motion fixed		- 5°C till +50°C -30°C till +70°C
Bending radius	in motion	x diameter	7,5
Flammability	standard		EN 50266-2-4 EN 60332-1 IEC 60332-3 Kat.C
Insulation resistance	standard min.	[MΩ/km]	100
Mutal capacitance		[Ω/km]	73,2
	max.	[nF/km]	120
Capacitance unbalance 100m	max	[pF]	200

Number of pairs and nominal conductor diameter mm	Price EUR / km	Copper figure kg/km	Insulation thickness mm	Overall diameter appr. mm	Calorific potential kWh / m	Weight appr. kg / km
2 x 2 x 0,8	7.404,78	25	1,0	6,6	0,13	86
4 x 2 x 0,8	12.296,84	45	1,0	8,8	0,20	138
8 x 2 x 0,8	19.901,75	85	1,2	12,8	0,34	220
12 x 2 x 0,8	27.570,11	126	1,2	13,5	0,39	298
20 x 2 x 0,8	42.223,30	206	1,4	16,1	0,53	465
32 x 2 x 0,8	59.647,07	340	1,4	20,6	0,85	704

JE-H(ST)H BMK ...Bd E30

Halogen-Free and Flame Retardant Installation Cable for Fire Detection Circuits with Circuit Integrity of 30 Minutes

Application:

Suitable for fixed installations in fire detection circuits. They are to be used in locations with fire hazard and where an insulation integrity of at least 180 minutes and a circuit integrity of at least 30 minutes are required.

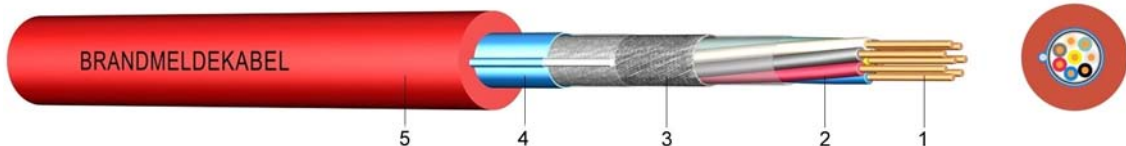

Construction:

- 1 solid bare copper
- 2 core insulation of halogen-free, similar ceramic polymer compound (HI 1), twisted
- 3 layer of plastic foil
- 4 static screen of plastic coated aluminium foil with a solid tinned drain wire 0,8 mm
- 5 outer sheath of halogen-free polymer (HM 2) red with the marking "BRANDMELDEKABEL" (fire alarm cable)

Information:

These cables fulfil the conditions of the tests to insulation integrity according to DIN VDE 0472-814/ 8.83 about 180 min. and IEC Public. 331 first edition 1970 to circuit integrity about 30 min. to DIN 4102-12 according to VDE 0100-710 and 0100-718.

Standards:

- DIN VDE 0815 (core identification)
- DIN EN 60228 class 1 (construction)
- DIN VDE 0207-24

Technical data:

Peak operating voltage		[V]	225 Volt
Temperature range	in motion		- 5°C till +50°C
	fixed		-30°C till +70°C
Bending radius	in motion	x diameter	7,5
Flammability	standard		EN 50266-2-4
	standard		EN 60332-1
	standard		IEC 60332-3 Kat.C
Insulation resistance	min.	[MΩ/km]	100
Mutal capacitance		[Ω/km]	73,2
	max.	[nF/km]	120
Capacitance unbalance 100m	max	[pF]	200

Number of pairs and nominal conductor diameter mm	Price EUR / km	Copper figure kg/km	Insulation thickness mm	Overall diameter appr. mm	Calorific potential kWh / m	Weight appr. kg / km
2 x 2 x 0,8	7.404,78	25	1,0	6,6	0,13	61
4 x 2 x 0,8	12.296,84	45	1,0	8,8	0,20	104
8 x 2 x 0,8	19.901,75	85	1,2	12,8	0,34	218
12 x 2 x 0,8	27.570,11	126	1,2	13,5	0,39	235
20 x 2 x 0,8	42.223,30	206	1,4	16,1	0,53	367

NHXH E90

Halogen-Free Cable with Circuit Integrity of 90 Minutes

Application:

Safety cables are used in all locations where a high degree of protection against fire and fire-damage has to be provided for human life and equipment and are, therefore, subject to high security requirements. These cables may be used indoors and outdoors. They may not be installed directly into the ground and into the water. Functional integrity of 90 minutes and insulation integrity of 180 minutes.

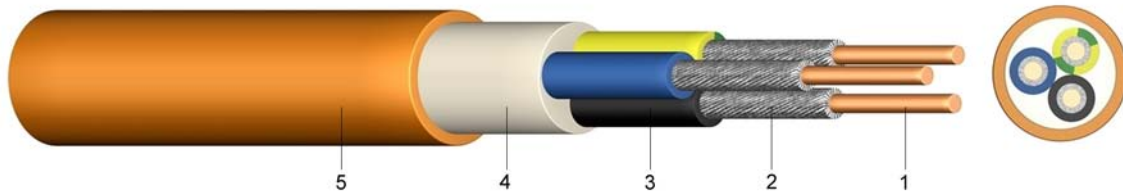

Construction:

- 1 solid or stranded bare copper
- 2 flame protective wrapping
- 3 core insulation of halogen-free polymer (HXI 1)
- 4 halogen-free core covering
- 5 outer sheath of halogen-free polymer (HM 4), orange

Information:

These cables fulfil the conditions of the tests to insulation integrity according to DIN VDE 0472-814/ 8.83 about 180 min. and IEC Public. 331 first edition 1970 to circuit integrity about 30 min. to DIN 4102-12 according to VDE 0100-710 and 0100-718.

Standards:

- DIN VDE 0266
- DIN VDE 0276-604
- DIN EN 60228 class 1 and 2 (construction)
- HD 308 S2 (core identification)

Technical data:

Nominal voltage U ₀ /U		[V]	600 / 1000 Volt
Test voltage		[V] _{AC}	4000
Temperature range	in motion		-5°C till +90°C
Operating temperature	short circuit	°C	250
Short circuit time	max.	[sec]	5
Bending radius	single core style	x diameter	15
	multi core style	x diameter	12
Flammability	standard		EN 50266-2-4 IEC 60332-3 Kat.C

Number of cores and nominal cross section mm ²	Price EUR / km J	Price EUR / km O	Copper figure kg/km	Overall diameter appr.mm	Calorific potential kWh/m	Weight appr. kg/km
1 x 16 RM	12.398,40	12.398,40	160	10,5	0,42	250
1 x 25 RM		17.375,72	250	12,5	0,53	355
1 x 35 RM	26.400,46	26.400,46	350	13,5	0,60	460
1 x 50 RM	31.380,53	31.380,53	500	15,0	0,69	596
1 x 70 RM	34.772,49	34.772,49	700	16,5	0,83	810
1 x 95 RM	44.554,05	44.554,05	950	19,0	1,06	1.100
1 x 120 RM	54.477,43	54.477,43	1.200	20,5	1,15	1.350

Number of cores and nominal cross section mm ²		Price EUR / km J	Price EUR / km O	Copper figure kg/km	Overall diameter appr.mm	Calorific potential kWh/m	Weight appr. kg/km
1 x 150	RM	64.843,41	64.843,41	1.500	22,5	1,38	1.650
1 x 185	RM		81.069,08	1.850	25,0	1,68	2.050
1 x 240	RM		96.935,89	2.400	28,0	1,84	2.650
1 x 300	RM		126.108,31	3.000	31,0	2,18	3.275
2 x 1,5	RE		12.966,69	30	14,3	0,69	275
2 x 2,5	RE		13.642,92	50	14,9	0,78	320
3 x 1,5	RE	13.522,12		45	15,0	1,02	315
3 x 2,5	RE	15.955,74		75	15,9	1,12	371
3 x 4	RE	16.854,89		120	16,7	1,21	435
3 x 6	RE	19.150,02		180	17,8	1,34	526
3 x 10	RE	24.309,50		300	19,5	1,54	691
3 x 16	RM	38.920,45		480	22,3	1,90	982
3 x 25	RM	62.000,58		750	25,8	2,48	1.392
3 x 35	RM	70.876,71		1.050	28,4	2,87	1.778
3 x 35/16	RM	68.916,69		1.210	29,5	3,06	1.964
3 x 50/25	RM	75.205,17		1.750	33,6	3,94	2.633
3 x 70/35	RM	92.984,28		2.450	38,1	4,81	3.563
3 x 95/50	RM	119.806,77		3.350	43,4	6,16	4.768
3 x 120/70	RM	149.777,94		4.300	46,9	6,96	5.856
4 x 1,5	RE	15.811,85		60	16,1	1,16	365
4 x 2,5	RE	18.044,58		100	17,0	1,27	429
4 x 4	RE	19.739,05		160	18,0	1,38	515
4 x 6	RE	22.495,79		240	19,2	1,54	628
4 x 10	RE	29.609,05	29.609,05	400	21,1	1,77	839
4 x 16	RM	49.096,59	49.096,59	640	24,3	2,19	1.210
4 x 25	RM	68.332,65	68.332,65	1.000	28,1	2,85	1.717
4 x 35	RM	76.789,21	76.789,21	1.400	31,0	3,29	2.209
4 x 50	RM	91.808,95	91.808,95	2.000	35,1	4,21	2.921
4 x 70	RM	113.425,41	113.425,41	2.800	40,0	5,20	3.980
4 x 95	RM	151.659,49	151.659,49	3.800	45,2	6,56	5.321
4 x 120	RM	185.030,99	185.030,99	4.800	49,0	7,38	6.475
4 x 150	RM	260.105,67		6.000	53,0	8,62	7.725
5 x 1,5	RE	18.574,11		75	17,4	1,34	429
5 x 2,5	RE	22.461,96		125	18,4	1,45	506
5 x 4	RE	24.874,17		200	19,5	1,59	612
5 x 6	RE	28.941,02		300	20,9	1,77	752
5 x 10	RE	35.140,28		500	23,0	2,04	1.009
5 x 16	RM	58.702,58		800	26,6	2,51	1.465
5 x 25	RM	82.772,87		1.250	30,9	3,35	2.105
5 x 35	RM	105.139,95		1.750	36,0	3,75	2.500
7 x 1,5	RE	24.257,77		105	18,6	1,57	497
12 x 1,5	RE	40.180,82		180	23,5	2,33	744
7 x 2,5	RE	30.765,41		175	19,8	1,74	599
12 x 2,5	RE	47.882,66		300	25,2	2,57	910

More types on enquiry

NHXCH E90 Halogen-Free Cable with Concentric Conductor and Circuit Integrity of 90 Minutes

Application: Safety cables are used in all locations where a high degree of protection against fire and fire-damage has to be provided for human life and equipment and are, therefore, subject to high security requirements. These cables may be used indoors and outdoors. They may not be installed directly into the ground and into the water. Functional integrity of 90 minutes and insulation integrity of 180 minutes.

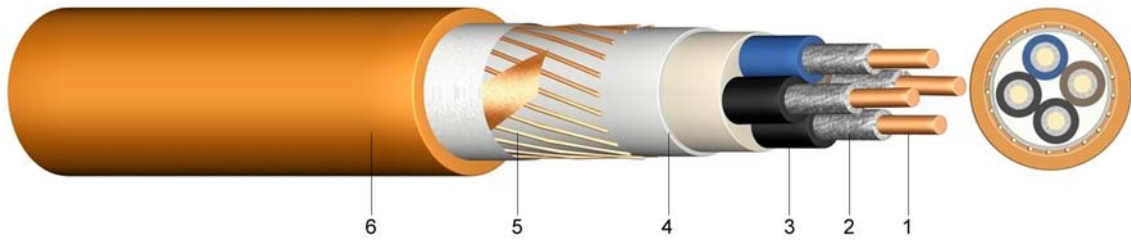

- Construction:**
- 1 solid or stranded bare copper
 - 2 flame protective wrapping
 - 3 core insulation of halogen-free polymer (HXI 1)
 - 4 halogen-free inner sheath
 - 5 concentric conductor formed by copper wires with counter helix of copper tape
 - 6 outer sheath of halogen-free polymer (HM 4), orange

Information: These cables fulfil the conditions of the tests to insulation integrity according to DIN VDE 0472-814/ 8.83 about 180 min. and IEC Public. 331 first edition 1970 to circuit integrity about 30 min. according to VDE 0100-710 and 0100-718.

- Standards:**
- DIN VDE 0266
 - DIN VDE 0276-604
 - DIN EN 60228 class 1 and 2 (construction)
 - HD 308 S2 (core identification)

Technical data:

Nominal voltage U ₀ /U		[V]	600 / 1000 Volt
Test voltage		[V] _{AC}	4000
Temperature range	in motion		-5°C till +90°C
Operating temperature	short circuit	°C	250
Short circuit time	max.	[sec]	5
Bending radius	in motion	x diameter	12,0
Flammability	standard		EN 50266-2-4 IEC 60332-3 Kat.C

Number of cores and nominal cross section mm ²	Price EUR / km	Copper figure kg / km	Overall diameter appr.mm	Calorific potential kWh/m	Weight appr. kg/km
2 x 1,5 RE/1,5	15.116,10	54	16,0	0,72	300
2 x 2,5 RE/2,5	15.960,98	83	17,0	0,81	350
3 x 1,5 RE/1,5	17.347,46	73	16,8	1,12	363
3 x 2,5 RE/2,5	18.686,01	113	17,9	1,24	434
3 x 4 RE/4	21.241,69	168	19,0	1,35	434
3 x 6 RE/6	24.095,79	250	21,0	1,49	434

Number of cores and nominal cross section mm ²	Price EUR / km	Copper figure kg / km	Overall diameter appr.mm	Calorific potential kWh/m	Weight appr. kg/km
3 x 10 RE/ 10	28.824,63	425	24,1	2,06	949
3 x 16 RE/ 16	38.505,94	670	27,3	2,43	1.340
3 x 25 RE/ 16	57.304,57	1.045	30,7	3,22	1.766
3 x 35 RE/ 16	68.727,55	1.460	33,3	3,64	2.172
3 x 50 RE/ 25	79.680,65	2.083	37,4	4,51	2.857
3 x 70 RE/ 35	109.358,57	2.913	42,5	5,58	3.839
3 x 95 RE/ 50	146.248,21	3.949	47,8	7,00	5.082
3 x 120 RE/ 50	180.790,61	4.985	51,4	7,83	6.204
3 x 150 RE/ 70	208.596,16	5.313	55,7	9,21	7.340
3 x 185 RE/ 95	256.321,10	6.649	61,7	11,07	9.142
3 x 240 RE/ 120	292.481,99	8.585	67,9	13,36	11.582
4 x 1,5 RE/ 1,5	21.587,78	88	18,0	1,11	450
4 x 2,5 RE/ 2,5	22.933,55	138	19,2	1,42	505
4 x 4 RE/ 4	25.783,96	208	20,3	1,53	608
4 x 6 RE/ 6	28.518,20	310	22,5	1,71	777
4 x 10 RE/ 10	36.564,41	525	26,4	2,42	1.153
4 x 16 RM/ 16	51.868,42	829	29,3	2,75	1.584
4 x 25 RM/ 16	69.109,68	1.190	33,1	3,67	2.120
4 x 35 RM/ 16	76.877,60	1.590	36,0	4,14	2.634
4 x 50 RM/ 25	88.425,03	2.295	41,1	5,38	3.524
4 x 70 RM/ 35	115.966,53	3.210	46,2	6,46	4.695
4 x 95 RM/ 50	157.161,73	4.383	52,0	8,09	6.242
4 x 120 RM/ 70	195.059,49	5.613	56,0	9,04	7.622
4 x 150 RM/ 70	233.763,65	6.813	61,0	10,78	9.096
4 x 185 RM/ 95	296.739,69	8.499	67,5	12,92	11.307
4 x 240 RM/120	380.889,87	10.985	74,4	15,60	14.359
7 x 1,5 RE/ 1,5	30.112,91	139	20,9	1,67	588
12 x 1,5 RE/ 2,5	47.547,87	214	26,2	2,57	620
24 x 1,5 RE/ 6	90.453,78	430	37,6	5,66	1.979
7 x 2,5 RE/ 2,5	34.954,23	208	22,1	1,91	696
12 x 2,5 RE/ 2,5	53.149,10	348	28,2	2,83	1.168
24 x 2,5 RE/ 2,5	101.877,29	725	41,0	6,56	2.465

More types on enquiry

JE-H(ST)H E90 ...Bd

Halogen-Free and Flame Retardant Installation Cable for Industrial Electronics with Circuit Integrity of 90 Minutes

Application:

Suitable for fixed installations in telecommunication. They are to be used in locations with fire hazard and where insulation integrity of at least 180 minutes and circuit integrity of at least 90 minutes are required.

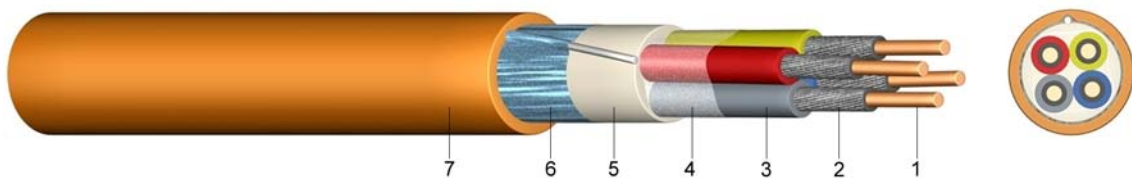

Construction:

- 1 solid bare copper
- 2 flame protective wrapping
- 3 core insulation of halogen-free, cross-linked polymer (HI 1)
- 4 core covering of foil
- 5 halogen-free inner sheath
- 6 static screen of plastic coated metal foil with a solid tinned drain wire 0,8 mm
- 7 outer sheath of halogen-free polymer (HM 2), orange

Information:

These cables fulfil the conditions of the tests to insulation integrity according to DIN VDE 0472-814/ 8.83 about 180 min. and IEC Public. 331 first edition 1970 to circuit integrity about 30 min. to DIN 4102-12 according to VDE 0100-710 and 0100-718.

Standards:

- DIN VDE 0815 (core identification)
- DIN EN 60228 class 1 (construction)
- DIN VDE 0207-24

Technical data:

Peak operating voltage		[V]	225
Temperature range	in motion fixed		- 5°C till +50°C -30°C till +70°C
Bending radius	in motion	x diameter	7,5
Flammability	standard		EN 50226-2-4 EN 60332-1 IEC 60332-3 Kat.C
Insulation resistance	min.	[MΩ/km]	100
Mutal capacitance		[Ω/km]	73,2
	max.	[nF/km]	120
Capacitance unbalance 100m	max	[pF]	200

Number of pairs and nominal conductor diameter mm	Price EUR / km	Copper figure kg/km	Insulation thickness mm	Overall diameter appr.mm	Calorific potential kWh / m	Weight appr. kg / km
2 x 2 x 0,8	9.149,33	25	1,0	12,8	0,56	177
4 x 2 x 0,8	15.192,72	45	1,0	16,3	0,85	284
8 x 2 x 0,8	24.592,59	85	1,2	20,3	1,33	447
12 x 2 x 0,8	34.062,43	126	1,2	23,9	1,84	615
16 x 2 x 0,8	43.590,07	166	1,4	22,5	2,22	756
20 x 2 x 0,8	52.160,85	206	1,4	29,4	2,72	921

JE-H(ST)H BMK ...Bd E90

Halogen-Free and Flame Retardant Installation Cables for Industrial Electronics with Circuit Integrity of 90 Minutes

Application:

Suitable for fixed installations in telecommunication. They are to be used in locations with fire hazard and where insulation integrity of at least 180 minutes and circuit integrity of at least 90 minutes are required.

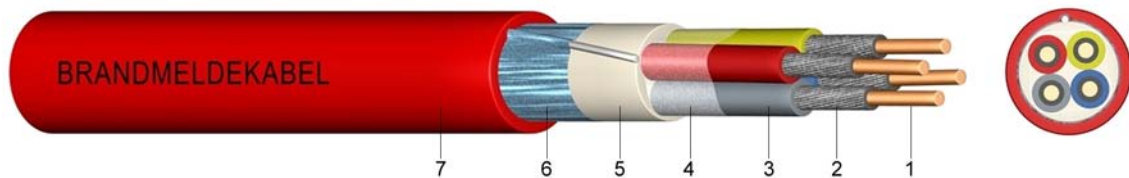

Construction:

- 1 solid bare copper
- 2 core covering with glassfibre tape (MICA)
- 3 core insulation of halogen-free, cross-linked polymer (HI 1)
- 4 layer of plastic foil
- 5 static screen of plastic laminated aluminium foil with a solid tinned drain wire 0,8 mm
- 6 outer sheath of halogen-free polymer (HM 2) red with the marking "BRANDMELDEKABEL" (fire alarm cable)

Information:

These cables fulfil the conditions of the tests to insulation integrity according to DIN VDE 0472-814/ 8.83 about 180 min. and IEC Public. 331 first edition 1970 to circuit integrity about 30 min. to DIN 4102-12 according to VDE 0100-710 and 0100-718.

Standards:

DIN VDE 0815 (core identification)
DIN EN 60228 class 1 (construction)
DIN VDE 0207-24

Technical data:

Peak operating voltage		[V]	225 Volt
Temperature range	in motion fixed		- 5°C till +50°C -30°C till +70°C
Bending radius	in motion	x diameter	7,5
Flammability	standard		EN 50226-2-4 EN 60332-1 IEC 60332-3 Kat.C
Insulation resistance	min.	[MΩ/km]	100
Mutal capacitance		[Ω/km]	73,2
	max.	[nF/km]	120
Capacitance unbalance 100m	max	[pF]	200

Number of pairs and nominal conductor diameter mm	Price EUR / km	Copper figure kg/km	Insulation thickness mm	Overall diameter appr.mm	Calorific potential kWh / m	Weight appr. kg / km
2 x 2 x 0,8	9.149,33	25	1,0	12,8	0,56	177
4 x 2 x 0,8	15.192,72	45	1,0	16,3	0,85	284
8 x 2 x 0,8	24.592,59	85	1,2	20,3	1,33	447
12 x 2 x 0,8	33.741,07	126	1,2	23,9	1,84	615
16 x 2 x 0,8	43.590,07	166	1,4	26,6	2,22	756
20 x 2 x 0,8	51.668,76	206	1,4	29,4	2,72	921

JB-YY

Fire Alarm Cable

Application:

They are suitable for fixed installation indoors and are used for fire alarm systems.



Construction:

- 1 solid bare copper, \varnothing 0,8mm
- 2 core insulation of polyvinylchloride (PVC)
- 3 outer sheath of polyvinylchloride (PVC), red with the marking "BRANDMELDEKABEL" (fire alarm cable)

Standards:

- DIN VDE 0815 (core identification)
DIN EN 60228 class 1 (construction)

Technical data:

Peak operating voltage		[V]	300 Volt
Test voltage		[V] _{AC}	800
Temperature range	in motion		- 5°C till +50°C
	fixed		-30°C till +70°C
Bending radius	in motion	x diameter	15
Flammability	standard		EN 60332-1-2
Insulation resistance	min.	[M Ω /km]	100
Mutal capacitance		[Ω /km]	73,2
	max.	[nF/km]	100

Number of cores and nominal conductor diameter mm ²	Price	Copper figure kg/km	Insulation thickness mm	Overall diameter appr. mm	Weight appr. kg / km
	EUR / km				
2 x 0,8	507,96	10	1,1	5,2	35
3 x 0,8	614,39	15	1,1	5,5	44
4 x 0,8	743,81	20	1,1	5,9	51

JB-Y(ST)Y Fire Alarm Cable

Application: They are suitable for fixed installation indoors and are used for fire alarm systems.

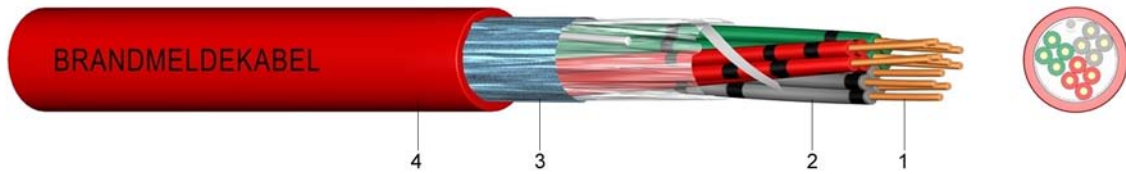

Construction:

- 1 solid bare copper, Ø 0,8mm
- 2 core insulation of polyvinylchloride (PVC)
- 3 static screen of plastic coated aluminium foil with a drain wire
- 4 outer sheath of polyvinylchloride (PVC), red with the marking "BRANDMELDEKABEL" (fire alarm cable)

Standards: DIN VDE 0815 (core identification)
DIN EN 60228 class 1 (construction)

Technical data:

Peak operating voltage		[V]	300 Volt
Test voltage at 50 Hz	core / core	[V] _{AC}	800
	core / screen	[V] _{AC}	800
Temperature range	in motion		- 5°C till +50°C
	fixed		-30°C till +70°C
Bending radius	in motion	x diameter	15
Flammability	standard		EN 60332-1-2
Insulation resistance	min.	[MΩ/km]	100
Mutal capacitance		[Ω/km]	73,2
	max.	[nF/km]	100

Number of cores and nominal conductor diameter mm ²	Price EUR / km	Copper figure kg/km	Insulation thickness mm	Overall diameter appr. mm	Weight appr. kg / km
1 x 2 x 0,8	831,85	11	1,1	5,5	38
2 x 2 x 0,8	929,78	21	1,1	6,1	54
4 x 2 x 0,8	1.596,08	41	1,1	8,7	94
5 x 2 x 0,8	2.177,12	52	1,1	9,4	114
6 x 2 x 0,8	2.464,47	62	1,1	10,1	135
10 x 2 x 0,8	3.208,04	103	1,3	13,1	205
12 x 2 x 0,8	4.136,22	123	1,3	13,5	235
20 x 2 x 0,8	5.433,42	203	1,3	15,6	352
30 x 2 x 0,8	8.374,17	304	1,5	19,4	522
40 x 2 x 0,8	10.802,57	404	1,5	20,9	663
50 x 2 x 0,8	13.366,14	505	1,7	23,7	832

F-vYAY

Installation Cable for Telecommunication

Application:

They are suitable for fixed installation indoors and are used for telecommunication purposes.

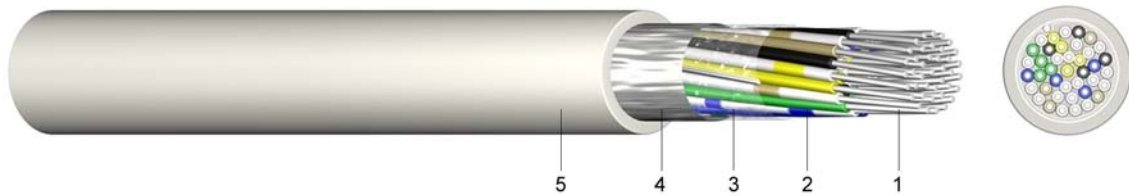

Construction:

- 1 solid bare copper, \varnothing 0,5mm
- 2 core insulation of polyvinylchloride (PVC)
- 3 cores are stranded in concentric layers
- 4 static screen of aluminium foil
- 5 outer sheath of polyvinylchloride (PVC), grey

Standards:

according to ÖVE K35 - 1997 (core identification)

Technical data:

Peak operating voltage		[V]	200 Veff / 300 Volt
Test voltage at 50 Hz	core / core	[V] _{AC}	500
	core / screen	[V] _{AC}	2000
Temperature range	in motion		- 5°C till +50°C
	fixed		-30°C till +70°C
Bending radius	in motion	x diameter	15
Flammability	standard		EN 60332-2-2
Insulation resistance	min.	[M Ω /km]	500
Mutal capacitance		[Ω /km]	195,6
	max.	[nF/km]	100
Capacitance unbalance 100m	max	[pF]	500

Number of pairs and nominal conductor diameter mm	Price EUR / km	Copper figure kg/km	Insulation thickness mm	Overall diameter appr. mm	Weight appr. kg / km
2 x 2 x 0,5	812,38	10	1,0	4,8	28
3 x 2 x 0,5	908,94	14	1,0	5,2	33
5 x 2 x 0,5	1.274,10	22	1,0	5,8	46
6 x 2 x 0,5	1.607,01	25	1,0	6,3	53
10 x 2 x 0,5	1.945,76	41	1,0	7,7	77
15 x 2 x 0,5	2.502,80	61	1,0	9,0	107
20 x 2 x 0,5	3.299,36	80	1,2	9,2	130
30 x 2 x 0,5	4.685,37	120	1,2	10,7	185
40 x 2 x 0,5	5.985,35	159	1,2	12,7	245
50 x 2 x 0,5	7.047,49	198	1,4	14,3	300
60 x 2 x 0,5	8.355,71	237	1,4	15,2	350
100 x 2 x 0,5	13.586,15	396	1,6	19,5	555

F-YAY

Installation Cable for Telecommunication

Application: They are suitable for fixed installation indoors and are used for telecommunication purposes.

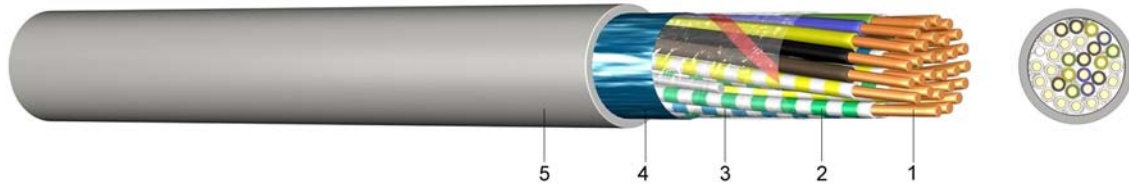

Construction:

- 1 solid bare copper \varnothing 0,6/0,8mm
- 2 core insulation of polyvinylchloride (PVC)
- 3 layer of plastic foil with copper drain wire
- 4 static screen of plastic laminated aluminium foil
- 5 outer sheath of polyvinylchloride (PVC), grey

Information: conductor loop resistance:

core- \varnothing 0,6mm <135,8 Ohm/km
 core- \varnothing 0,8mm < 73,2 Ohm/km

Standards: according to ÖVE K35 - 1997 (core identification)
 Flammability standard EN 60332-1-2 and 2-2

Technical data:

Peak operating voltage		[V]	200Veff / 300 Volt
Test voltage at 50 Hz	core / core	[V] _{Ac}	500
	core / screen	[V] _{Ac}	2000
Temperature range	in motion		- 5°C till +50°C
	fixed		-30°C till +70°C
Bending radius	in motion	x diameter	15
Insulation resistance	min.	[M Ω /km]	500
Mutal capacitance	max.	[nF/km]	100
Capacitance unbalance 100m	max	[pF]	500

Number of pairs and nominal conductor diameter mm	Price EUR / km	Copper figure kg/km	Insulation thickness mm	Overall diameter appr.mm	Weight appr. kg / km
2 x 2 x 0,6	838,90	13	1,0	5,2	36
3 x 2 x 0,6	988,55	19	1,0	5,7	44
5 x 2 x 0,6	1.384,48	30	1,0	6,6	65
6 x 2 x 0,6	1.598,78	36	1,0	7,1	70
10 x 2 x 0,6	2.222,33	59	1,0	8,7	102
15 x 2 x 0,6	2.881,30	87	1,0	10,5	140
20 x 2 x 0,6	3.651,98	115	1,2	10,8	175
25 x 2 x 0,6	4.639,33	140	1,2	12,0	225
30 x 2 x 0,6	5.355,54	172	1,2	12,5	260
40 x 2 x 0,6	6.741,71	228	1,2	14,5	335
50 x 2 x 0,6	8.332,90	285	1,4	16,4	410
60 x 2 x 0,6	9.732,12	342	1,4	17,8	500
100 x 2 x 0,6	16.563,57	568	1,6	23,1	810

Number of pairs and nominal conductor diameter mm	Price EUR / km	Copper figure kg/km	Insulation thickness mm	Overall diameter appr.mm	Weight appr. kg / km
2 x 2 x 0,8	1.445,19	21	1,0	7,1	56
3 x 2 x 0,8	1.610,55	32	1,0	7,4	69
5 x 2 x 0,8	2.108,80	52	1,0	8,8	101
6 x 2 x 0,8	2.418,85	62	1,0	10,2	140
10 x 2 x 0,8	3.555,77	103	1,2	12,4	170
20 x 2 x 0,8	5.989,27	203	1,2	15,2	330
30 x 2 x 0,8	8.716,15	304	1,4	17,8	485
40 x 2 x 0,8	11.998,09	404	1,4	20,5	670
50 x 2 x 0,8	15.001,51	505	1,6	24,5	800
100 x 2 x 0,8	29.559,81	1.008	1,8	33,9	1.540

J-Y(ST)Y

Installation Cable for Telecommunication

Application:

They are suitable for fixed installation indoors and are used for telecommunication purposes.

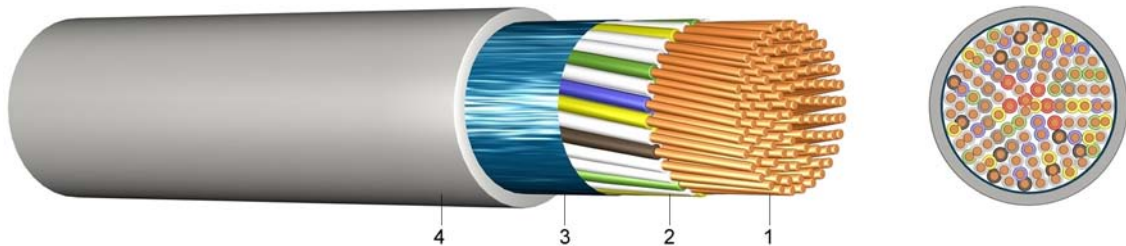

Construction:

- 1 solid bare copper \varnothing 0,6/0,8mm
- 2 core insulation of polyvinylchloride (PVC)
- 3 static screen of plastic laminated aluminium foil with drain wire
- 4 outer sheath of polyvinylchloride (PVC), grey

Information:

conductor loop resistance:
 core- \varnothing 0,6mm 130,0 Ohm/km
 core- \varnothing 0,8mm 73,2 Ohm/km

Standards:

DIN VDE 0815 (core identification)
 DIN EN 60228 class 1 (construction)
 Flammability standard EN 60332-1-2 and 2-2

Technical data:

Peak operating voltage		[V]	300 Volt
Test voltage at 50 Hz	core / core	[V] _{AC}	800
	core / screen	[V] _{AC}	800
Temperature range	in motion		- 5°C till +50°C
	fixed		-30°C till +70°C
Bending radius	in motion	x diameter	15
Insulation resistance	min.	[M Ω /km]	100
Mutal capacitance	max.	[nF/km]	10
Capacitance unbalance 100m	max	[pF]	300

Number of pairs and nominal conductor diameter mm	Price EUR / km	Copper figure kg/km	Insulation thickness mm	Overall diameter appr. mm	Weight appr. kg / km
1 x 2 x 0,6	501,04	7	1,1	4,5	26
2 x 2 x 0,6	560,03	13	1,1	4,9	35
3 x 2 x 0,6	806,42	19	1,1	6,2	49
4 x 2 x 0,6	956,45	24	1,1	6,6	58
5 x 2 x 0,6	1.203,00	30	1,1	7,1	59
6 x 2 x 0,6	1.343,76	36	1,1	7,6	61
10 x 2 x 0,6	1.784,19	59	1,1	9,3	113
12 x 2 x 0,6	2.114,10	72	1,1	9,5	129
20 x 2 x 0,6	3.212,89	116	1,1	10,9	191
30 x 2 x 0,6	4.580,58	172	1,3	13,7	284
40 x 2 x 0,6	5.911,45	228	1,3	14,5	358
50 x 2 x 0,6	7.266,45	285	1,3	16,5	438
60 x 2 x 0,6	8.489,37	342	1,3	17,5	512
100 x 2 x 0,6	13.481,40	568	1,5	22,1	829

Number of pairs and nominal conductor diameter mm	Price EUR / km	Copper figure kg/km	Insulation thickness mm	Overall diameter appr.mm	Weight appr. kg / km
1 x 2 x 0,8	665,49	11	1,1	5,5	38
2 x 2 x 0,8	743,83	21	1,1	6,1	54
3 x 2 x 0,8	1.097,48	31	1,1	8,0	77
4 x 2 x 0,8	1.276,87	41	1,1	8,7	94
5 x 2 x 0,8	1.741,69	52	1,1	9,4	114
6 x 2 x 0,8	1.971,56	62	1,1	10,1	135
10 x 2 x 0,8	2.566,44	103	1,3	13,1	205
12 x 2 x 0,8	3.308,98	123	1,3	13,5	235
16 x 2 x 0,8	4.059,73	164	1,3	14,8	299
20 x 2 x 0,8	4.346,73	203	1,3	15,6	352
30 x 2 x 0,8	6.699,33	304	1,5	19,4	522
40 x 2 x 0,8	8.642,03	404	1,5	20,9	663
50 x 2 x 0,8	10.692,92	505	1,7	23,7	832
60 x 2 x 0,8	12.531,66	606	1,7	25,8	978

YYSch

PVC Insulated Telecommunication Cable

Application:

For indoor installation in conduits, cable ducts or on the wall surface. This cable is suitable for the application in intercom communicators but not admissible in heavy current installations.



Construction:

- 1 solid bare copper
- 2 core insulation of polyvinylchloride (PVC)
- 3 outer sheath of polyvinylchloride (PVC), ivory or grey

Standards:

according to Factory standard

Technical data:

Peak operating voltage		[V]	65 Volt eff.
Test voltage		[V] _{AC}	500
Temperature range	in motion		+5°C till +50°C
Bending radius	in motion	x diameter	15
Flammability	standard		EN 60332-2-2
Insulation resistance	min.	[MΩm/km]	50
Conductor resistance	max.	[Ωm/km]	65

Number of cores and nominal conductor diameter mm ²	Price EUR / km	Copper figure kg/km	Overall diameter appr. mm	Weight appr. kg / km
2 x 0,6	206,82	5,6	3,0	12
3 x 0,6	249,15	8,4	3,2	16
4 x 0,6	316,87	11,2	3,4	20
5 x 0,6	492,24	14,0	3,7	26
6 x 0,6	585,38	16,8	4,0	29
10 x 0,6	1.098,17	28,0	6,0	54
16 x 0,6	1.540,83	45,0	6,8	78
26 x 0,6	2.514,43	72,8	8,2	110

YR

PVC Insulated Telecommunication Cable

Application:

For indoor installation in conduits, cable ducts or on the wall surface. This cable is suitable for the application in intercom communicators but not admissible in heavy current installations.



Construction:

- 1 solid bare copper
- 2 core insulation of polyvinylchloride (PVC)
- 3 outer sheath of polyvinylchloride (PVC), white

Standards:

according to Factory standard

Technical data:

Peak operating voltage		[V]	100 Volt
Test voltage		[V] _{AC}	1000
Temperature range	in motion		+5°C till +50°C
Bending radius	in motion	x diameter	15
Flammability	standard		EN 60332-1-2

Number of cores and nominal cross section mm ²	Price	Copper figure	Overall diameter	Weight
	EUR / km	kg/km	appr.mm	appr. kg / km
2 x 0,8	472,40	10	3,7	24
3 x 0,8	571,94	15	4,0	30
4 x 0,8	691,90	20	4,3	36
5 x 0,8	912,93	25	4,7	44
6 x 0,8	973,93	30	5,0	52
10 x 0,8	1.503,66	50	7,2	92

F-vYDvY

Telephone Modem Cable BTX Cable

Application:

For fixed installations in all types of plants with interference and radiation hazard of the audio and communication engineering. It is used as a data connection cable as well as a modem cable.

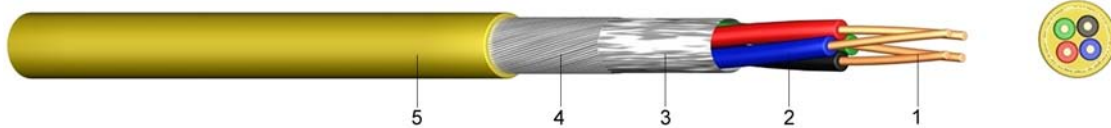

Construction:

- 1 solid tinned copper
- 2 core insulation of polyvinylchloride (PVC)
- 3 layer of plastic foil
- 4 twisted braid of tinned copper wires
- 5 outer sheath of polyvinylchloride (PVC), yellow

Standards:

adapted to ÖVE-K50 / 1984

Technical data:

Peak operating voltage		[V]	300 Volt eff.
Temperature range	in motion		-5°C till +70°C
Flammability	standard		EN 60332-2-2
Impedance	0,1-2 Mhz	[Ohm]	850,0
Mutal capacitance	max.	[nF/km]	120
Capacitance unbalance 100m	max	[pF]	500
Aderwiderstand		[Ohm x km]	98,0

Number of cores and nominal conductor diameter mm ²	Price	Copper figure	Overall diameter	Weight
	EUR / km	kg/km	appr.mm	appr. kg / km
4 x 0,5/1	693,03	21	4,0	31

F-2YA2Y

Plastic Insulated Telecommunication Cable for Local Networks

Application:

They are suitable for the installation into the earth, in conduits, cable ducts and are used as network cables in industrial and operational plants, mainly in low-frequency installations.

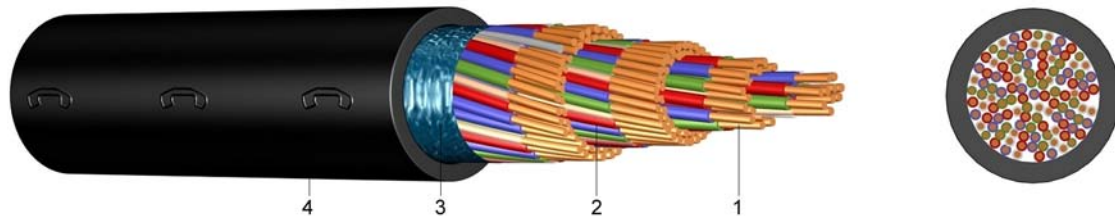

Construction:

- 1 solid bare copper, \varnothing 0,6/0,8mm
- 2 core insulation of polyethylene (PE)
- 3 static screen of aluminium foil with tinned copper drain wire, \varnothing 0,5mm
- 4 outer sheath of polyethylene (PE), black

Information:

conductor loop resistance:
 core- \varnothing 0,6mm 130,0 Ohm/km
 core- \varnothing 0,8mm 73,2 Ohm/km
 Cores twisted to star-quads.
 Core colours: transparent (or black by the start quad), red, green, blue

Standards:

adapted to austrian telecom standard

Technical data:

Peak operating voltage		[V]	200Veff / 300 Volt
Test voltage at 50 Hz	core / core	[V] _{AC}	500
	core / screen	[V] _{AC}	2000
Temperature range	in motion		-20°C till +90°C
Bending radius	in motion	x diameter	15
Insulation resistance	min.	[M Ω /km]	10000
Mutal capacitance	max.	[nF/km]	55
Capacitance unbalance 100m	max	[pF]	1500

Number of pairs and nominal conductor diameter mm	Price EUR / km	Copper figure kg/km	Insulation thickness mm	Overall diameter appr. mm	Weight appr. kg / km
2 x 2 x 0,6	1.135,67	13	1,8	7,1	46
6 x 2 x 0,6	2.133,46	36	1,8	9,3	86
10 x 2 x 0,6	2.913,54	59	1,8	10,5	120
20 x 2 x 0,6	4.333,42	115	1,8	14,2	210
30 x 2 x 0,6	5.707,36	172	1,8	16,5	280
40 x 2 x 0,6	7.197,39	228	1,8	17,0	355
50 x 2 x 0,6	8.417,71	285	1,8	18,5	425
60 x 2 x 0,6	9.739,63	342	1,8	19,5	485
100 x 2 x 0,6	14.727,38	568	2,0	26,5	820

Number of pairs and nominal conductor diameter mm	Price EUR / km	Copper figure kg/km	Insulation thickness mm	Overall diameter appr.mm	Weight appr. kg / km
2 x 2 x 0,8	1.920,60	22	1,8	7,6	65
6 x 2 x 0,8	3.082,86	62	1,8	10,4	130
10 x 2 x 0,8	4.222,16	103	1,8	12,2	190
20 x 2 x 0,8	6.772,87	203	1,8	16,4	330
30 x 2 x 0,8	7.999,24	304	1,8	18,2	460
40 x 2 x 0,8	10.207,68	404	1,8	19,8	580
50 x 2 x 0,8	12.336,30	504	2,0	21,6	700
60 x 2 x 0,8	14.278,67	606	2,0	23,1	780
100 x 2 x 0,8	22.038,44	1.008	2,0	31,3	1.350

F-2YC2Y

Plastic Insulated Telecommunication Cable for Local Networks

Application:

They are suitable for the installation into the earth, in conduits, cable ducts and are used as network cables in industrial and operational plants, mainly in low-frequency installations.

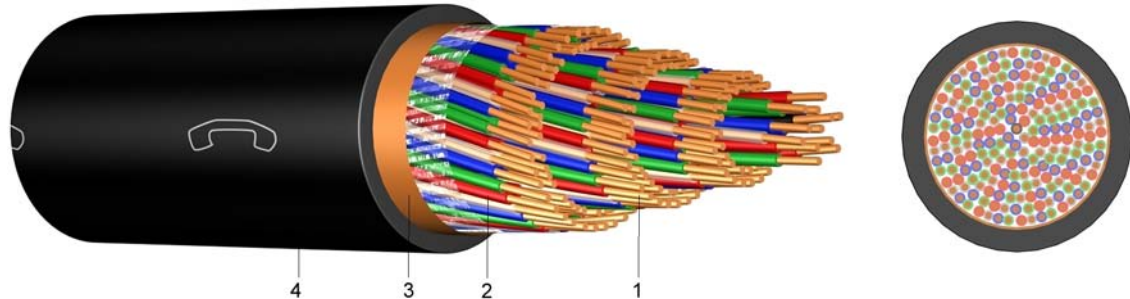

Construction:

- 1 solid bare copper, \varnothing 0,6/0,8mm
- 2 core insulation of polyethylene (PE)
- 3 static screen of copper tape
- 4 outer sheath of polyethylene (PE), black

Information:

conductor loop resistance:
 core- \varnothing 0,6mm 130,0 Ohm/km
 core- \varnothing 0,8mm 73,2 Ohm/km
 Cores twisted to star-quads.
 Core colours: transparent (or black by the start quad), red, green, blue

Standards:

adapted to austrian telecom standard

Technical data:

Peak operating voltage		[V]	200 Veff / 300 Volt
Test voltage at 50 Hz	core / core	[V] _{AC}	500
	core / screen	[V] _{AC}	2000
Temperature range	in motion		-20°C till +90°C
Bending radius	in motion	x diameter	15
Insulation resistance	min.	[M Ω /km]	10000
Mutal capacitance	max.	[nF/km]	55
Capacitance unbalance 100m	max	[pF]	1500

Number of pairs and nominal conductor diameter mm	Price EUR / km	Copper figure kg/km	Insulation thickness mm	Overall diameter appr. mm	Weight appr. kg / km
2 x 2 x 0,6	1.393,28	31,5	1,8	8,6	78
6 x 2 x 0,6	2.568,86	70,0	1,8	10,1	110
10 x 2 x 0,6	3.339,26	97,0	1,8	11,5	150
20 x 2 x 0,6	5.238,10	173,0	1,8	15,0	250
30 x 2 x 0,6	6.480,19	242,0	1,8	16,5	320
40 x 2 x 0,6	8.087,54	304,5	1,8	17,8	400
50 x 2 x 0,6	9.259,48	370,5	1,8	19,2	480
60 x 2 x 0,6	10.414,51	433,0	1,8	19,9	550
100 x 2 x 0,6	17.587,69	682,0	2,0	25,0	865

Number of pairs and nominal conductor diameter mm	Price EUR / km	Copper figure kg/km	Insulation thickness mm	Overall diameter appr.mm	Weight appr. kg / km
2 x 2 x 0,8	2.236,36	50,0	1,8	8,3	95
6 x 2 x 0,8	3.631,88	104,5	1,8	11,5	150
10 x 2 x 0,8	4.749,42	160,0	1,8	13,0	205
20 x 2 x 0,8	7.506,82	279,0	1,8	17,5	360
30 x 2 x 0,8	9.134,56	392,0	1,8	19,5	485
40 x 2 x 0,8	11.380,72	500,5	1,8	21,0	605
50 x 2 x 0,8	13.412,37	614,5	2,0	23,0	732
60 x 2 x 0,8	16.502,17	725,0	2,0	23,6	865
100 x 2 x 0,8	23.435,72	1.161,0	2,0	33,0	1.390

F-2YJA2Y

Plastic Insulated Telecommunication Cable for Local Networks, transversely and longitudinally water-proof

Application:

They are suitable for the installation into the earth, in conduits, cable ducts and are used as network cables in industrial and operational plants, mainly in low-frequency installations.

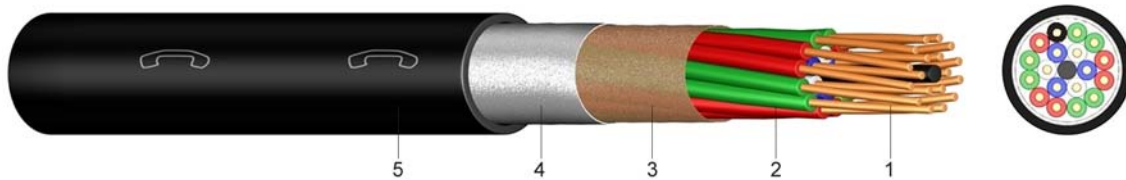

Construction:

- 1 solid bare copper, \varnothing 0,6/0,8mm
- 2 core insulation of polyethylene (PE)
- 3 the interstices of the cable are filled with jelly, one layer of plastic foil
- 4 screen of plastic laminated aluminium foil
- 5 outer sheath of polyethylene (PE), black

Information:

conductor loop resistance:
 core- \varnothing 0,6mm 130,0 Ohm/km
 core- \varnothing 0,8mm 73,2 Ohm/km
 Cores twisted to star-quads.
 Core colours: transparent (or black by the start quad), red, green, blue

Standards:

adapted to austrian telecom standard

Technical data:

Peak operating voltage		[V]	200 V _{eff} / 300 Volt
Test voltage at 50 Hz	core / core	[V] _{AC}	500
	core / screen	[V] _{AC}	2000
Temperature range	in motion		-20°C till +90°C
Bending radius	in motion	x diameter	15
Insulation resistance	min.	[M Ω /km]	5000
Mutal capacitance	max.	[nF/km]	52
Capacitance unbalance 100m	max	[pF]	300

Number of pairs and nominal conductor diameter mm	Price EUR / km	Copper figure kg/km	Insulation thickness mm	Overall diameter appr. mm	Weight appr. kg / km
6 x 2 x 0,6	2.245,94	36	1,8	11,0	125
10 x 2 x 0,6	3.208,65	59	1,8	12,5	170
20 x 2 x 0,6	4.614,02	115	1,8	16,5	310
30 x 2 x 0,6	5.937,14	172	1,8	18,0	390
50 x 2 x 0,6	8.537,45	285	1,8	22,0	580
100 x 2 x 0,6	15.306,69	568	2,0	30,0	1.150

Number of pairs and nominal conductor diameter mm	Price EUR / km	Copper figure kg/km	Insulation thickness mm	Overall diameter appr.mm	Weight appr. kg / km
6 x 2 x 0,8	3.520,69	62	1,8	12,5	170
10 x 2 x 0,8	4.572,90	103	1,8	14,0	234
20 x 2 x 0,8	7.431,92	203	1,8	19,5	450
30 x 2 x 0,8	8.994,72	304	1,8	21,5	600
50 x 2 x 0,8	13.324,42	504	2,0	26,5	920
60 x 2 x 0,8	14.149,65	606	2,0	31,0	1.240

A-2Y(L)2Y

Plastic Insulated Telecommunication Cable for Local Networks

Application:

Suitable for the installation into the earth, in conduits, cable ducts and are used as network cables in industrial and operational plants, mainly in LF-installations.

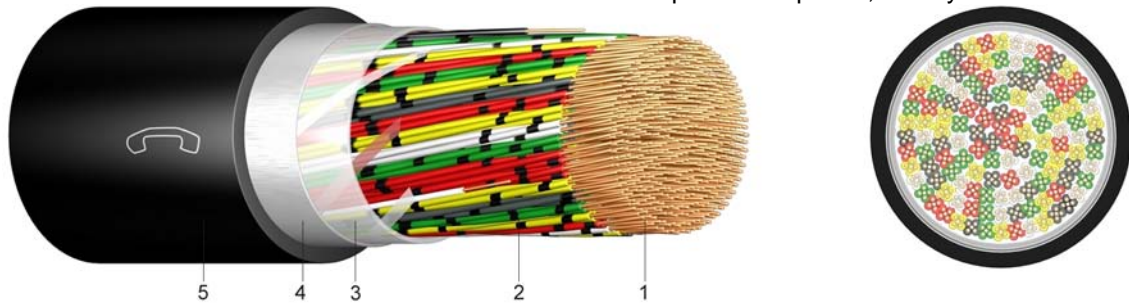

Construction:

- 1 solid bare copper, \varnothing 0,6/0,8mm
- 2 core insulation of polyethylene (PE)
- 3 layer of plastic foil
- 4 static screen of plastic laminated aluminium tape
- 5outer sheath of polyethylene (PE), black

Information:

conductor loop resistance:
 core- \varnothing 0,6mm 130,0 Ohm/km
 core- \varnothing 0,8mm 73,2 Ohm/km
 Cores twisted to star-quads.

Standards:

DIN VDE 0816 (core identification)
 DIN EN 60228 class 1 (construction)

Technical data:

Peak operating voltage		[V]	225 Volt
Test voltage at 50 Hz	core / core	[V] _{AC}	500
	core / screen	[V] _{AC}	2000
Temperature range	in motion		-20°C till +50°C
	fixed		-20°C till +70°C
Bending radius	in motion	x diameter	15
Insulation resistance	min.	[M Ω /km]	5000
Mutal capacitance	max.	[nF/km]	52
Capacitance unbalance 100m	max	[pF]	800

Number of pairs and nominal conductor diameter mm	Price EUR / km	Copper figure kg/km	Insulation thickness mm	Overall diameter appr. mm	Weight appr. kg / km
2 x 2 x 0,6	1.633,69	13	1,8	8,1	63
6 x 2 x 0,6	2.133,46	36	1,8	9,3	86
10 x 2 x 0,6	3.045,10	59	1,8	11,5	146
20 x 2 x 0,6	4.569,34	115	1,8	15,2	239
40 x 2 x 0,6	7.132,52	228	1,8	18,0	391
50 x 2 x 0,6	8.206,09	285	1,8	19,4	469
100 x 2 x 0,6	13.334,39	568	2,0	27,9	878
2 x 2 x 0,8	2.053,46	22	1,8	8,6	74
6 x 2 x 0,8	3.080,92	62	1,8	11,3	141
10 x 2 x 0,8	4.011,94	103	1,8	13,2	203
20 x 2 x 0,8	6.037,34	203	1,8	17,3	346
40 x 2 x 0,8	9.403,58	404	2,0	20,7	590
50 x 2 x 0,8	11.157,15	505	2,0	22,5	715

A-2YF(L)2Y

Plastic Insulated Telecommunication Cable for Local Networks, transver. and longitud.water-proof

Application:

Suitable for the installation into the earth, in conduits, cable ducts and are used as network cables in industrial and operational plants, mainly in LF-installations.

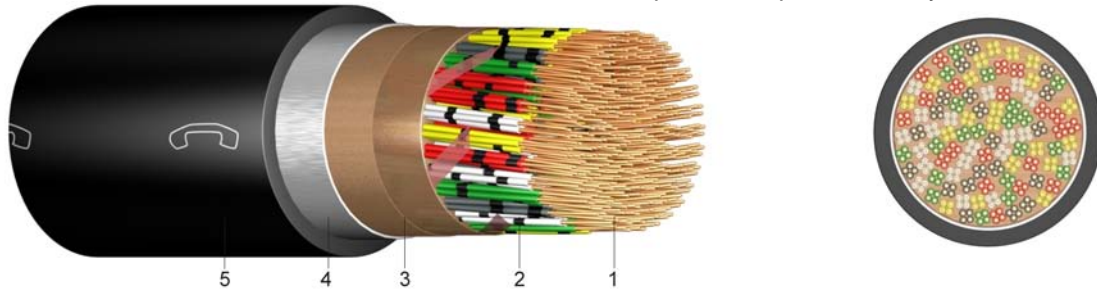

Construction:

- 1 solid bare copper, \varnothing 0,6/0,8mm
- 2 core insulation of polyethylene (PE)
- 3 the interstices of the cable are continuously filled with jelly, layer of plastic foil
- 4 static screen of plastic laminated aluminium tape
- 5 outer sheath of polyethylene (PE), black

Information:

conductor loop resistance:
 core- \varnothing 0,6mm 130,0 Ohm/km
 core- \varnothing 0,8mm 73,2 Ohm/km
 Cores twisted to star-quads.

Standards:

DIN VDE 0816 (core identification)
 DIN EN 60228 class 1 (construction)

Technical data:

Peak operating voltage		[V]	225 Volt
Test voltage at 50 Hz	core / core	[V] _{AC}	500
	core / screen	[V] _{AC}	2000
Temperature range	in motion		-20°C till +50°C
	fixed		-20°C till +70°C
Bending radius	in motion	x diameter	15
Insulation resistance	min.	[M Ω m/km]	1500
Mutal capacitance	max.	[nF/km]	52
Capacitance unbalance 100m	max	[pF]	800

Number of pairs and nominal conductor diameter mm	Price EUR / km	Copper figure kg/km	Insulation thickness mm	Overall diameter appr.mm	Weight appr. kg / km
2 x 2 x 0,6	1.976,09	13	1,8	8,3	67
6 x 2 x 0,6	2.919,92	36	1,8	11,0	126
10 x 2 x 0,6	3.726,21	59	1,8	12,5	171
20 x 2 x 0,6	5.459,94	115	1,8	15,8	287
30 x 2 x 0,6	7.057,82	172	1,8	19,0	409
40 x 2 x 0,6	8.406,21	228	1,8	20,4	503
50 x 2 x 0,6	9.734,23	285	1,8	22,2	606
100 x 2 x 0,6	16.655,46	568	2,0	30,3	1.155
2 x 2 x 0,8	2.452,36	22	1,8	8,8	83
4 x 2 x 0,8	3.030,18	41	1,8	11,2	134
6 x 2 x 0,8	3.608,11	62	1,8	12,0	165
10 x 2 x 0,8	4.827,36	103	1,8	14,0	232

Number of pairs and nominal conductor diameter mm	Price EUR / km	Copper figure kg/km	Insulation thickness mm	Overall diameter appr.mm	Weight appr. kg / km
20 x 2 x 0,8	7.447,30	203	1,8	19,1	445
30 x 2 x 0,8	9.645,85	304	1,8	22,0	588
40 x 2 x 0,8	12.087,22	404	2,0	24,0	748
50 x 2 x 0,8	13.972,17	505	2,0	26,0	910
100 x 2 x 0,8	24.275,66	1.008	2,2	36,0	1.787
150 x 2 x 0,8	35.684,16	1.512	2,2	42,2	2.553

RG 58 C/U Coaxial Cable 50 Ohm

Application: For indoor installation as well as in industrial areas in conduits and cable ducts, for transmission of high frequency signals and power.



Construction:

- 1 fine-stranded tinned copper construction: 19 x 0,75mm
- 2 core insulation of polyethylene (PE) Ø ca. 2,95mm
- 3 screen of tinned copper braiding
- 4 outer sheath of polyvinylchloride (PVC), black

Information: For underground laying PE outer sheath. Special plastic in the halogen-free version.

Standards: according to US Standard MIL -C - 17

Technical data:

Temperature range	in motion		-5°C till +70°C
Frequency range	F max	[GHz]	3,0
Insulation resistance	R iso	[MΩm/km]	10000
Impedance	ZL	[Ωm]	50 +/-2
Attenuation	100 MHz	[dB / 100m]	15,3
Capacitance	C	[NF / km]	100
Rel. velocity ratio	V rel	%	67,0
Electric strength	50Hz	[KV]eff	5
Bending radius	min.	[mm]	25
Operating peak voltage		[kV]	2,5

Type	Price EUR / km	Copper figure kg/km	Overall diameter appr.mm	Weight appr. kg / km
RG 58 C/U	1.057,05	19	5,0	35
RG 58 C/U for underground laying	1.270,39	19	5,0	35
RG 58 C/U halogen free	2.230,89	19	5,0	35

RG 59 B/U Coaxial Cable 75 Ohm

Application: For indoor installation as well as in industrial areas in conduits and cable ducts, for transmission of high frequency signals and power.



Construction:

- 1 copper-platinated steel
Ø ca. 0,584mm
- 2 core insulation of polyethylene (PE)
Ø ca. 3,7mm
- 3 screen of bare copper braiding
- 4 outer sheath of polyvinylchloride (PVC), black

Information: For underground laying PE outer sheath.
Special plastic in the halogen-free version.

Standards: according to US Standard MIL -C - 17

Technical data:

Temperature range	in motion		-5°C till +70°C
Frequency range	F max	[GHz]	3,0
Insulation resistance	R iso	[MΩm/km]	10000
Impedance	ZL	[Ωm]	75 +/-3
Conductor loop-resistance		[Ωm/km]	180,0
Attenuation	100 MHz	[dB / 100m]	11,1
Capacitance	C	[NF / km]	67
Rel. velocity ratio	V rel	%	67,0
Electric strength	50Hz	[KV]eff	7
Bending radius	min.	[mm]	30
Operating peak voltage		[kV]	3,5

Type	Price EUR / km	Copper figure kg/km	Overall diameter appr. mm	Weight appr. kg / km
RG 59 B/U	1.007,46	24	6,2	51
RG 59 B/U for underground laying	1.211,91	24	6,2	51
RG 59 B/U halogen free	2.127,68	24	6,2	51

RG 62 A/U Coaxial Cable 93 Ohm

Application: For indoor installation as well as in industrial areas in conduits and cable ducts, for transmission of high frequency signals and power.

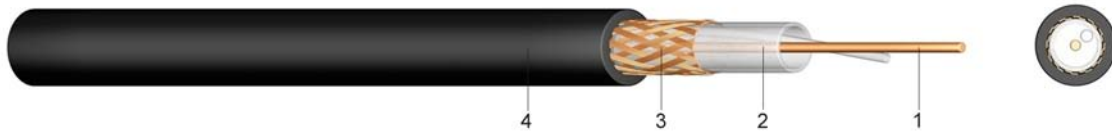

Construction:

- 1 copper-platinated steel (\varnothing ca. 0,64mm)
- 2 core insulation of polyethylene (PE)
 \varnothing ca. 3,7mm
- 3 screen of bare copper braiding
- 4 outer sheath of polyvinylchloride (PVC), black

Information: In the halogen-free version the outer sheath consists of a special halogen-free plastic.

Standards: according to US Standard MIL - C - 17

Technical data:

Temperature range	in motion		-5°C till +70°C
Frequency range	F max	[GHz]	3,0
Insulation resistance	R iso	[M Ω /km]	10000
Conductor loop-resistance		[Ω /km]	155,0
Attenuation	100 MHz	[dB / 100m]	9,0
Capacitance	C	[NF / km]	45
Rel. velocity ratio	V rel	%	83,0
Electric strength	50Hz	[KV]eff	3
Bending radius	min.	[mm]	30
Operating peak voltage		[kV]	1,1

Type	Price EUR / km	Copper figure kg/km	Overall diameter appr.mm	Weight appr. kg / km
RG 62 A/U	1.007,46	23	6,2	55
RG 62 A/U	2.127,68	23	6,2	55

RG 213 U Coaxial Cable 50 Ohm

Application: For indoor installation as well as in industrial areas in conduits and cable ducts, for transmission of high frequency signals and power.

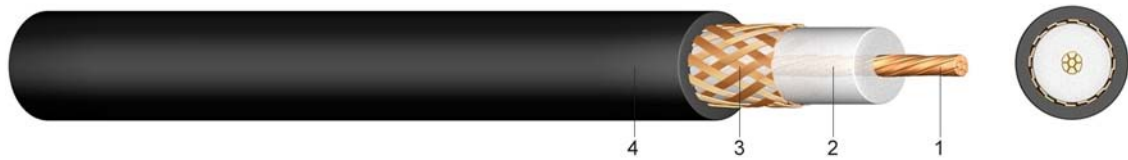

Construction:

- 1 stranded bare copper
construction: 7 x 0,75mm
- 2 core insulation of polyethylene (PE)
Ø ca. 7,3mm
- 3 screen of bare copper braiding
- 4 outer sheath of polyvinylchloride (PVC), black

Standards: according to US Standard MIL - C - 17

Technical data:

Temperature range	in motion		-5°C till +70°C
Frequency range	F max	[GHz]	3,0
Insulation resistance	R iso	[MΩm/km]	10000
Impedance	ZL	[Ωm]	50 +/-2
Attenuation	100 MHz	[dB / 100m]	6,8
Capacitance	C	[NF / km]	100
Rel. velocity ratio	V rel	%	67,0
Electric strength	50Hz	[KV]eff	10
Bending radius	min.	[mm]	50
Operating peak voltage		[kV]	5,2

Type	Price EUR / km	Copper figure kg/km	Overall diameter appr.mm	Weight appr. kg / km
RG 213 U	2.432,19	76	10,3	154

RG 11 A/U Coaxial Cable 75 Ohm

Application: For indoor installation as well as in industrial areas in conduits and cable ducts, for transmission of high frequency signals and power.

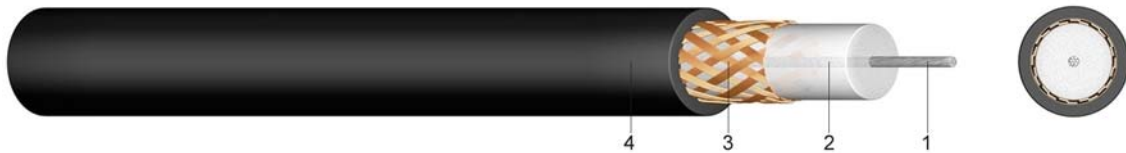

Construction:

- 1 stranded tinned copper
construction: 7 x 0,40mm
- 2 core insulation of polyethylene (PE)
Ø ca. 7,3mm
- 3 screen of bare copper braiding
- 4 outer sheath of polyvinylchloride (PVC) or halogen-free polymere, black

Standards: according to US Standard MIL - C - 17

Technical data:

Temperature range	in motion		-5°C till +70°C
Frequency range	F max	[GHz]	3,0
Insulation resistance	R iso	[MOhm/km]	10000
Attenuation	100 MHz	[dB / 100m]	7,7
Capacitance	C	[NF / km]	67
Rel. velocity ratio	V rel	%	67,0
Electric strength	50Hz	[KV]eff	10
Bending radius	min.	[mm]	50
Operating peak voltage		[kV]	5,2

Type	Price EUR / km	Copper figure kg/km	Overall diameter appr.mm	Weight appr. kg / km
RG 11 A/U	2.571,28	56	10,2	125
RG 11 A/U halogen free	4.530,56	56	10,2	125

RG 214 U Coaxial Cable 50 Ohm

Application: For indoor installation as well as in industrial areas in conduits and cable ducts, for transmission of high frequency signals and power.

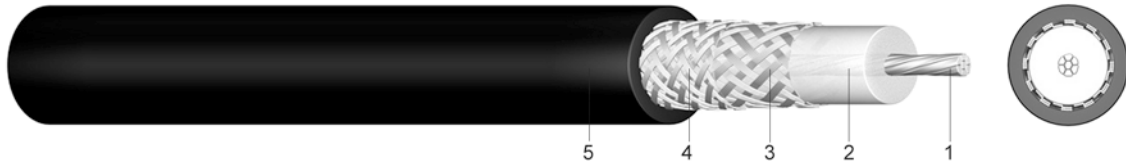

Construction:

- 1 stranded silvered copper
construction: 7 x 0,75mm
- 2 core insulation of polyethylene (PE)
Ø ca. 7,25mm
- 3 screen of silvered copper braiding
- 4 screen of silvered copper braiding
- 5 outer sheath of polyvinylchloride (PVC), black

Standards: according to US Standard MIL - C - 17

Technical data:

Temperature range	in motion		-5°C till +70°C
Frequency range	F max	[GHz]	3,0
Impedance	ZL	[Ohm]	50 +/-2
Attenuation	100 MHz	[dB / 100m]	6,7
Capacitance	C	[NF / km]	100
Rel. velocity ratio	V rel	%	66,0
Electric strength	50Hz	[KV]eff	2
Bending radius	min.	[mm]	50

Type	Price EUR / km	Copper figure kg/km	Overall diameter appr.mm	Weight appr. kg / km
RG 214 U	6.948,77	118	10,8	195

2YCFGY

HF - Coaxial Cable 75 Ohm SAT - Conform

Application:

Suitable for applications in dry and humid locations as an aerial cable for community- and cable television networks. SAT-conform.

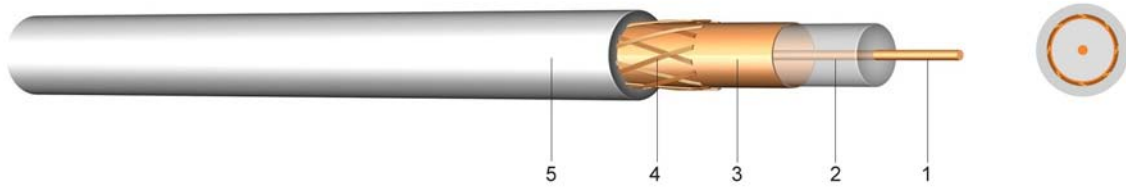

Construction:

- 1 solid bare copper
- 2 core insulation of polyethylene (PE)
- 3 static screen of copper foil
- 4 wide-meshed copper braiding
- 5 outer sheath of polyvinylchloride (PVC), white

Technical data:

	in motion		-5°C till +70°C
Temperature range	ZL	[Ohm]	75 +/-3
Impedance	100 MHz	[dB / 100m]	8,4
Attenuation	300 Mhz	[dB / 100m]	16,0
	450 Mhz	[dB / 100m]	19,5
	850 Mhz	[dB / 100m]	27,1
	DC resistance	inner conductor	[Ohm / km]
	outer conductor	[Ohm / km]	23,0
Bending radius	min.	[mm]	30
Shielding		[dB]	75,0

Type	Price	Copper figure	Overall diameter	Weight
	EUR / km	kg/km	appr.mm	appr. kg / km
2YCFGY 0,7/4,4	706,29	17,8	6,5	44
2YCFGY 0,7/4,6	881,37	17,8	6,8	46

2YALGY

HF - Coaxial Cable 75 Ohm SAT - Conform

Application:

Suitable for applications in dry and humid locations as an aerial cable for community- and cable television networks. SAT-conform.

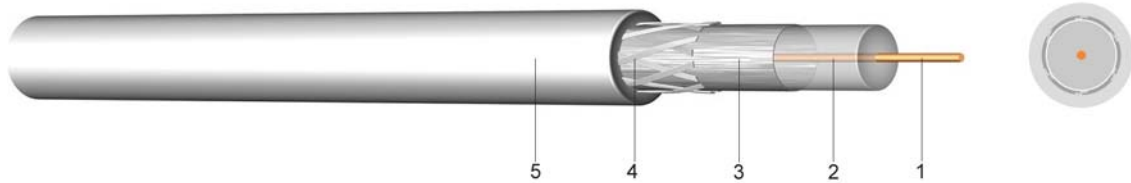

Construction:

- 1 solid bare copper
- 2 core insulation of polyethylene (PE)
- 3 static screen of aluminium foil
- 4 wide-meshed bare copper braiding
- 5 outer sheath of polyvinylchloride (PVC), white

Technical data:

	in motion		-5°C till +70°C
Temperature range			
Attenuation	100 MHz	[dB / 100m]	8,2
	300 Mhz	[dB / 100m]	15,7
	450 Mhz	[dB / 100m]	19,0
	850 Mhz	[dB / 100m]	26,7
DC resistance	inner conductor	[Ohm / km]	43,0
	outer conductor	[Ohm / km]	19,0
Bending radius	min.	[mm]	30

Type	Price EUR / km	Copper figure kg/km	Overall diameter appr. mm	Weight appr. kg / km
2YALGY 0,7/4,4 75 dB	706,29	17,8	6,5	44
2YALGY 1,1/5,0 100 dB digital	1.010,94	18,2	6,8	48

2YAFCY

HF - Coaxial Cable 75 Ohm SAT - Conform

Application:

Suitable for applications in dry and humid locations as an aerial cable for community- and cable television networks. SAT-conform.

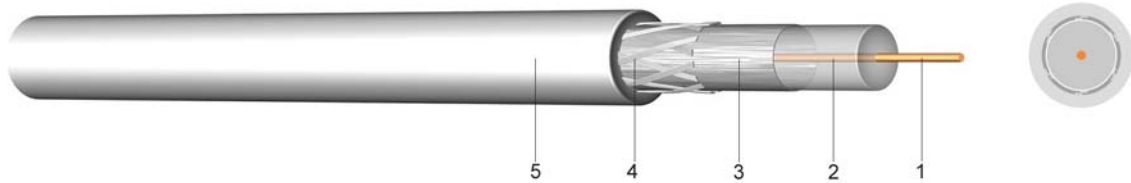

Construction:

- 1 solid bare copper
- 2 core insulation of polyethylene (PE)
- 3 static screen of aluminium foil
- 4 wide-meshed tinned copper braiding
- 5 outer sheath of polyvinylchloride (PVC), white

Technical data:

Temperature range	in motion		-5°C till +70°C
Impedance	ZL	[Ohm]	75 +/-3
Attenuation	100 MHz	[dB / 100m]	8,8
	300 Mhz	[dB / 100m]	15,0
	450 Mhz	[dB / 100m]	17,5
DC resistance	inner conductor	[Ohm / km]	131,0
	outer conductor	[Ohm / km]	20,0
Bending radius	min.	[mm]	30
Shielding		[dB]	75,0

Type	Price EUR / km	Copper figure kg/km	Overall diameter appr.mm	Weight appr. kg / km
2YAFCY 0,75/4,8	785,31	13	7,0	47

02YAFCY

HF - Coaxial Cable 75 Ohm SAT - Conform

Application:

Suitable for applications in dry and humid locations as an aerial cable for community- and cable television networks. SAT-conform.

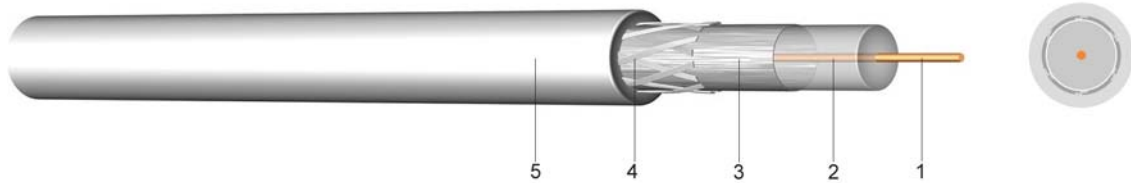

Construction:

- 1 solid bare copper
- 2 core insulation of polyethylene (PE)
- 3 static screen of aluminium foil
- 4 wide-meshed tinned copper braiding
- 5 outer sheath of polyvinylchloride (PVC), white

Technical data:

Impedance	ZL	[Ohm]	75 +/-3
Attenuation	100 MHz	[dB / 100m]	6,4
	300 Mhz	[dB / 100m]	11,1
	450 Mhz	[dB / 100m]	13,8
DC resistance	inner conductor	[Ohm / km]	131,0
	outer conductor	[Ohm / km]	20,0

Type	Price	Copper figure	Overall diameter	Weight
	EUR / km	kg/km	appr.mm	appr. kg / km
02YAFCY 1,0/4,5	948,07	14	6,5	44

DIGITAL 2000 Coaxial Cable Digital 90 db

Application: Suitable for applications in dry and humid locations as an aerial cable for community- and cable television networks. SAT-conform.

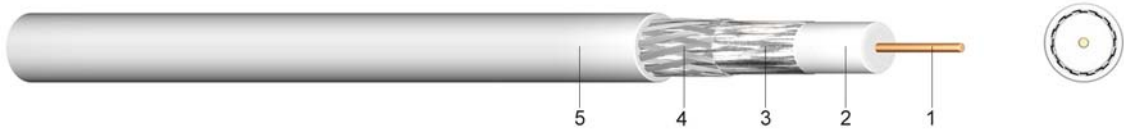

- Construction:**
- 1 solid bare copper, Ø ca. 1,0mm
 - 2 core insulation of polyethylene (PE) Ø ca. 4,6mm
 - 3 static screen of aluminium foil
 - 4 wide-meshed tinned copper braiding
 - 5 outer sheath of polyvinylchloride (PVC), white

Technical data:

Temperature range	in motion		-5°C till +70°C
Impedance	ZL	[Ohm]	75 +/-3
Attenuation	100 MHz	[dB / 100m]	6,8
	300 Mhz	[dB / 100m]	11,0
Capacitance	C	[NF / km]	55
DC resistance	inner conductor	[Ohm / km]	18,0
	outer conductor	[Ohm / km]	20,0
Bending radius	min.	[mm]	45
Shielding		[dB]	85,0

Type	Price	Copper figure	Overall diameter	Weight
	EUR / km	kg/km	appr.mm	appr. kg / km
DIGITAL 2000 90 dB	1.809,07	15,6	6,8	45

LiYY

Electronic Control Cable

Application:

To be installed in dry and humid rooms and used as a termination and connection cable in the control, measuring and signal technology.



Construction:

- 1 fine-stranded bare copper
- 2 core insulation of polyvinylchloride (PVC)
- 3 outer sheath of polyvinylchloride (PVC), grey

Information:

Peak operating voltage [V]:
 0,14 mm² ... 350 Volt
 all others ... 500 Volt
Test Voltage [V_{AC}]:
 0,14 mm² ... 800 Volt
 all others ... 1.200 Volt

Standards:

adapted to DIN VDE 0812
 DIN EN 60228 class 5 (construction)
 DIN 47100 or factory standard (core identification)

Technical data:

Temperature range	in motion		-5°C till +50°C
	fixed		-30°C till +70°C
Bending radius	in motion	x diameter	10
Flammability	standard		EN 60332-1-2
Insulation resistance	min.	[MΩm/km]	100

Number of cores and nominal cross section mm ²	Price EUR / km	Copper figure kg/km	Cond. construction (appr. value) mm	Conductor loop resistance Ohm/km	Overall diameter appr. mm	Weight appr. kg / km
2 x 0,14	277,18	2,8	18 x 0,10	138,0	3,2	12
3 x 0,14	381,64	4,2	18 x 0,10	138,0	3,4	15
4 x 0,14	442,92	5,6	18 x 0,10	138,0	3,6	17
5 x 0,14	540,29	7,0	18 x 0,10	138,0	3,9	22
6 x 0,14	617,63	8,4	18 x 0,10	138,0	4,2	25
7 x 0,14	649,27	9,8	18 x 0,10	138,0	4,2	26
8 x 0,14	848,16	11,2	18 x 0,10	138,0	4,5	29
10 x 0,14	997,40	14,0	18 x 0,10	138,0	5,2	35
12 x 0,14	1.146,38	16,8	18 x 0,10	138,0	5,6	43
16 x 0,14	1.427,87	22,4	18 x 0,10	138,0	6,1	52
18 x 0,14	1.560,59	25,2	18 x 0,10	138,0	6,9	65
21 x 0,14	1.850,21	29,4	18 x 0,10	138,0	6,9	79
24 x 0,14	2.081,67	33,6	18 x 0,10	138,0	7,6	89
30 x 0,14	2.517,96	42,0	18 x 0,10	138,0	8,0	106
2 x 0,25	398,26	5,0	14 x 0,16	75,5	3,8	25
3 x 0,25	469,10	7,5	14 x 0,16	75,5	4,0	29
4 x 0,25	585,06	10,0	14 x 0,16	75,5	4,3	31
5 x 0,25	656,14	12,5	14 x 0,16	75,5	4,7	38

Number of cores and nominal cross section mm²	Price EUR / km	Copper figure kg/km	Cond. construction (appr. value) mm	Conductor loop resistance Ohm/km	Overall diameter appr. mm	Weight appr. kg / km
6 x 0,25	681,72	15,0	14 x 0,16	75,5	5,1	42
7 x 0,25	798,27	17,5	14 x 0,16	75,5	5,4	48
8 x 0,25	1.078,12	20,0	14 x 0,16	75,5	5,7	54
10 x 0,25	1.335,98	25,0	14 x 0,16	75,5	6,8	65
12 x 0,25	1.593,74	30,0	14 x 0,16	75,5	7,0	75
16 x 0,25	1.897,66	40,0	14 x 0,16	75,5	7,7	95
18 x 0,25	2.063,17	45,0	14 x 0,16	75,5	8,3	101
24 x 0,25	2.870,28	60,0	14 x 0,16	75,5	9,4	143
30 x 0,25	3.318,66	75,0	14 x 0,16	75,5	10,3	172
36 x 0,25	3.895,47	90,0	14 x 0,16	75,5	11,1	196
2 x 0,34	414,90	6,8	19 x 0,16	57,5	4,2	28
3 x 0,34	523,65	10,2	19 x 0,16	57,5	4,4	30
4 x 0,34	634,27	13,6	19 x 0,16	57,5	4,8	40
5 x 0,34	785,93	17,0	19 x 0,16	57,5	5,5	44
7 x 0,34	964,13	23,8	19 x 0,16	57,5	5,9	60
10 x 0,34	1.570,12	34,0	19 x 0,16	57,5	7,6	77
12 x 0,34	1.741,34	40,8	19 x 0,16	57,5	7,8	97
16 x 0,34	2.120,17	54,4	19 x 0,16	57,5	8,7	114
18 x 0,34	2.442,24	61,2	19 x 0,16	57,5	9,1	135
24 x 0,34	3.183,40	81,6	19 x 0,16	57,5	11,0	171
36 x 0,34	4.271,86	122,4	19 x 0,16	57,5	12,5	244
2 x 0,5	458,63	10,0	16 x 0,21	37,8	4,7	25
3 x 0,5	589,25	15,0	16 x 0,21	37,8	5,0	35
4 x 0,5	762,21	20,0	16 x 0,21	37,8	5,6	42
5 x 0,5	1.068,58	25,0	16 x 0,21	37,8	6,1	49
7 x 0,5	1.179,66	35,0	16 x 0,21	37,8	6,9	73
10 x 0,5	1.795,54	50,0	16 x 0,21	37,8	8,6	120
12 x 0,5	1.942,10	60,0	16 x 0,21	37,8	8,9	130
16 x 0,5	2.499,24	80,0	16 x 0,21	37,8	10,2	152
18 x 0,5	2.787,81	90,0	16 x 0,21	37,8	10,2	159
24 x 0,5	3.830,10	120,0	16 x 0,21	37,8	12,5	250
36 x 0,5	5.286,35	180,0	16 x 0,21	37,8	14,5	315
3 x 0,75	728,48	22,5	24 x 0,21	25,3	5,6	64
5 x 0,75	1.193,04	37,5	24 x 0,21	25,3	6,9	77

LiYCY

Electronic Control Cable with Tinned Copper Braiding

Application:

To be installed in dry and humid rooms and used as a termination and connection cable in the control, measuring and signal technology.

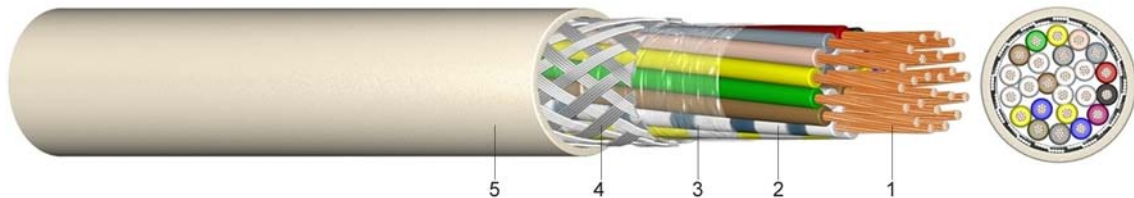

Construction:

- 1 fine-stranded bare copper
- 2 core insulation of polyvinylchloride (PVC)
- 3 layer of plastic foil
- 4 braid of tinned copper wires
- 5 outer sheath of polyvinylchloride (PVC), grey

Information:

Peak operating voltage [V]:

0,14 mm² ... 350 Volt
all others ... 500 Volt

Test Voltage [V_{AC}]:

0,14 mm² ... 800 Volt
all others ... 1.200 Volt

Standards:

adapted to DIN VDE 0812
DIN EN 60228 class 5 (construction)
DIN 47100 or factory standard (core identification)

Technical data:

Temperature range	in motion		-5°C till +50°C
	fixed		-30°C till +70°C
Flammability	standard		EN 60332-1-2
Bending radius	in motion	x diameter	10
Insulation resistance	min.	[MΩm/km]	100

Number of cores and nominal cross section mm ²	Price EUR / km	Copper figure kg/km	Cond. construction (appr. value) mm	Conductor loop resistance Ohm/km	Overall diameter appr. mm	Weight appr. kg / km
2 x 0,14	711,56	13	18 x 0,10	138,0	3,7	21
3 x 0,14	866,64	15	18 x 0,10	138,0	3,9	25
4 x 0,14	946,78	17	18 x 0,10	138,0	4,1	29
5 x 0,14	1.140,04	20	18 x 0,10	138,0	4,6	35
6 x 0,14	1.266,92	23	18 x 0,10	138,0	4,9	38
7 x 0,14	1.283,07	25	18 x 0,10	138,0	5,0	41
8 x 0,14	1.450,63	26	18 x 0,10	138,0	5,0	45
10 x 0,14	1.864,34	30	18 x 0,10	138,0	5,5	49
12 x 0,14	2.009,67	33	18 x 0,10	138,0	6,3	61
14 x 0,14	2.322,45	36	18 x 0,10	138,0	6,7	67
16 x 0,14	2.582,09	50	18 x 0,10	138,0	7,0	81
18 x 0,14	2.642,80	54	18 x 0,10	138,0	7,3	92
20 x 0,14	2.952,07	61	18 x 0,10	138,0	7,6	104
24 x 0,14	3.328,62	77	18 x 0,10	138,0	8,3	118
25 x 0,14	3.451,72	79	18 x 0,10	138,0	8,5	120

Number of cores and nominal cross section mm²	Price EUR / km	Copper figure kg/km	Cond. construction (appr. value) mm	Conductor loop resistance Ohm/km	Overall diameter appr. mm	Weight appr. kg / km
27 x 0,14	3.685,75	88	18 x 0,10	138,0	8,5	123
36 x 0,14	4.341,98	121	18 x 0,10	138,0	9,3	157
50 x 0,14	5.795,78	161	18 x 0,10	138,0	12,0	320
52 x 0,14	7.352,08	164	18 x 0,10	138,0	11,1	212
1 x 0,25	825,02	12	14 x 0,16	75,5	4,0	14
2 x 0,25	789,00	17	14 x 0,16	75,5	4,3	20
3 x 0,25	884,28	22	14 x 0,16	75,5	4,5	35
4 x 0,25	1.036,99	25	14 x 0,16	75,5	4,8	44
5 x 0,25	1.262,14	30	14 x 0,16	75,5	5,2	50
6 x 0,25	1.466,66	34	14 x 0,16	75,5	5,8	58
7 x 0,25	1.525,77	38	14 x 0,16	75,5	5,8	60
8 x 0,25	2.024,23	44	14 x 0,16	75,5	6,4	67
10 x 0,25	2.169,85	52	14 x 0,16	75,5	7,5	81
12 x 0,25	2.544,42	61	14 x 0,16	75,5	7,7	91
14 x 0,25	3.043,96	67	14 x 0,16	75,5	8,0	116
16 x 0,25	3.235,33	74	14 x 0,16	75,5	8,4	133
18 x 0,25	3.479,53	86	14 x 0,16	75,5	8,8	137
24 x 0,25	4.320,01	119	14 x 0,16	75,5	10,5	185
25 x 0,25	4.544,15	121	14 x 0,16	75,5	10,7	190
27 x 0,25	4.992,31	126	14 x 0,16	75,5	10,9	200
30 x 0,25	5.309,95	138	14 x 0,16	75,5	11,0	214
32 x 0,25	5.521,79	144	14 x 0,16	75,5	11,4	227
36 x 0,25	6.172,43	158	14 x 0,16	75,5	11,8	250
40 x 0,25	6.987,66	170	14 x 0,16	75,5	12,2	289
52 x 0,25	9.012,35	246	14 x 0,16	75,5	13,6	340
2 x 0,34	845,81	22	19 x 0,16	57,7	4,7	33
3 x 0,34	945,87	28	19 x 0,16	57,7	4,9	41
4 x 0,34	1.179,41	34	19 x 0,16	57,7	5,5	48
5 x 0,34	1.406,66	37	19 x 0,16	57,7	6,2	58
7 x 0,34	1.732,38	53	19 x 0,16	57,7	6,7	70
8 x 0,34	2.037,99	56	19 x 0,16	57,7	7,3	93
10 x 0,34	2.264,63	77	19 x 0,16	57,7	8,3	110
12 x 0,34	2.774,46	83	19 x 0,16	57,7	8,5	120
16 x 0,34	3.267,51	98	19 x 0,16	57,7	9,4	147
18 x 0,34	3.712,27	112	19 x 0,16	57,7	10,2	172
24 x 0,34	5.126,41	145	19 x 0,16	57,7	11,7	229
1 x 0,5	997,50	14	16 x 0,21	37,8	3,3	20
2 x 0,5	1.370,58	30	16 x 0,21	37,8	5,2	42
3 x 0,5	1.503,85	41	16 x 0,21	37,8	5,7	55
4 x 0,5	1.703,69	48	16 x 0,21	37,8	6,3	68
5 x 0,5	1.903,33	59	16 x 0,21	37,8	7,0	82
6 x 0,5	2.042,95	71	16 x 0,21	37,8	7,3	104
7 x 0,5	2.437,06	83	16 x 0,21	37,8	7,6	109
8 x 0,5	2.717,13	95	16 x 0,21	37,8	8,1	123
10 x 0,5	3.253,47	104	16 x 0,21	37,8	9,3	135
12 x 0,5	3.560,66	122	16 x 0,21	37,8	9,6	160
16 x 0,5	4.227,26	134	16 x 0,21	37,8	10,9	210
18 x 0,5	4.894,95	158	16 x 0,21	37,8	11,0	210
20 x 0,5	5.038,68	172	16 x 0,21	37,8	12,0	270
24 x 0,5	5.525,47	245	16 x 0,21	37,8	13,2	320
32 x 0,5	7.062,57	313	16 x 0,21	37,8	14,5	360
1 x 0,75	1.219,56	17	24 x 0,21	25,3	3,5	24
2 x 0,75	1.452,51	40	24 x 0,21	25,3	5,8	50
3 x 0,75	1.691,82	52	24 x 0,21	25,3	6,3	71
4 x 0,75	1.900,03	60	24 x 0,21	25,3	7,0	78
5 x 0,75	2.125,00	73	24 x 0,21	25,3	7,6	100
7 x 0,75	2.692,81	104	24 x 0,21	25,3	8,2	131

Number of cores and nominal cross section mm²	Price EUR / km	Copper figure kg/km	Cond. construction (appr. value) mm	Conductor loop resistance Ohm/km	Overall diameter appr. mm	Weight appr. kg / km
8 x 0,75	3.096,78	114	24 x 0,21	25,3	8,7	151
12 x 0,75	4.058,18	160	24 x 0,21	25,3	10,8	218
18 x 0,75	4.210,72	216	24 x 0,21	25,3	12,5	300
1 x 1	1.092,89	19	32 x 0,21	19,5	3,9	29
2 x 1	1.507,13	50	32 x 0,21	19,5	6,3	74
3 x 1	1.817,01	60	32 x 0,21	19,5	6,8	89
4 x 1	2.126,79	74	32 x 0,21	19,5	7,4	107
5 x 1	2.436,77	93	32 x 0,21	19,5	8,0	132
7 x 1	3.087,90	118	32 x 0,21	19,5	8,6	158
12 x 1	4.558,57	175	32 x 0,21	19,5	11,4	254
2 x 1,5	1.852,69	66	29 x 0,25	13,3	7,1	86
3 x 1,5	2.142,64	79	29 x 0,25	13,3	7,5	107
4 x 1,5	2.601,91	112	29 x 0,25	13,3	8,1	129
5 x 1,5	3.043,05	134	29 x 0,25	13,3	8,8	150
7 x 1,5	4.260,27	147	29 x 0,25	13,3	9,5	192
8 x 1,5	4.868,88	164	29 x 0,25	13,3	10,6	219

LiYCY TP

Paired Electronic Control Cable with Tinned Copper Braiding

Application:

To be installed in dry and humid rooms and used as a termination and connection cable in the control, measuring and signal technology.

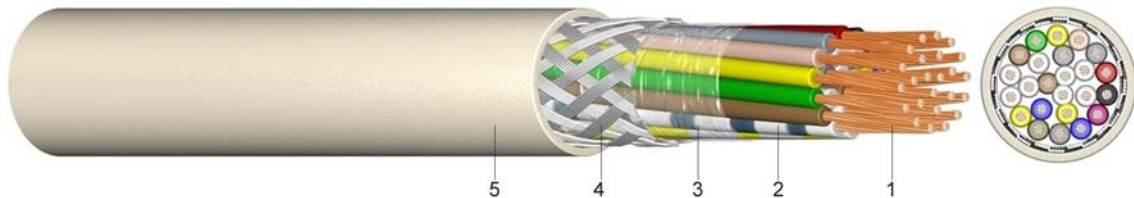

Construction:

- 1 fine-stranded bare copper
- 2 core insulation of polyvinylchloride (PVC)
- 3 layer of plastic foil
- 4 screen of tinned copper wire braiding
- 5 outer sheath of polyvinylchloride (PVC), grey

Information:

Peak operating voltage [V]:

0,14 mm² ... 350 Volt
all others ... 500 Volt

Test Voltage [V_{AC}]:

0,14 mm² ... 800 Volt
all others ... 1.200 Volt

Attenuation at 800 Hz :

0,14mm² app. 2,3 dB/km
0,25mm² app. 1,9 dB/km
0,34mm² app. 1,5 dB/km
0,50mm² app. 1,3 dB/km
0,75mm² app. 1,1 dB/km

Standards:

adapted to DIN VDE 0812
DIN EN 60228 class 5 (construction)
DIN 47100 or factory standard (core identification)

Technical data:

Temperature range	in motion		-5°C till +70°C
	fixed		-30°C till +70°C
Bending radius	in motion	x diameter	10
Flammability	standard		EN 60332-1-2
Insulation resistance	min.	[MΩ/km]	100
Mutal capacitance	max.	[nF/km]	120

Number of pairs and nominal cross section mm ²	Price EUR / km	Copper figure kg/km	Cond. construction (appr. value) mm	Conductor loop resistance Ohm/km	Overall diameter appr. mm	Weight appr. kg / km
2 x 2 x 0,14	1.306,09	24	18 x 0,10	276,0	5,8	34
3 x 2 x 0,14	1.473,74	27	18 x 0,10	276,0	6,2	43
4 x 2 x 0,14	1.798,57	41	18 x 0,10	276,0	6,8	50
5 x 2 x 0,14	2.076,05	46	18 x 0,10	276,0	7,7	70
6 x 2 x 0,14	2.308,58	54	18 x 0,10	276,0	7,9	81
8 x 2 x 0,14	2.610,69	59	18 x 0,10	276,0	8,6	93

Number of pairs and nominal cross section mm²	Price EUR / km	Copper figure kg/km	Cond. construction (appr. value) mm	Conductor loop resistance Ohm/km	Overall diameter appr. mm	Weight appr. kg / km
10 x 2 x 0,14	3.220,07	68	18 x 0,10	276,0	9,5	115
12 x 2 x 0,14	3.642,08	82	18 x 0,10	276,0	9,9	125
16 x 2 x 0,14	4.673,59	97	18 x 0,10	276,0	11,2	148
2 x 2 x 0,25	1.505,04	29	14 x 0,16	151,0	6,6	46
3 x 2 x 0,25	1.846,61	44	14 x 0,16	151,0	7,0	64
4 x 2 x 0,25	2.125,70	57	14 x 0,16	151,0	7,6	73
5 x 2 x 0,25	2.989,54	63	14 x 0,16	151,0	8,4	88
6 x 2 x 0,25	3.182,31	72	14 x 0,16	151,0	8,6	98
8 x 2 x 0,25	3.784,32	80	14 x 0,16	151,0	9,4	118
10 x 2 x 0,25	4.332,71	115	14 x 0,16	151,0	10,7	165
2 x 2 x 0,34	1.778,02	45	19 x 0,16	115,0	7,5	64
3 x 2 x 0,34	2.102,07	54	19 x 0,16	115,0	7,9	86
4 x 2 x 0,34	2.426,00	67	19 x 0,16	115,0	8,5	113
2 x 2 x 0,5	1.809,74	56	16 x 0,21	75,6	8,2	75
3 x 2 x 0,5	2.146,02	77	16 x 0,21	75,6	8,7	98
4 x 2 x 0,5	2.554,19	95	16 x 0,21	75,6	9,3	123
6 x 2 x 0,5	3.499,75	125	16 x 0,21	75,6	10,8	162
8 x 2 x 0,5	5.631,03	150	16 x 0,21	75,6	11,8	190
12 x 2 x 0,5	7.287,47	207	16 x 0,21	75,6	14,0	342
2 x 2 x 0,75	2.719,14	68	24 x 0,21	50,6	8,6	106
3 x 2 x 0,75	3.206,62	88	24 x 0,21	50,6	9,5	140
4 x 2 x 0,75	3.822,49	124	24 x 0,21	50,6	10,8	179
6 x 2 x 0,75	5.052,44	152	24 x 0,21	50,6	12,5	246
8 x 2 x 0,75	6.320,16	188	24 x 0,21	50,6	14,6	300
12 x 2 x 0,75	8.071,20	277	24 x 0,21	50,6	17,8	433
16 x 2 x 0,75	14.630,00	344	24 x 0,21	50,6	18,7	564

JE-Y(ST)Y Bd Cable for Industrial Electronics

Application: Cables for industrial electronics are suitable for fixed installations in dry and humid rooms.

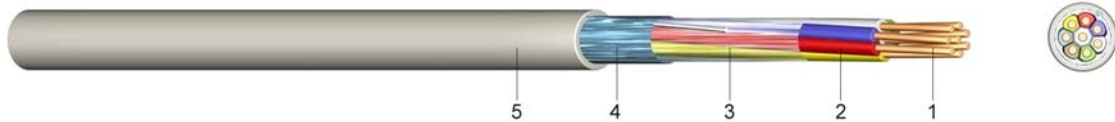

Construction:

- 1 solid bare copper
- 2 core insulation of polyvinylchloride (PVC)
- 3 layer of plastic foil
- 4 static screen of plastic coated aluminium foil with drain wire
- 5 outer sheath of polyvinylchloride (PVC), grey

Standards: DIN VDE 0815 (core identification)
DIN EN 60228 class 1 (construction)

Technical data:

Peak operating voltage		[V]	225 Volt
Test voltage at 50 Hz	core / core	[V] _{AC}	500
	core / screen	[V] _{AC}	2000
Temperature range	in motion		-5°C till +50°C
	fixed		-30°C till +70°C
Bending radius	in motion	x diameter	15
Flammability	standard		EN 60332-1-2
Insulation resistance	min.	[MΩ/km]	100
Mutal capacitance		[Ω/km]	73,2
	max.	[nF/km]	100
Capacitance unbalance 100m	max	[pF]	200

Number of pairs and nominal conductor diameter mm	Price EUR / km	Copper figure kg/km	Insulation thickness mm	Overall diameter appr. mm	Weight appr. kg / km
2 x 2 x 0,8	864,57	25	1,0	5,8	53
4 x 2 x 0,8	1.508,48	45	1,0	7,6	86
8 x 2 x 0,8	2.490,08	85	1,0	10,1	146
12 x 2 x 0,8	3.388,03	126	1,0	10,7	196
16 x 2 x 0,8	4.230,22	166	1,2	12,2	260
20 x 2 x 0,8	5.066,76	206	1,2	13,3	314
24 x 2 x 0,8	6.022,10	246	1,2	14,0	364
32 x 2 x 0,8	8.229,26	327	1,4	18,0	496
40 x 2 x 0,8	9.254,98	407	1,4	19,1	600

JE-LiYCY Bd Cable for Industrial Electronics

Application: Cables for industrial electronics are suitable for fixed installations in dry and humid rooms.

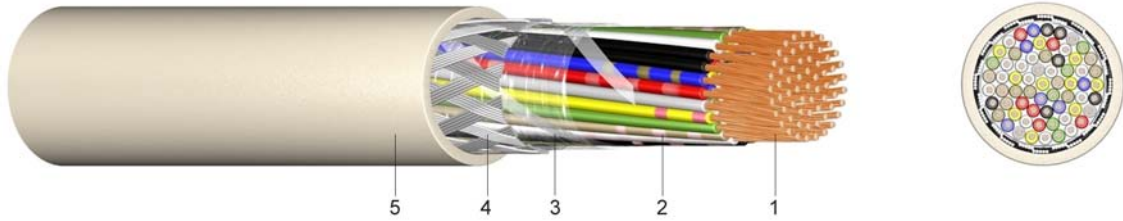

Construction:

- 1 fine-stranded bare copper
- 2 core insulation of polyvinylchloride (PVC)
- 3 layer of plastic foil
- 4 braid of tinned copper wires
- 5 outer sheath of polyvinylchloride (PVC), grey

Standards: DIN VDE 0815 (core identification)
DIN EN 60228 class 5 (construction)

Technical data:

Peak operating voltage		[V]	225
Test voltage at 50 Hz	core / core	[V] _{AC}	500
	core / screen	[V] _{AC}	2000
Temperature range	in motion		-5°C till +50°C
	fixed		-30°C till +70°C
Bending radius	in motion	x diameter	10
Flammability	standard		EN 60332-1-2
Insulation resistance	min.	[MΩ/km]	100
Mutal capacitance		[Ω/km]	78,4
	max.	[nF/km]	100
Capacitance unbalance 100m	max	[pF]	200

Number of pairs and nominal cross section mm ²	Price EUR / km	Copper figure kg/km	Insulation thickness mm	Overall diameter appr. mm	Weight appr. kg / km
2 x 2 x 0,5	2.567,02	51	1,0	7,0	81
4 x 2 x 0,5	3.853,27	87	1,0	9,5	137
8 x 2 x 0,5	6.008,02	144	1,0	13,0	248
12 x 2 x 0,5	7.667,85	196	1,2	15,0	307
16 x 2 x 0,5	9.059,47	249	1,2	16,5	375
20 x 2 x 0,5	10.664,07	299	1,2	18,5	461
24 x 2 x 0,5	12.074,57	348	1,2	20,5	595
32 x 2 x 0,5	14.837,19	444	1,4	23,0	719

YMLCM

Plastic Insulated Low-Frequency Cable with Copper Braiding

Application:

To be installed in dry and humid rooms as termination and connection cable in the low-frequency and studio technology.

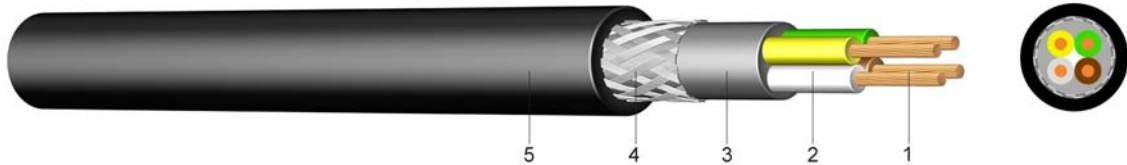

Construction:

- 1 fine-stranded bare copper
- 2 core insulation of polyvinylchloride (PVC)
- 3 inner sheath
- 4 braid of bare copper wires
- 5 outer sheath of polyvinylchloride (PVC), black

Standards:

DIN EN 60228 class 5 (construction)
in according to DIN 47100 or factory standard (core identification)

Technical data:

Nominal voltage U ₀ /U		[V]	350
Test voltage		[V] _{Ac}	800
Temperature range	in motion		+5°C till +50°C
Flammability	standard		EN 60332-1-2
Conductor resistance	max.	[Ohm/km]	26,0
Mutal capacitance	max.	[nF/km]	130

Number of cores and nominal cross section mm ²	Price	Copper figure	Overall diameter	Weight
	EUR / km	kg/km	appr.mm	appr. kg / km
2 x 0,75	1.605,36	30	6,9	70
3 x 0,75	1.821,00	50	7,4	90
4 x 0,75	2.006,70	60	7,9	110

RS-2YCY PiMF

Pair Wise Screened Data Transmission Cable with Overall Bare Copper Braiding

Application:

These transmission cables are to be installed in dry and humid rooms. They are used in data processing and process controlling for high-speed transmission.

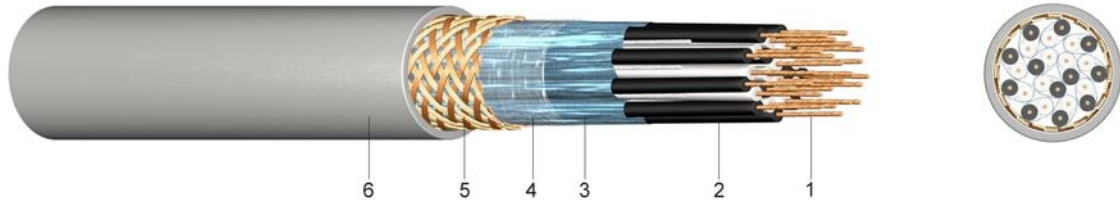

Construction:

- 1 fine-stranded bare copper
- 2 core insulation of polyvinylchloride (PVC)
- 3 each pair is screened with a static screen of plastic coated aluminium foil
- 4 static screen of plastic foil
- 5 braid of bare copper wires
- 6 outer sheath of polyvinylchloride (PVC), grey

Information:

Core identification: black / white (with figure on the white core, 1-1, 2-2,...)

For reinforced PVC outer sheath for underground laying type please send us an enquiry.

Technical data:

	in motion		-5°C till +70°C
Temperature range			
Insulation resistance	R iso	[MΩm/km]	5000
Conductor loop-resistance		[Ωm/km]	39,0
Attenuation	100 MHz	[dB / 100m]	4,5
Impedance	1 KHz	[Ωm]	465,0
	10 KHz	[Ωm]	155,0
	100 KHz	[Ωm]	115,0
Cross-talk attenuation	at 60 Hz	[dB/500m]	78,0

Number of pairs and nominal cross section mm ²	Price	Copper	Overall	Weight
	EUR / km	figure kg/km	diameter appr.mm	appr. kg / km
2 x 2 x 0,5	3.070,68	77	8,0	100
3 x 2 x 0,5	3.767,52	92	8,8	120
4 x 2 x 0,5	4.251,39	112	9,7	145
6 x 2 x 0,5	6.111,01	154	11,9	210
8 x 2 x 0,5	7.523,64	188	13,2	270
12 x 2 x 0,5	11.258,01	294	15,4	375
16 x 2 x 0,5	14.663,33	352	18,2	420

IBM Typ 1A Installation Cable for IBM Cabling Systems IBM Part Nr. 33G2772

Application: Suitable for applications indoors on the wall or in the floor as well as in cable ducts as a data transmission cable for IBM-LAN systems and EC-approved "non plenum type".

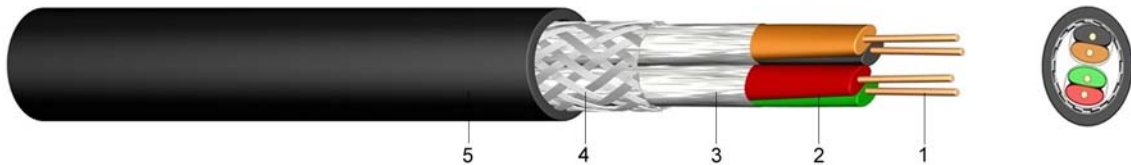

Construction:

- 1 solid bare copper (0,64mm/AWG22)
- 2 core insulation of foam polyethylene (PE)
- 3 pairs are screened with a plastic-laminated aluminium foil
- 4 overall screen of tinned copper braiding
- 5 outer sheath of polyvinylchloride (PVC), black

Standards: EN 50176 - IEC 11801 - TIA/EIA 568A

Technical data:

Nominal voltage U ₀ /U	[V]		125 Volt
Temperature range	in motion		0°C till +50°C
Conductor resistance	max.	[Ohm/km]	110,0
Insulation resistance	min.	[GOhm/km]	5
Mutal capacitance	nom.	[nF] max	29
Capacitance unbalance	max.	[nF] max	1,0
Bending radius	min.	[mm]	75

Number of pairs and nominal conductor diameter mm	Price EUR / km	Copper figure kg/km	Overall diameter appr.mm	Weight appr. kg / km
IBM Typ 1A 2 x 2 x 0,64	1.876,81	38	11,9	102

2Y2YCY

IMB-Twinax Cable

Application:

Suitable for applications indoors as a BUS-installation cable in the data transmission engineering.

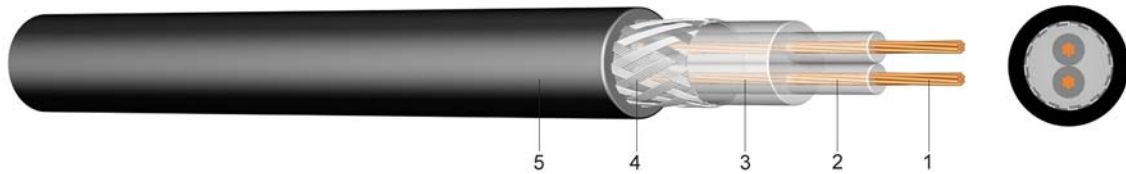

Construction:

- 1 fine-stranded bare copper
- 2 core insulation of polyethylene (PE)
- 3 inner sheath of polyethylene (PE)
- 4 screen of tinned copper braiding
- 5 outer sheath of polyvinylchloride (PVC), black

Standards:

IBM Part. Nr. 7362211

Technical data:

Temperature range	in motion		-10°C till +70°C
Conductor resistance	max.	[Ohm/km]	63,0
Insulation resistance	min.	[MOhm/km]	20
Wave damping	5,0-16,0 MHz	[dB/km]	23,0
Test voltage	Core / Core	[KV] 5min.	5

Number of pairs and nominal cross section AWG Nr.	Price EUR / km	Copper figure kg/km	Overall diameter appr.mm	Weight appr. kg / km
1 x 2 x AWG 20/7	2.098,98	51	8,0	98

J-Y(ST)Y EIB MSR Installation Cable with Static Screen European Installation Bus

Application: The installation in, on and under the wall surface, in dry, humid and wet locations as well as outdoors (if protected) is admissible. As BUS-installation cable (EIB-installation bus) it may be used in HV and LV installations, as control and instrumentation cable (MSR-cable) in HV installations. Suitable for the transmission of measuring data, for the installation in the processing and for the application in the field of the control technology.



Construction:

- 1 solid bare copper
- 2 core insulation of polyvinylchloride (PVC)
- 3 layer of plastic foil
- 4 static screen of plastic coated aluminium foil with drain wire
- 5 outer sheath of polyvinylchloride (PVC)
green or grey

Information: Cores twisted to starquads.
(see technical attachment)

Standards: DIN VDE 0815 (core identification)
DIN EN 60228 class 1 (construction),
EIBA spezifikation

Technical data:

Peak operating voltage		[V]	300
Temperature range	in motion		-5°C till +50°C
	max. on conductor		+70°C
Conductor resistance	max.	[Ohm/km]	73,2
Insulation resistance	min.	[MOhm/km]	100
Mutal capacitance	at 800 Hz	[nF] max.	100
Test voltage	Core / Core	[KV] 5min.	1
	Core and Screen on conductorsurface	[KV] 1min.	4
Bending radius		x diameter	15

Number of pairs and nominal conductor diameter mm	Price EUR / km	Copper figure kg/km	Overall diameter appr. mm	Weight appr. kg / km
2 x 2 x 0,8	864,69	21	6,6	60

J-2Y(ST)Y ST ISDN Cable III Bd

Application: This Integrated Services Digital Network (ISDN) cable is to be used as a termination and connection cable for the transmission of analogue to digital signals up to 16 MHz. It is suitable for ISDN applications in this frequency range such as BTX or fax. Peculiarities of this cable are the cores which are stranded to star quads.



Construction:

- 1 solid bare copper
- 2 core insulation of polyethylene (PE)
- 3 layer of plastic foil
- 4 overall screen of plastic laminated aluminium foil with a tinned drain wire (Ø 0,6mm)
- 5 outer sheath of polyvinylchloride (PVC), grey

Information: Test voltage:
 core/core 800 Volt (50Hz/1min.)
 core/screen .. 2.000 Volt (50Hz/1min.)

Standards: adapted to DIN VDE 0815 and 0816 (core identification)

Technical data:

Peak operating voltage		[V]	300
Temperature range	in motion		-5°C till +50°C
Conductor resistance	max.	[Ohm/km]	130,0
Insulation resistance	min.	[GOhm/km]	5
Attenuation	1-100 MHz	[Ohm]±-15%	100
Mutal capacitance	nom.	[nF] max	52
Attenuation	1,0 MHz	[dB/100m]	35,0
	4,0 MHz	[dB/100m]	55,0
	10,0 MHz	[dB/100m]	73,0
	16,0 MHz	[dB/100m]	86,0
Cross-talk attenuation	1,0 MHz	[dB]	30,0
	10,0MHz	[dB]	30,0

Number of pairs and nominal conductor diameter mm	Price EUR / km	Copper figure kg/km	Overall diameter appr.mm	Calorific potential kWh / m	Tractive force N	Weight appr. kg / km
2 x 2 x 0,6	512,48	15	5,1	0,19	7	36
4 x 2 x 0,6	906,32	26	6,9	0,24	13	59
6 x 2 x 0,6	1.489,51	39	7,3	0,31	18	73
10 x 2 x 0,6	2.012,35	61	8,3	0,37	30	104
20 x 2 x 0,6	3.200,72	121	12,0	0,72	58	188
40 x 2 x 0,6	6.880,66	239	16,2	1,18	115	300
50 x 2 x 0,6	7.832,23	298	15,8	1,48	140	415

PROFIBUS DP Bus Line for Profibus L2 Fast Connect

Application: As an access and connection lines circuit in mechanical engineering, e.g., as a connection circuit between bus segments. By the special construction the circuit is suitable for the application with quick connection technology.

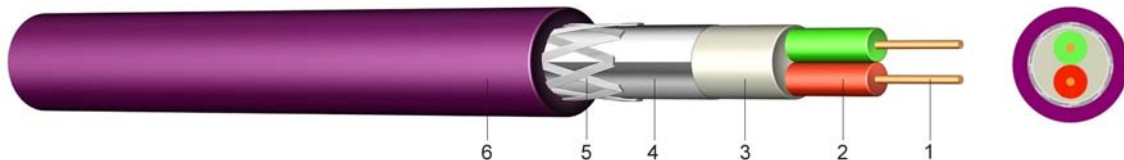

Construction:

- 1 solid bare copper
- 2 core insulation of polyvinylchloride (PVC)
- 3 inner sheath of polyvinylchloride (PVC)
- 4 static screen of plastic coated aluminium foil
- 5 braid of tinned copper wires
- 6 outer sheath of polyvinylchloride (PVC), magenta

Standards: according to DIN 19245 T3
EN 50170

Corresponds to Siemens No. 6XV1830-OEH10

Technical data:

	in motion		-40°C till +70°C
Temperature range	max.	[Ohm/km]	57,1
Conductor resistance	min.	[MOhm/km]	1000
Insulation resistance	1,0-5,0 MHz	[Ohm]	150
Attenuation	min.	[mm]	150
Bending radius			

Number of pairs and nominal conductor diameter mm	Price EUR / km	Copper figure kg/km	Overall diameter appr. mm	Weight appr. kg / km
1 x 2 x 0,64	2.477,49	27	8,0	78

For other types and standards please send us an inquiry.

INTERBUS

Application: The circuit can connect different components within automation devices. The twisted cores are also the basic element. Because all bus components are connected about that, costly parallel wiring can be avoided.

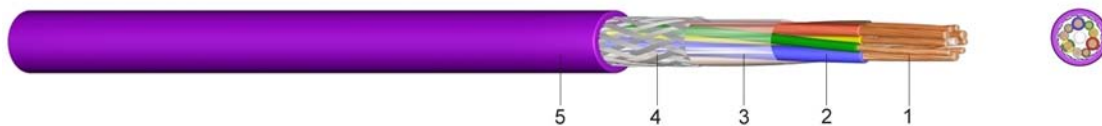

Construction:

- 1 fine-stranded bare copper
- 2 core insulation of polyethylene (PE)
- 3 layer of plastic foil
- 4 braid of tinned copper wires
- 5 outer sheath of polyvinylchloride (PVC), magenta

Information: More types and constructions on enquiry.

Standards: according to DIN 47100 or factory standard (core identification)

Technical data:

Temperature range	in motion		-5°C till +60°C
	not moved		-0°C till +50°C
Conductor resistance	max.	[Ohm/km]	83,0
Attenuation	1-100 MHz	[Ohm]+-15%	100
Mutal capacitance	nom.	[nF] max	50
Attenuation	1,0 MHz	[dB/100m]	2,7
	4,0 MHz	[dB/100m]	5,2
	10,0 MHz	[dB/100m]	8,4
	16,0 MHz	[dB/100m]	11,2

Number of pairs and nominal cross section mm ²	Price EUR / km	Copper figure kg/km	Overall diameter appr.mm	Weight appr. kg / km
3 x 2 x 0,22	2.870,36	39	7,4	70
3 x 2 x 0,25	2.956,47	40	7,9	75

For other types and standards please send us an inquiry.

CAN-BUS

Feld-Bus-Cable CAN

Application:

C(ontroller)A(rea)N(etwork)
serves as a system circuit in the industrial range. Professional bus, CAN bus as well as devices LON can be connected with this system solution.

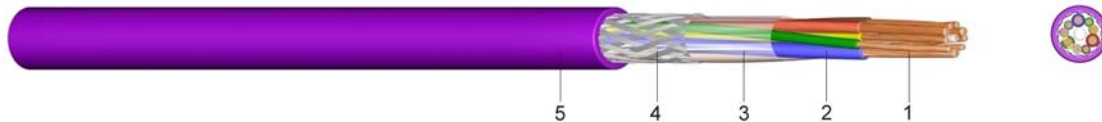

Construction:

- 1 fine-stranded bare copper
- 2 core insulation of foam skin polyethylene (PE)
- 3 layer of plastic foil
- 4 braid of tinned copper wires
- 5 outer sheath of polyvinylchloride (PVC), magenta

Information:

More types and constructions on enquiry.

Standards:

DIN 19245
ISO 11898
EN 50170
DIN 47100 or factory standard (core identification)

Technical data:

Temperature range	in motion		0°C till +50°C
Conductor resistance	max.	[Ohm/km]	39,0
Attenuation	1-100 MHz	[Ohm]±-15%	150
Mutal capacitance	nom.	[nF] max	40

Number of cores and nominal cross section mm ²	Price EUR / km	Copper figure kg/km	Overall diameter appr.mm	Weight appr. kg / km
2 x 2 x 0,5	4.823,97	39,5	7,2	80,0
1 x 2 x 0,75	4.834,60	36,5	8,5	103,0

For other types and standards please send us an inquiry.

LAN 200flex (FTP-Patch)

Patch Cable, Foil-Screened for Local Networks

Application:

In the device connection wiring as a patch, switching, or connecting lead for the use in switching cabinets as well as for the connection of data terminals.
Area of application: IEEE 802.3:10 Base T, 10 Base T Ethernet, 100 Base T, 1000 Base T, FDDI, ISDA, ATM

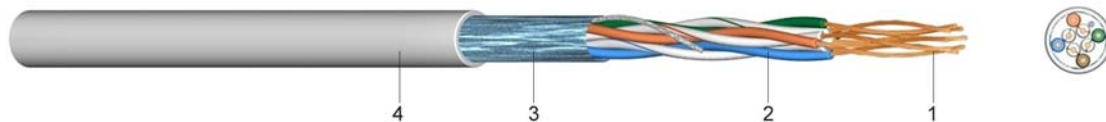

Construction:

- 1 fine-stranded bare copper
- 2 core insulation of polyethylene (PE)
- 3 static screen of plastic-laminated aluminium foil
- 4 outer sheath of polyvinylchloride (PVC), grey

Standards:

Category 5
TIA/EIA 568 B,
ISO/IEC 11801 2. Output
EN 50173-1
IEC 708-1 (core identification)

Technical data:

Temperature range	moved		0°C till +60°C	Bending radius	under tension	8,0 x Ø
Loop impedance		[Ohm/100m]	29,0	Bending radius	no tension	4,0 x Ø
Capacity	max.	[nF/km]	50			
Nom. Velocity of propagation	NVP nom.		77,0			
Attenuation	1-100 MHz	[Ohm]	100,0			
Capacity coupling (f=800 Hz)	K<100	[pF/100m]	150			
Insulation resistance		[GOhm/km]	5			

Number of pairs and nominal dimensions AWG Nr.	Price EUR / km	Copper figure kg/km	Overall diameter appr.mm	Calorific potential kWh / m	Tensile force N	Weight appr. kg / km
4 x 2 x AWG 26 PVC	1.753,01	15	4,9	0,11	30	24
4 x 2 x AWG 26 FRNC	1.851,42	15	4,9	0,11	30	24

LAN 200U (UTP)

Data Transmission Cable for Local Networks, Unscreened, Category 5

Application:

In the horizontal wiring as an installation cable for the transfer in cable canals as well as in pipes within telecommunication installations and data systems.
Area of application: IEEE 802.3:10 Base T, 10 Base T Ethernet, 100 Base T, 1000 Base T, FDDI, ISDA, ATM



Construction:

- 1 solid bare copper
- 2 core insulation of polyvinylchloride (PVC)
- 3 outer sheath of polyvinylchloride (PVC), grey

Standards:

Category 5
TIA/EIA 568 B
ISO/IEC 11801 2. output
EN 50173-1
IEC 708-1 (core identification)

Technical data:

Temperature range	moved		0°C till +60°C	Bending radius	under tension	8,0 x Ø
Loop impedance		[Ohm/100m]	19,0	Bending radius	no tension	4,0 x Ø
Capacity	max.	[nF/km]	50			
Nom. Velocity of propagation	NVP nom.		77,0			
Attenuation	1-100 MHz	[Ohm]	100,0			
Capacity coupling (f=800 Hz)	K<100	[pF/100m]	150			
Insulation resistance		[GOhm/km]	5			

Number of pairs and nominal dimensions AWG Nr.	Price EUR / km	Copper figure kg/km	Overall diameter appr.mm	Calorific potential kWh / m	Tensile force N	Weight appr. kg / km
4 x 2 x AWG 24	1.024,42	17,7	4,9	0,10	80	26

LAN 200 (FTP)

Data Transmission Cable for Local Networks with Overall Shielding, Category 5

Application:

In the horizontal wiring as an installation cable for the transfer in cable canals as well as in pipes within telecommunication installations and data systems.
Area of application: IEEE 802.3:10 Base T, 10 Base T Ethernet, 100 Base T, 1000 Base T, FDDI, ISDA, ATM

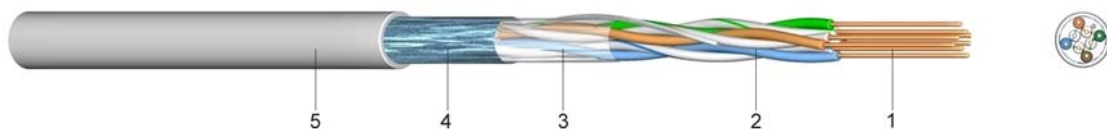

Construction:

- 1 solid bare copper
- 2 core insulation of polyvinylchloride (PVC)
- 3 layer of plastic foil
- 4 overall shielding of aluminium foil with a tinned drain wire \varnothing 0,5mm
- 5 outer sheath of polyvinylchloride (PVC) grey or halogen-free polymer compound, orange, special colours on enquiry

Standards:

Category 5, ETIA-EIA 568 A 5
ISO/IEC 11801, EN 50173, EN 50288-2-1
PVC : IEC 332-1, DIN VDE 0472 part 804 type B
FRNC : IEC 332-1 and 3, IEC 754-2, IEC 1034-2
IEC 708-1 (core identification)

Technical data:

Temperature range	moved		0°C till +60°C	Bending radius	under tension	8,0 x \varnothing
Loop impedance		[Ohm/100m]	19	Bending radius	no tension	4,0 x \varnothing
Capacity	max.	[nF/km]	50			
Nom. Velocity of propagation	NVP nom.		71,0			
Attenuation	1-100 MHz	[Ohm]	100,0 +/- 15			
Coupling resistance	1-100 MHz	[mOhm/m]	10			
Capacity coupling (f=800 Hz)	K<100	[pF/100m]	15			
Insulation resistance		[GOhm/km]	>5			
Test voltage at 50 Hz		[V _{ac}]	1000			

Frequency [MHz]	Line attenuation [dB/100m]		Next [dB] _{NN}		ACR [dB]		ELFEXT [dB] _{ELFEXT}		Return Loss R _L [dB]	
	nom.*	min. CAT 5e	nom.*	min. CAT 5e	nom.*	min. CAT 5e	nom.*	min. CAT 5e	nom.*	min. CAT 5e
1	1,9	2,1	68,3	65,3	66,4	63,2	64,8	64,0	21	20,0
4	3,9	4,1	59,3	56,3	55,4	52,2	52,8	52,0	24	23,0
10	6,3	6,5	53,3	50,3	47,0	43,8	44,8	44,0	26	25,0
16	8,1	8,3	50,3	47,3	42,2	39,0	41,0	40,0	26	25,0
20	9,1	9,3	48,8	45,3	39,2	36,0	39,0	38,0	26	25,0
31,25	11,3	11,7	45,9	42,9	34,6	31,2	35,0	34,0	24,6	23,6
62,5	16,5	17,0	41,4	38,4	24,9	21,3	29,2	28,0	22,5	21,5
100	21,0	22,0	38,3	35,3	17,3	13,3	25,3	24,0	21,2	20,1
125	22,8	24,9	37,3	34,3	14,5	9,4	23,3	22,0	20,4	19,4
200	27,0	-	35,3	-	8,3	-	20,9	-	19,0	-

* Category 5 - Values per ISO / IEC 11801, EN 50173, EN 50288-2-1
* Category 5 - Values per TIA / EIA - 568-A-5

Number of pairs and nominal dimensions AWG Nr.	Price EUR / km	Copper figure kg/km	Overall diameter appr.mm	Calorific potential kWh / m	Tensile force N	Weight appr. kg / km
4 x 2 x AWG 24 PVC	1.255,85	18	6,0	0,12	80	41
4 x 2 x AWG 24 FRNC	1.488,48	18	6,0	0,12	80	41
2 x(4x2x x AWG 24 FVC	2.531,51	36	12,0x6,0	0,24	160	82

LAN 200C (S/FTP)

Data Transmission Cable for Local Networks 2x Overall Shielding, Category 5

Application:

In the horizontal wiring as an installation cable for the transfer in cable canals as well as in pipes within telecommunication installations and data systems.
Area of application: IEEE 802.3:10 Base T, 10 Base T Ethernet, 100 Base T, 1000 Base T, FDDI, ISDA, ATM

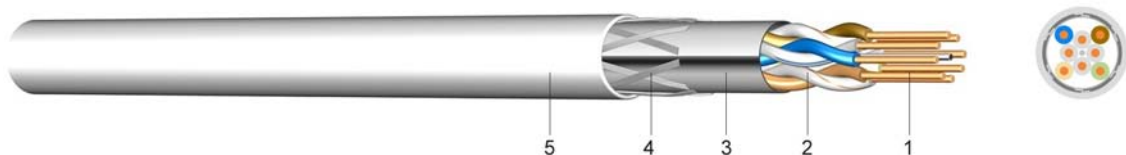

Construction:

- 1 solid bare copper
- 2 core insulation of polyvinylchloride (PVC)
- 3 overall shielding of aluminium foil with a tinned drain \varnothing 0,5mm
- 4 screen of tinned copper braiding
- 5 outer sheath of polyvinylchloride (PVC) grey or halogen-free polymer compound, orange, special colours on enquiry

Standards:

Category 5 EIA-EIA 568 A 5
ISO/IEC 11801, EN 50173, EN 50288-2-1
PVC : IEC 332-1, DIN VDE 0472 part 804 type B
FRNC : IEC 332-1 and 3, IEC 754-2, IEC 1034-2
IEC 708-1 (core identification)

Technical data:

Temperature range	moved		0°C till +60°C	Bending radius	under tension	8,0 x \varnothing
Loop impedance		[Ohm/100m]	19	Bending radius	no tension	4,0 x \varnothing
Capacity	max.	[nF/100m]	50			
Nom. Velocity of propagation	NVP nom.		77,0			
Attenuation	1-100 MHz	[Ohm]	100,0 +/- 15			
Coupling resistance	1-100 MHz	[mOhm/m]	10			
Capacity coupling (f=800 Hz)	K<100	[pF/100m]	15			
Insulation resistance		[GOhm/m]	>5			
Test voltage at 50 Hz		[V _{AC}]	700			

Frequency [MHz]	Line attenuation [dB/100m]		Next [dB] _{NN}		ACR [dB]		ELFEXT [dB] _{ELFEXT}		Return Loss R _L [dB]	
	nom.*	max. CAT 5e	nom.*	min. CAT 5e	nom.*	min. CAT 5e	nom.*	min. CAT 5e	nom.*	min. CAT 5e
1	1,9	2,1	68,3	65,3	66,4	63,2	64,8	64,0	21,0	20,0
4	3,9	4,1	59,3	56,3	55,4	52,2	52,8	52,0	24,0	23,0
10	6,3	6,5	53,3	50,3	47,0	43,8	44,8	44,0	26,0	25,0
16	8,1	8,3	50,3	47,3	42,2	39,0	41,0	40,0	26,0	25,0
20	9,1	9,3	48,8	45,3	39,2	36,0	39,0	38,0	26,0	25,0
31,25	11,3	11,7	45,9	42,9	34,6	31,2	35,0	34,0	24,6	23,6
62,5	16,5	17,0	41,4	38,4	24,9	21,3	29,2	28,0	22,5	21,5
100	21,0	22,0	38,3	35,3	17,3	13,3	25,3	24,0	21,2	20,1
125	22,8	24,9	37,3	34,3	14,5	9,4	23,3	22,0	20,4	19,4
200	27,0	-	35,3	-	8,3	-	20,9	-	19,0	-

* Category 5 - Values per ISO / IEC 11801, EN 50173, EN 50288-2-1
* Category 5 - Values per TIA / EIA - 568-A-5

Number of pairs and nominal dimensions AWG Nr.	Price EUR / km	Copper figure kg/km	Overall diameter appr.mm	Calorific potential kWh / m	Tensile force N	Weight appr. kg / km
4 x 2 x AWG 24 PVC	1.643,53	39	6,5	0,15	120	60
4 x 2 x AWG 24 FRNC	2.143,33	39	6,5	0,15	120	60
2 x(4 x 2 x AWG 24) PVC	3.480,56	78	13,0x6,5	0,30	240	120

LAN 350 (F/UTP)

Data Transmission Cable for Local Networks with central-element and shield, Category 6

Application:

In the horizontal cabling as an installation for laying cable in cable channels and pipes inside of telecommunications equipment and data systems to 350 Mhz. Installation is very easy because of a central element (cross) no individual shield is required.

Usable for: 10Base-T, 100 Base-T, 1000 Base-T, CDDI/TPDDI, ISDN, ATM 155 Mbit/s, TP-PMD 125 Mbit/s, Token Ring 4/16 Mbit/s.

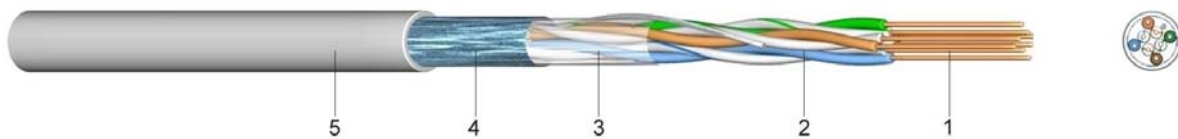

Construction:

- 1 Bare, solid copper conductor, Ø 0,55mm (AWG 24/1)
- 2 core insulation SFS Polyethylen
- 3 layer of plastic foil
- 4 plastic laminated aluminium foil
- 5 PVC-sheath or with halogen free sheath

Standards:

ISO/IEC 11801 2.Edition
EN 50173-1
TIA/EIA 568-B.2
IEC 61156-5
EN 50288-5-1

Technical data:

Temperature range	moved		0°C till +60°C	Bending radius	under tension	8,0 x Ø
Loop impedance		[Ohm/100m]	19	Bending radius	no tension	4,0 x Ø
Capacity	max.	[nF/100m]	50			
Nom. Velocity of propagation	NVP nom.		77,0			
Attenuation	1-100 MHz	[Ohm]	100,0 +/- 22			
Coupling resistance	1-100 MHz	[mOhm/m]	10			
Capacity coupling (f=800 Hz)	K<100	[pF/100m]	150			
Insulation resistance		[GOhm/m]	>5			
Test voltage at 50 Hz		[V _{AC}]	700			

Frequency [MHz]	Line attenuation [dB/100m]		Next [dB] _{NN}		ACR [dB]		Return Loss R _L [dB]	
	nom.*	max. CAT 6	nom.*	min. CAT 6	nom.*	min. CAT 6	nom.*	min. CAT 6
1	1,8	2,1	78	66	76,2	-	22	20,0
4	3,4	3,8	74	65	70,6	-	25	23,1
10	5,4	6,0	70	60	64,6	-	28	25,0
16	6,9	7,6	65	56	58,1	-	28	25,0
20	7,8	8,5	62	55	54,2	-	28	25,0
31,25	9,8	10,8	58	52	48,2	-	27	23,6
62,5	13,8	15,5	55	47	41,2	-	26	21,5
100	17,5	19,9	52	44	34,5	-	25	20,1
155	21,8	25,3	50	41	28,2	-	25	18,8
200	24,9	29,2	48	40	23,1	-	24	18,0
250	27,5	33,0	45	38	17,5	-	24	17,3
300	29,5	-	43	-	13,5	-	22	-
350	33,0	-	41	-	8,0	-	21	-

* Category 6 - Values per ISO / IEC 11801, EN 50173, EN 50288-2-1
* Category 6 - Values per TIA / EIA - 568-A-5

Number of pairs and nominal dimensions AWG Nr.	Price EUR / km	Copper figure kg/km	Overall diameter appr.mm	Calorific potential kWh / m	Tensile force N	Weight appr. kg / km
4 x 2 x AWG 24 PVC	2.373,33	23	7,5	0,23	100	54
4 x 2 x AWG 24 FRNC	4.643,32	23	7,5	0,21	100	54

LAN 600
(S/STP Pimf)

**Data Transmission Cable for Local Networks with
Pair Wise Screening and Overall Shielding
according to a Draft of Category 7**

Application:

This installation cable is suitable for horizontal laying in cable ducts and conduits in telecommunications and data transmission systems.
Useable for: ISDN , B-ISDN, IEEE 802.3 10 Base T Ethernet, IEEE 802.3 100 Base T Ethernet, IEEE 802.5 Token Ring, CDDI (FDDI on Cu), Gigabit-Ethernet , ATM, DQDB, Video.

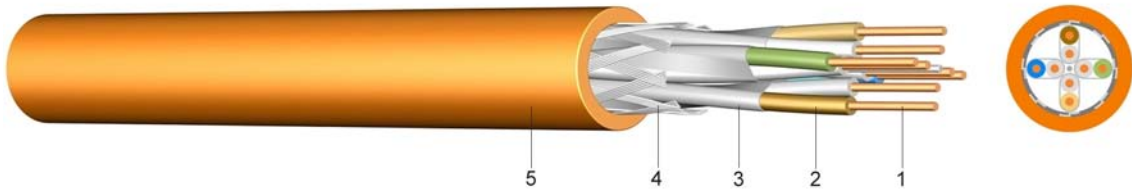

Construction:

- 1 solid bare copper, Ø 0,55mm or 0,64mm
- 2 core insulation of foam-skin polyethylene
- 3 pair wise shielding of plastic-laminated aluminium foil with a tinned drain wire Ø 0,4
- 4 braid of tinned copper wires
- 5 outer sheath of polyvinylchloride (PVC) grey or halogen-free polymer compound, orange

Standards:

- EN 50288-4-1
- IEC 332-1 , IEC 54-2, IEC 1034-2
- IEC 708-1 (core identification)

Technical data:

Temperature range	moved		0°C till +60°C	Bending radius	under tension	8,0 x Ø
Loop impedance		[Ohm/100m]	14,5	Bending radius	no tension	4,0 x Ø
Capacity	max.	[nF/100m]	50			
Nom. Velocity of propagation	NVP nom.		77,0			
Attenuation	1-100 MHz	[Ohm]	100,0 +/- 25			
Coupling resistance	1-100 MHz	[mOhm/m]	< 10			
Capacity coupling (f=800 Hz)	K<100	[pF/100m]	1500			
Insulation resistance		[GOhm/m]	>5			
Test voltage at 50 Hz		[V _{AC}]	700			

Frequency [MHz]	Line attenuation [dB/100m]		Next [dB] _{NN}		ACR [dB]		ELFEXT [dB] ELFEXT		Return Loss R _L [dB]	
	nom.*	max. CAT 7	nom.*	min. CAT 7	nom.*	min. CAT 7	nom.*	min. CAT 7	nom.*	min. CAT 7
1	1,9	2,0	85	80	83,1	78,1	80	78	24	-
4	3,4	3,6	85	80	81,6	76,4	80	78	24	23,1
10	5,5	5,7	85	80	79,5	74,3	76	74	26	25,0
16	7,0	7,2	85	80	78,0	72,8	72	70	26	25,0
20	7,8	8,1	85	80	77,2	71,9	70	68	26	25,0
100	18,2	18,5	77	72,4	58,8	53,9	56	54	21	20,1
155	22,8	23,4	75	69,6	52,2	46,2	53	51	20	18,8
200	26,0	26,8	74	67,9	48,0	41,4	50	48	19	17,3
300	32,0	33,3	70	65,3	38,0	32,0	46	44	19	17,3
600	47,0	48,9	65	60,8	18,0	11,9	40	38	19	17,3

* Category 7 - Values per ISO / IEC 11801, EN 50173

Number of pairs and nominal dimensions AWG Nr.	Price EUR / km	Copper figure kg/km	Overall diameter appr.mm	Calorific potential kWh / m	Tensile force N	Weight appr. kg / km
4 x 2 x AWG 23 PVC	3.394,42	44	7,5	0,17	110	68
4 x 2 x AWG 23 FRNC	2.951,63	44	7,5	0,17	110	68
2 x(4 x 2 x AWG 23) PVC	6.788,84	88	15,0x7,5	0,34	220	136
2 x(4 x 2 x AWG 23) FRNC	5.903,25	88	15,0x7,5	0,34	220	136

LAN 900
(S/STP Pimf)

**Data Transmission Cable for Local Networks with
Pair Wise Screening and Overall Shielding
Category 7**

Application:

In the horizontal wiring as an installation cable for the transfer in cable canals as well as in pipes within telecommunication installations and data systems.
Area of application: ISDA, B-ISDA, IEEE 802.3 10 Base T Ethernet, IEEE 802.3 100 Base T Ethernet, IEEE 802.5 Token Ring CCDI (FDDI at Cu), Gigabit-Ethernet, ATM, DQDB, Video

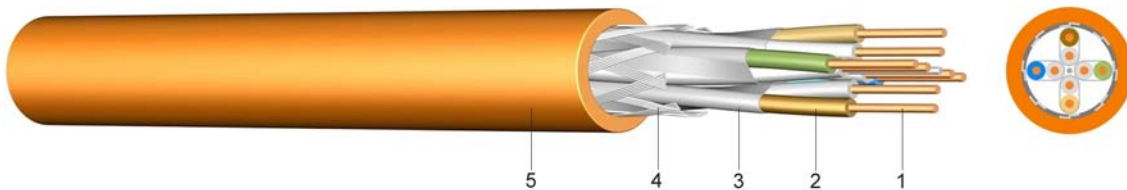

Construction:

- 1 solid bare copper, Ø 0,57mm
- 2 core insulation of foam-skin polyethylene
- 3 pair wise screen of plastic laminated aluminium foil with a tinned drain wire Ø 0,4
- 4 braid of tinned copper wires
- 5 outer sheath of polyvinylchloride (PVC) yellow or halogen-free polymer compound orange

Standards:

EN 50288-4-1
IEC 332-1, IEC 754-2 , IEC 1034-2
IEC 708-1 (core identification)

Technical data:

Temperature range	moved		0°C till +60°C	Bending radius	under tension	8,0 x Ø
Loop impedance		[Ohm/100m]	14,5	Bending radius	no tension	4,0 x Ø
Capacity	max.	[nF/100m]	50			
Nom. Velocity of propagation	NVP nom.		77,0			
Attenuation	1-100 MHz	[Ohm]	100,0 +/- 25			
Coupling resistance	1-100 MHz	[mOhm/m]	10			
Capacity coupling (f=800 Hz)	K<100	[pF/100m]	150			
Insulation resistance		[GOhm/m]	>5			
Test voltage at 50 Hz		[V _{ac}]	700			

Frequency [MHz]	Line attenuation [dB/100m]		Next [dB] _{NN}		ACR [dB]		ELFEXT [dB] ELFEXT		Return Loss R _L [dB]	
	nom.*	max. CAT 7	nom.*	min. CAT 7	nom.*	min. CAT 7	nom.*	min. CAT 7	nom.*	min. CAT 7
1	1,9	2,0	90	80,0	88,1	78,1	85	78	24,0	-
4	3,4	3,6	90	80,0	86,6	76,4	85	78	24,0	23,1
10	5,5	5,7	90	80,0	84,5	74,3	80	74	26,0	25,0
20	7,8	8,1	90	80,0	82,2	71,9	75	68	26,0	25,0
31,25	9,6	10,1	90	80,0	80,4	69,9	72	64	25,0	23,6
62,5	14,0	14,5	80	75,1	61,1	60,6	66	58	22,5	21,5
100	18,2	18,5	78	72,4	59,8	53,9	60	54	21,0	20,1
155	22,8	23,4	77	69,9	54,2	46,2	58	51	20,0	18,8
200	26,0	26,8	75	69,9	49,0	41,4	55	48	19,0	17,3
300	32,0	33,3	72	65,3	40,0	32,0	50	44	19,0	17,3
600	47,0	48,9	67	60,8	20,0	11,9	45	38	19,0	17,3
900	56,0	-	61	-	5,0	-	35	-	17,3	-

* Category 7 - Values per ISO / IEC 11801, EN 50173

Number of pairs and nominal dimensions AWG Nr.	Price EUR / km	Copper figure kg/km	Overall diameter appr.mm	Calorific potential kWh / m	Tensile force N	Weight appr. kg / km
4 x 2 x AWG 23 PVC	3.547,66	44	8,0	0,17	190	74
4 x 2 x AWG 23 FRNC	3.547,66	44	8,0	0,16	190	74
2 x(4 x 2 x AWG 23) PVC	7.095,31	88	16,0x8,0	0,35	380	148
2 x(4 x 2 x AWG 23) FRNC	6.213,95	88	16,0x8,0	0,32	380	148

LAN 1200 (S/STP Pimf)

Data Transmission Cable with Pair Wise Shielding and Overall Shielding, Category 7

Application:

In the horizontal wiring as an installation cable for the transfer in cable canals as well as in pipes within telecommunication installations and data systems.
Area of application: ISDA, B-ISDA, IEEE 802.3 10 Base T Ethernet, IEEE 802.3 100 Base T Ethernet, IEEE 802.5 Token Ring CCDI (FDDI at Cu), Gigabit-Ethernet, ATM, DQDB, Video

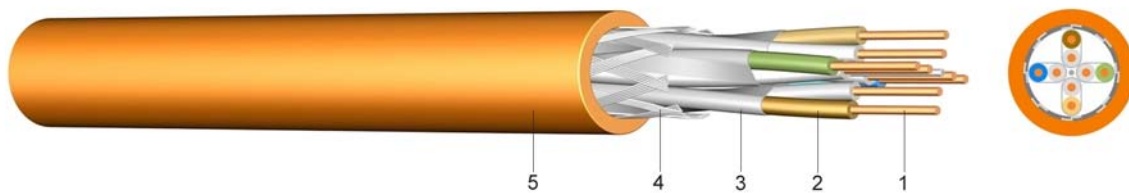

Construction:

- 1 solid bare copper, \varnothing 0,55mm or 0,64mm
- 2 core insulation of foam-skin polyethylene
- 3 pair wise shielding of plastic laminated aluminium with a tinned drain wire (\varnothing 0,4)
- 4 braid of tinned copper wires
- 5 outer sheath of halogen-free polymer compound, yellow or orange

Standards:

Category 7
EN 50288-4-1
IEC 332-1, IEC 754-2, IEC 1034-2
IEC 708-1 (core identification)

Technical data:

Temperature range	moved		-20°C till +60°C	Bending radius	under tension	8,0 x \varnothing
Loop impedance		[Ohm/100m]	11,5	Bending radius	no tension	4,0 x \varnothing
Capacity	max.	[nF/100m]	50			
Nom. Velocity of propagation	NVP nom.		77,0			
Attenuation	1-100 MHz	[Ohm]	100,0 +/- 25			
Coupling resistance	1-100 MHz	[mOhm/m]	10			
Capacity coupling (f=800 Hz)	K<100	[pF/100m]	150			
Insulation resistance		[GOhm/m]	>5			
Test voltage at 50 Hz		[V _{AC}]	700			

Frequency [MHz]	Line attenuation [dB/100m]		Next [dB] _{NN}		ACR [dB]		ELFEXT [dB] ELFEXT		Return Loss R _L [dB]	
	nom.*	max. CAT 7	nom.*	min. CAT 7	nom.*	min. CAT 7	nom.*	min. CAT 7	nom.*	min. CAT 7
1	2,0	-	90	78	88,0	-	85	-	23,0	-
4	3,2	3,5	90	78	86,8	-	85	75	24,0	23,0
10	5,1	5,4	90	78	84,9	-	80	71	26,0	25,0
20	6,5	6,8	90	78	83,5	-	75	65	26,0	25,0
62,5	13,4	13,7	90	78	76,6	-	65	55	23,5	22,5
100	17,0	17,5	83	76	66,0	-	61	51	22,5	21,5
200	24,5	25,3	78	71	53,5	-	55	45	21,0	20,0
300	31,1	31,5	77	69	45,9	-	51	41	20,1	19,1
600	45,0	46,3	75	64	30,0	-	45	35	18,6	17,6
900	56,9	58,3	73	62	16,1	-	42	32	17,7	16,7
1000	60,5	62,0	72	61	11,5	-	41	31	17,3	16,5
1200	67,0	69,0	70	60	3,0	-	39	29	17,3	16,1

* Category 7 - Values per ISO / IEC 11801, EN 50173

Number of pairs and nominal dimensions AWG Nr.	Price EUR / km	Copper figure kg/km	Overall diameter appr.mm	Calorific potential kWh / m	Tensile force N	Weight appr. kg / km
4 x 2 x AWG22 FRNC	3.749,86	52	8,5	0,19	150	78
2 x(4 x 2 x AWG22)FRNC	7.499,71	104	17,0x8,5	0,38	300	156

A-DQ(ZN)2Y Light Dielectric Outdoor Cable with or without A-DQ(ZN)B2Y Non-Metallic Rodent Protection

Application:

This metal-free optical fibre outdoor cable is suitable for installations directly into the earth or in conduits in telecommunications and data processing systems. The stranded design (n x m) is available till 60 fibres, and with a multifunctional used reinforced glass roving braiding as a non-metallic stress relieving element and an armour for rodent protection.

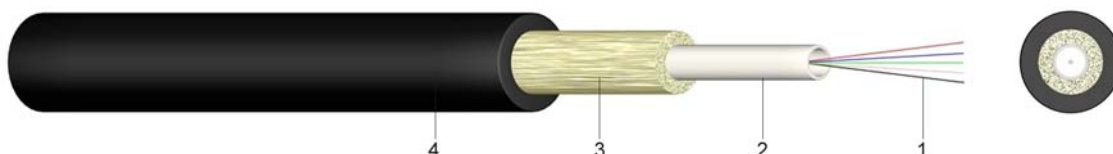

Construction:

- 1 fibre glass with 50 or 62,5 µm
- 2 filled with waterproof gel
- 3 protection form rodent with glass roving
- 4 outer sheath of polyethylene (PE), black

Standards:

adapted to DIN VDE 0888

Technical data:

Temperature range

transport / storage
operational

-30°C till +70°C
-20°C till +60°C

Bending radius

under tension

x diameter

20

Bending radius

no tension

x diameter

15

Description	Price EUR / km	Overall diameter appr. mm	Weight appr. kg / km	Crush strenght permanent N/dm	Tractive force installation / operation N
A-DQ(ZN)2Y					
4 G 50/125	4.330,35	11,0	90	3.000	3.000 / 2.000
8 G 50/125	6.654,42	11,0	90	3.000	3.000 / 2.000
12 G 50/125	8.938,83	11,0	90	3.000	3.000 / 2.000
16 G 50/125	13.507,64	11,0	90	3.000	3.000 / 2.000
24 G 50/125	18.970,30	11,0	90	3.000	3.000 / 2.000
4 G 62,5/125	5.154,73	11,0	90	3.000	3.000 / 2.000
8 G 62,5/125	8.144,28	11,0	90	3.000	3.000 / 2.000
12 G 62,5/125	11.521,23	11,0	90	3.000	3.000 / 2.000
24 G 62,5/125	24.830,20	11,0	90	3.000	3.000 / 2.000
A-DQ(ZN)B2Y					
4 G 50/125	4.767,36	11,5	105	4.000	5.000 / 3.000
8 G 50/125	7.151,10	11,5	105	4.000	5.000 / 3.000
12 G 50/125	9.336,16	11,5	105	4.000	5.000 / 3.000
16 G 50/125	14.500,84	11,5	105	4.000	5.000 / 3.000
24 G 50/125	19.804,51	11,5	105	4.000	5.000 / 3.000
4 G 62,5/125	5.561,89	11,5	105	4.000	5.000 / 3.000
8 G 62,5/125	8.740,17	11,5	105	4.000	5.000 / 3.000
12 G 62,5/125	11.918,44	11,5	105	4.000	5.000 / 3.000
24 G 62,5/125	25.823,40	11,5	105	4.000	5.000 / 3.000

Further types in singlemode or multimode style upon request

90 E/N/P/C

PVC Insulated Compensating and Extension Cable

Application:

These cables are suitable for installations in dry, humid and wet locations as temperature measuring cables for areas such as the plastic industry in machine engineering, industrial oven construction as well as blast furnace plants in the steel industry. PVC-, fibre-glass- and asbestos-substitute insulated or sheathed compensating and extension cables are not suitable for open-air use except for the PVC-sheathed solid conductor type which can be used for underground laying, too.

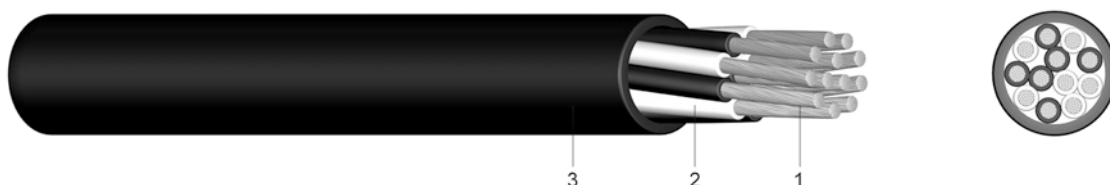

Construction:

- 1 solid or fine-stranded conductor
- 2 core insulation of polyvinylchloride (PVC)
- 3 outer sheath of polyvinylchloride (PVC)

Standards:

IEC 60584 (core identification)

Technical data:

Temperature range

in motion
fixed

-5°C till +70°C
-25°C till +70°C

Flammability

standard

EN 60332-1-2

Type	Price	Materials	for	Conductor	Form	Overall	Weight
Number of cores cross section mm ²	EUR / km	per DIN 43713	thermo- couple	construct. appr.value mm		diameter appr. mm	appr. kg / km
90E 9L 2 x 1,5	5.375,91	Fe-CuNi	Typ L	48 x 0,20	round	7,0	79
90N 9L 2 x 1,5	5.375,91	SoNiCr-SoNi	Typ K	48 x 0,20	round	7,0	79
90P 9L 2 x 1,5	5.375,91	SoPtRh-SoPt	Typ S	48 x 0,20	round	7,0	79
90C 9L 2 x 1,5	5.375,91	Cu-CuNi	Typ U	48 x 0,20	round	7,0	79
90E 9L 2 x 0,22	2.822,36	Fe-CuNi	Typ L	7 x 0,20	round	4,0	22
90N 9L 2 x 0,22	2.822,36	SoNiCr-SoNi	Typ K	7 x 0,20	round	4,0	22
90P 9L 2 x 0,22	2.822,36	SoPtRh-SoPt	Typ S	7 x 0,20	round	4,0	22
90C 9L 2 x 0,22	2.822,36	Cu-CuNi	Typ U	7 x 0,20	round	4,0	22
90E 12L 2 x 1,5	4.032,02	Fe-CuNi	Typ L	48 x 0,20	oval	4,3 x 7,0	69
90N 12L 2 x 1,5	4.032,02	SoNiCr-SoNi	Typ K	48 x 0,20	oval	4,3 x 7,0	69
90P 12L 2 x 1,5	4.032,02	SoPtRh-SoPt	Typ S	48 x 0,20	oval	4,3 x 7,0	69
90C 12L 2 x 1,5	4.032,02	Cu-CuNi	Typ U	48 x 0,20	oval	4,3 x 7,0	69
90E 12D 2 x 1,5	3.225,50	Fe-CuNi	Typ L	1 x 1,38	oval	4,2 x 6,8	61
90N 12D 2 x 1,5	3.225,50	SoNiCr-SoNi	Typ K	1 x 1,38	oval	4,2 x 6,8	61
90P 12D 2 x 1,5	3.225,50	SoPtRh-SoPt	Typ S	1 x 1,38	oval	4,2 x 6,8	61
90C 12D 2 x 1,5	3.225,50	Cu-CuNi	Typ U	1 x 1,38	oval	4,2 x 6,8	61

Type	Price	Materials	for	Conductor	Form	Overall	Weight
Number of cores cross section mm ²	EUR / km	per DIN 43713	thermo- couple	construct. appr.value mm		diameter appr. mm	appr. kg / km
90. 9-4L 4 x 1,5	8.063,92	E / N / P / C		48 x 0,20	round	8,1	119
90. 9-6L 6 x 1,5	10.751,93	E / N / P / C		48 x 0,20	round	10,1	184
90. 9-12L 12 x 1,5	22.847,97	E / N / P / C		48 x 0,20	round	13,2	312
90. 9-16L 16 x 1,5	29.567,99	E / N / P / C		48 x 0,20	round	15,1	419
90. 9-20L 20 x 1,5	33.600,17	E / N / P / C		48 x 0,20	round	16,7	520
90. 9-24L 24 x 1,5	43.008,06	E / N / P / C		48 x 0,20	round	19,0	614
90. 9-32L 32 x 1,5	57.792,12	E / N / P / C		48 x 0,20	round	20,9	793
90. 9-36L 36 x 1,5	63.168,14	E / N / P / C		48 x 0,20	round	22,1	904
90. 9-40L 40 x 1,5	71.232,17	E / N / P / C		48 x 0,20	round	24,1	1.032

Further cross-sections and core-quantities as well as standards and configurations upon request

90 E/N/P/C

PVC Insulated Compensating and Extension Cable with Screening

Application:

These cables are suitable for installations in dry, humid and wet locations as temperature measuring cables for areas such as the plastic industry in machine engineering, industrial oven construction as well as blast furnace plants in the steel industry. PVC-, fibre-glass- and asbestos-substitute insulated or sheathed compensating and extension cables are not suitable for open-air use except for the PVC-sheathed solid conductor type which can be used for underground laying, too.

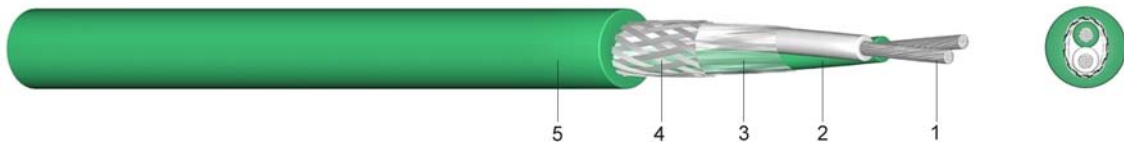

Construction:

- 1 solid or fine-stranded conductor, conductor material according to the element-type
- 2 core insulation of polyvinylchloride (PVC)
- 3 layer of plastic foil
- 4 screening of tinned copper braiding
- 5 outer sheath of polyvinylchloride (PVC)

Standards:

IEC 60584 (core identification)

Technical data:

Temperature range

in motion
fixed

-5°C till +70°C

-25°C till +70°C

Flammability

standard

EN 60332-1-2

Type	Price	Materials per DIN 43713	for thermo-couple	Conductor construct. appr. value mm	Form	Overall diameter appr. mm	Weight appr. kg / km
Number of cores cross section mm ²	EUR / km						
with Copper braid							
90E 5L 2 x 1,5	6.585,57	Fe-CuNi	Typ L	48 x 0,20	round	8,1	93
90N 5L 2 x 1,5	6.585,57	SoNiCr-SoNi	Typ K	48 x 0,20	round	8,1	93
90P 5L 2 x 1,5	6.585,57	SoPtRh-SoPt	Typ S	48 x 0,20	round	8,1	93
90C 5L 2 x 1,5	6.585,57	Cu-CuNi	Typ U	48 x 0,20	round	8,1	93
with Aluminium foil							
90E 20L 2 x 1,5	5.375,91	Fe-CuNi	Typ L	48 x 0,20	round	8,0	75
90N 20L 2 x 1,5	5.375,91	SoNiCr-SoNi	Typ K	48 x 0,20	round	8,0	75
90P 20L 2 x 1,5	5.375,91	SoPtRh-SoPt	Typ S	48 x 0,20	round	8,0	75
90C 20L 2 x 1,5	5.375,91	Cu-CuNi	Typ U	48 x 0,20	round	8,0	75

Type Number of cores cross section mm ²	Price EUR / km	Materials per DIN 43713	for thermo- couple	Conductor construct. appr.value mm	Form	Overall diameter appr. mm	Weight appr. kg / km
with Aluminium foil							
90E 20D 2 x 1,5	4.703,84	Fe-CuNi	Typ L	1 x 1,38	round	8,2	82
90N 20D 2 x 1,5	4.703,84	SoNiCr-SoNi	Typ K	1 x 1,38	round	8,2	82
90P 20D 2 x 1,5	4.703,84	SoPtRh-SoPt	Typ S	1 x 1,38	round	8,2	82
90C 20D 2 x 1,5	4.703,84	Cu-CuNi	Typ U	1 x 1,38	round	8,2	82
90. 20-4D 4 x 1,5	8.063,92	E / N / P / C		1 x 1,38	round	10,8	137
90. 20-6D 6 x 1,5	12.096,29	E / N / P / C		1 x 1,38	round	12,4	186
90. 20-12D 12 x 1,5	21.503,98	E / N / P / C		1 x 1,38	round	16,3	362
90. 20-16D 16 x 1,5	26.879,87	E / N / P / C		1 x 1,38	round	16,8	423
90. 20-20D 20 x 1,5	34.944,03	E / N / P / C		1 x 1,38	round	20,3	542
90. 20-24D 24 x 1,5	40.320,05	E / N / P / C		1 x 1,38	round	22,5	638
90. 20-28D 28 x 1,5	47.040,08	E / N / P / C		1 x 1,38	round	24,2	749
90. 20-30D 30 x 1,5	49.728,08	E / N / P / C		1 x 1,38	round	24,2	788
90. 20-32D 32 x 1,5	53.760,10	E / N / P / C		1 x 1,38	round	25,1	847

Further cross-sections and core-quantities as well as standards and configurations upon request

90 E/N/P/C

Silicone Insulated Compensating and Extension Cable with or without Steel Wire Braiding

Application:

These cables are suitable for installations in dry, humid and wet locations as temperature measuring cables for areas such as the plastic industry in machine engineering, industrial oven construction as well as blast furnace plants in the steel industry. PVC-, fibre-glass- and asbestos-substitute insulated or sheathed compensating and extension cables are not suitable for open-air use except for the PVC-sheathed solid conductor type which can be used for underground laying, too.



Construction:

- 1 fine-stranded conductor, conductor material acc. to the element-type
- 2 core insulation of silicone (2G11)
- 3 outer sheath of silicone (2GM1)
- 4 steel wire braiding

Standards:

IEC 60584 (core identification)

Technical data:

Temperature range

in motion
fixed
temporary resilient
standard

-25°C till +180°C
-25°C till +180°C
+250°C
EN 60332-1-2

Flammability

Type Number of cores cross section mm ²	Price EUR / km	Materials per DIN 43713	for thermo- couple	Conductor construct. appr. value mm	Form	Overall. dieameter appr. mm	Weight appr. kg / km
without steel braid							
90E 15L 2 x 1,5	9.945,52	Fe-CuNi	Typ L	48 x 0,20	round	7,7	76
90N 15L 2 x 1,5	9.945,52	SoNiCr-SoNi	Typ K	48 x 0,20	round	7,7	76
90P 15L 2 x 1,5	9.945,52	SoPtRh-SoPt	Typ S	48 x 0,20	round	7,7	76
90C 15L 2 x 1,5	9.945,52	Cu-CuNi	Typ U	48 x 0,20	round	7,7	76
with steel braid							
90E 3Ln 2 x 1,5	7.123,17	Fe-CuNi	Typ L	48 x 0,20	oval	5,2 x 7,4	62
90N 3Ln 2 x 1,5	7.123,17	SoNiCr-SoNi	Typ K	48 x 0,20	oval	5,2 x 7,4	62
90P 3Ln 2 x 1,5	7.123,17	SoPtRh-SoPt	Typ S	48 x 0,20	oval	5,2 x 7,4	62
90C 3Ln 2 x 1,5	7.123,17	Cu-CuNi	Typ U	48 x 0,20	oval	5,2 x 7,4	62
with steel braid							
90E 15LP 2 x 1,5	11.423,87	Fe-CuNi	Typ L	48 x 0,20	oval	7,8	105
90N 15LP 2 x 1,5	11.423,87	SoNiCr-SoNi	Typ K	48 x 0,20	oval	7,8	105
90P 15LP 2 x 1,5	11.423,87	SoPtRh-SoPt	Typ S	48 x 0,20	oval	7,8	105
90C 15LP 2 x 1,5	11.423,87	Cu-CuNi	Typ U	48 x 0,20	oval	7,8	105
with steel braid							
90E 15LP 2 x 1,5	11.423,87	Fe-CuNi	Typ L	48 x 0,20	oval	6,0 x 8,2	85
90N 15LP 2 x 1,5	11.423,87	SoNiCr-SoNi	Typ K	48 x 0,20	oval	6,0 x 8,2	85
90P 15LP 2 x 1,5	11.423,87	SoPtRh-SoPt	Typ S	48 x 0,20	oval	6,0 x 8,2	85
90C 15LP 2 x 1,5	11.423,87	Cu-CuNi	Typ U	48 x 0,20	oval	6,0 x 8,2	85

Further cross-sections and core-quantities as well as standards and configurations upon request

90 E/N/P/C

Silicone Insulated Compensating and Extension Cable with Screening

Application:

These cables are suitable for installations in dry, humid and wet locations as temperature measuring cables for areas such as the plastic industry in machine engineering, industrial oven construction as well as blast furnace plants in the steel industry. PVC-, fibre-glass- and asbestos-substitute insulated or sheathed compensating and extension cables are not suitable for open-air use except for the PVC-sheathed solid conductor type which can be used for underground laying, too.

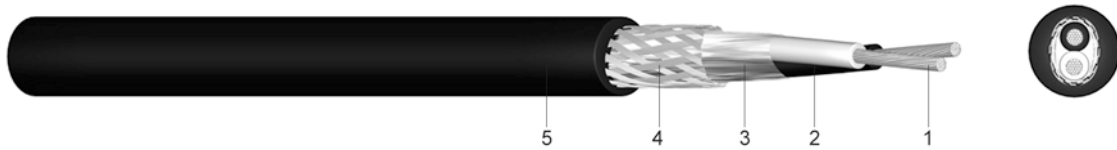

Construction:

- 1 solid or fine-stranded conductor
conductor material according to the element-type
- 2 core insulation of silicone (2G11)
- 3 layer of plastic foil
- 4 screening of an aluminium foil with drain wire
- 5 outer sheath of silicone (2GM1)

Standards:

IEC 60584 (core identification)

Technical data:

Temperature range

in motion
fixed
temporary resilient
standard

-25°C till +180°C
-25°C till +180°C
+250°C
EN 60332-1-2

Flammability

Type Number of cores cross section mm ²	Price EUR / km	Materials per DIN 43713	for thermo- couple	Conductor construct. appr. value mm	Form	Overall diameter appr. mm	Weight approx. kg / km
90E 6L 2 x 1,5	9.407,92	Fe-CuNi	Typ L	48 x 0,20	round	8,0	94
90E 6L 2 x 1,5	9.407,92	SoNiCr-SoNi	Typ K	48 x 0,20	round	8,0	94
90E 6L 2 x 1,5	9.407,92	SoPtRh-SoPt	Typ S	48 x 0,20	round	8,0	94
90E 6L 2 x 1,5	9.407,92	Cu-CuNi	Typ U	48 x 0,20	round	8,0	94
90E 6L 2 x 1,5	9.004,77	Fe-CuNi	Typ L	1 x 1,38	round	7,8	92
90E 6L 2 x 1,5	9.004,77	SoNiCr-SoNi	Typ K	1 x 1,38	round	7,8	92
90E 6L 2 x 1,5	9.004,77	SoPtRh-SoPt	Typ S	1 x 1,38	round	7,8	92
90E 6L 2 x 1,5	9.004,77	Cu-CuNi	Typ U	1 x 1,38	round	7,8	92

Further cross-sections and core-quantities as well as standards and configurations upon request

Table of Contents - General Information

Drum overview	Page
Drum conditions	244
Dimensions, weights, prices	245
Capacity of cable drums	246
Drum assignment with reference to the cable or wire diameter and the smallest admissible drum core diameter	247

Conductor construction for insulated cables and wires

Conductor construction	248
Construction and conductor resistance	249
Conversion table for standard cross sections	250
Capacitance according National Electric Code (NEC)	251
Insulation and sheath materials	252
Mechanical, thermal, electrical and chemical properties of insulation and sheath materials	253

Abbreviation key for

Wires according to harmonized requirements	254
Power Cables	255
Telecommunication cables	256

Core identification for

Cables and wires	257
Core colour-coding of PVC control lines with 6 or more coloured cores	258
Electronic cables	259
Telecommunication cables according to VDE	260
Telecommunication cables according to ÖVE	261
Data transmission cables category 5	262

Laying references

Guidelines for the laying of cables in cable chains	263
Hints about transport, storage, and laying of data transmission cables Cat.5, Cat.6 and Cat.7	263
Permissible bending radii and Temperatures for laying at harmonized Wires	264
Permissible bending radii and Temperatures for laying at non harmonized Wires	265
Permissible laying temperatures and pull-forces for installation	266

Delivery and payment conditions

General delivery and payment conditions	267 / 268
---	-----------

Metal charges and ground plan

Metal charges	269 / 270
Ground plan	271

Drum overview

Conditions for the loan transfer of cable drums

1. The customer accepts liability, from the moment risk pertaining to the cable or wires is transferred, for the proper handling of the drums and is liable for damages in the event of damage or destruction – regardless of fault.
2. Empty drums are to be returned to us, carriage free.
3. If drums are returned to us within 6 months of the invoice date then there will be no rental fee or other costs charged.
4. From the 7th month to the end of the 11th month the drum rental amounts to 15% of the deposit value of the drum, as shown in the tables in the applicable price list, for each month or part thereof (i.e. 5 months = 75%).
5. Calculation of the drum rental is carried out after the drum is returned, or after 12 months have passed, whichever occurs first.
6. Drums that have not been released or returned after 12 months are charged at their full deposit value and pass into the ownership of the recipient.
7. We are prepared to take back empty drums that are returned outside of the period detailed above but within three years of delivery of the goods. For drums in good serviceable condition a refund of 25% of the deposit value will be paid. For damaged drums the credit note will be restricted by the amount of the refurbishment costs.
8. Costs for any additional cladding desired will be charged along with the cable delivery. Likewise, drums that were never intended for return (export). The deposit value is charged (see page 245).
9. Invoices for drum rental or purchase are payable strictly net within 30 days of receipt.
10. Steyr shall be the court of jurisdiction for any disputes, directly or indirectly related to the rental, that may arise.

Dimensions, Weights, Prices

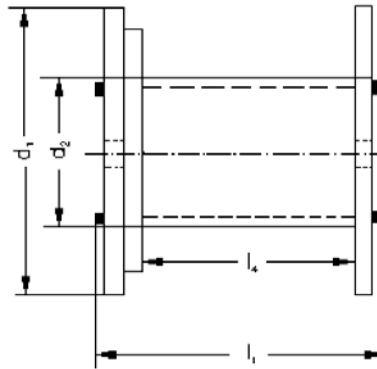

Drum nominal size	Flange-diameter d1	Core-diameter d2	Overall width l1	Winding width l4	Weight of drum approx.	Deposit value	Cladding costs
	mm	mm	mm	mm	kg	EUR	EUR
KTG - Plastic reels							
070	710	355	510	400	15	63,00	
080	800	400	510	400	16	81,00	
090	900	450	680	560	23	109,00	
100	1000	500	704	560	32	128,00	
KTG - Standard - wooden drums							
051	500	150	470	410	8	22,00	
061	630	150	490	315	13	31,00	9,00
071	710	355	520	400	25	42,00	11,00
081	800	400	520	400	31	53,00	13,00
091	900	450	690	560	47	68,00	15,00
101	1000	500	710	560	71	97,00	17,00
121	1250	630	890	670	144	183,00	41,00
141	1400	710	890	670	175	219,00	48,00
161	1600	800	1100	850	280	359,00	65,00
181	1800	1000	1100	840	380	465,00	88,00
201	2000	1250	1350	1045	550	690,00	123,00
221	2240	1400	1450	1140	710	878,00	164,00
250	2500	1400	1450	1140	875	1.055,00	205,00
251	2500	1600	1450	1130	900	1.055,00	205,00
281	2800	1800	1635	1280	1175	1.445,00	205,00
KTG - Wooden drums with steel rims							
078	710	355	520	400	28	48,00	
120	1250	630	890	670	165	208,00	
140	1400	710	890	670	199	259,00	
160	1600	800	1100	850	309	409,00	
180	1800	1000	1100	840	413	528,00	
200	2000	1000	1350	1060	600	765,00	
205	2000	1250	1350	1045	588	765,00	
220	2240	1120	1350	1050	750	951,00	
225	2240	1400	1450	1140	753	951,00	
255	2500	1400	1450	1140	923	1.134,00	
256	2500	1250	1350	1045	925	1.445,00	
285	2800	1800	1635	1280	1240	1.560,00	

Capacity of Cable Drums

Cable ∅	Lengths in m for drums with identification code and for drum sizes												
	061	071	081	091	101	121	141	161	181	201	221	250	251
6	1113	2024	2755										
7	845	1481	2340										
8	637	1064	1463	2731									
9	472	892	1152	2202	2866								
10	386	677	980	1768	2349								
11	314	564	761	1404	1912								
12	253	468	643	1206	1540								
13	237	385	542	1032	1339	2727							
14		364	454	881	1159	2265	2967						
15		297	430	749	1000	1991	2479						
16		239	358	632	860	1756	2205						
17		228	294	603	736	1545	1959						
18		218	281	505	705	1355	1737						
19		172	228	485	599	1184	1535	2722					
20		165	219	402	576	1139	1352	2435	2831				
21		159	211	387	485	991	1304	2172	2527				
22		122	167	315	468	856	1145	1931	2248				
23		117	161	304	389	827	999	1869	2172	2953			
24		113	156	294	377	709	967	1657	1927	2608			
25		110	151	285	365	688	839	1608	1867	2522			
26		80	116	226	299	668	814	1419	1650	2218			
27		78	113	221	290	567	700	1244	1450	2150	2861		
28		76	109	215	282	551	681	1211	1409	1879	2777		
29		73	106	209	226	462	663	1180	1371	1826	2450		2976
30		71	103	162	220	450	564	1028	1197	1583	2383		2893
31			76	157	214	438	550	1003	1166	1540	2089		2558
32			74	153	209	428	537	866	1009	1500	2035	2978	2491
33			72	150	204	352	451	846	985	1289	1984	2908	2428
34				146	158	344	441	828	962	1257	1726	2605	2134
35				108	154	336	431	707	824	1227	1685	2547	2083
36				105	151	329	422	692	806	1041	1646	2271	2035
37				103	148	265	348	678	788	1017	1418	2223	1774
38					144	259	341	664	772	994	1386	1969	1735
39					107	254	334	560	653	972	1356	1930	1697
40					105	249	327	549	640	812	1328	1892	1486
41					102	244	264	539	627	795	1130	1664	1435
42					100	190	259	529	615	779	1107	1633	1406
43						187	254	437	511	763	1085	1603	1199
44						183	249	430	502	749	1064	1574	1175
45						180	245	422	492	611	890	1373	1153
46						177	240	415	484	600	874	1349	1131
47						174	187	408	475	589	858	1326	1110
48						129	184	330	386	578	842	1144	931
49						127	181	325	380	568	828	1125	914
50						125	178	319	373	558	878	1107	898
51						123	175	314	367	442	666	1089	883
52						121	172	310	361	435	655	1072	869
53							170	305	356	428	644	912	713
54							126	230	280	421	634	898	701
55							124	235	276	414	624	885	690
56							122	232	271	408	614	872	679
57							121	228	267	401	488	860	668
58							119	225	263	304	480	719	658
59							117	222	260	300	473	709	649
60								219	256	295	466	699	639
61								216	252	291	460	689	609
62								161	190	287	453	680	501

Drum Assignment

The smallest admissible drum core diameter with reference to cable and wire types

Types	Smallest drum core diameter
Wires for fixed installation	
Single core wire	20 x D _A
Sheathed wires single core	20 x D _A
Sheathed wires multicore	15 x D _A
Flexible wires	12 x D _A
Cable plastic insulated	
Single core ≤ 6 kV	20 x D _A
Single core ≥ 10 kV	25 x D _A
Stranded, including 95 mm ² ≤ 1 kV	15 x D _A
Stranded, including 95 mm ² ≥ 6 kV	20 x D _A
Stranded, including 95 mm ² ≥ 20 kV	25 x D _A
Stranded, larger 95 mm ² ≤ 10 kV	20 x D _A
Stranded, larger 95 mm ² ≥ 20 kV	25 x D _A
Multicore ≤ 1 kV	15 x D _A
Telecommunication cables and installation cables for telecommunications systems	
Plastic cables	20 x D _A
Installation cables	20 x D _A
Paper insulated cables with lead outer sheath	
Single core ≤ 10 kV	25 x D _A
Single core ≥ 10 kV	30 x D _A
Multicore, unarmoured ≥ 6 kV	25 x D _A
Multicore, armoured ≥ 6 kV	20 x D _A
Three-core SL type cable armoured ≥ 10 kV	20 x D _A

D_A = cable or wire diameter

Conductor Construction for Insulated Cables and Wires

Conductor Construction

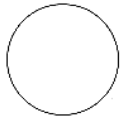

circular
solid
RE

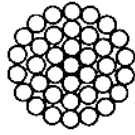

circular
stranded
RM

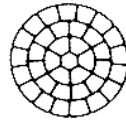

circular
stranded
compacted
RM



sector-shaped
solid
SE

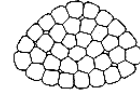

sector-shaped
stranded
SM

Construction and Conductor Resistance according DIN EN 60228 (VDE 0295)

Circular copper conductor

nominal cross section mm ²		max. conductor resistance at 20°C bare metal Ohm / km sheathed Ohm / km		solid (class 1) max. conductor diameter mm	stranded (class 2)			
					not compacted		compacted	
					number of single wires (min.)	max. conductor diameter	number of single wires (min.)	conductor diameter minimum mm maximum mm
0,5	36,0	36,7	0,9	7	1,1			
0,75	24,5	24,8	1,0	7	1,2			
1	18,1	18,2	1,2	7	1,4			
1,5	12,1	12,2	1,5	7	1,7			
2,5	7,41	7,56	1,9	7	2,2			
4	4,61	4,7	2,4	7	2,7			
6	3,08	3,11	2,9	7	3,3			
10	1,83	1,84	3,7	7	4,2			
16	1,15	1,16	4,6	7	5,3			
25	0,727	0,734		7	6,6	6	5,6	6,5
35	0,524	0,529		7	7,9	6	6,6	7,5
50	0,387	0,391		19	9,1	6	7,7	8,6
70	0,268	0,270		19	11,0	12	9,3	10,2
95	0,193	0,195		19	12,9	15	11,0	12,0
120	0,153	0,154		37	14,5	18	12,3	13,5
150	0,124	0,126		37	16,2	18	13,7	15,0
185	0,0991	0,100		37	18,0	30	15,3	16,8
240	0,0754	0,0762		61	20,6	34	17,6	19,2
300	0,0601	0,0607		61	23,1	34	19,7	21,6
400	0,0470	0,0475		61	26,1	53	22,3	24,6
500	0,0366	0,0369		61	29,2	53	25,3	27,6
630	0,0283	0,0286		91	33,2	53	28,7	32,5
800	0,0221	0,0224		91	37,6	-	-	-
1000	0,0176	0,0177		91	42,2	-	-	-

Sector-shaped copper conductor

nominal cross-section mm ²	max. conductor resistance at 20°C Ohm / km	stranded (class 2) compacted	nominal cross-section mm ²	max. conductor resistance at 20°C Ohm / km	stranded (class 2) compacted
		number of single wires (min.)			number of single wires (min.)
25	-	-	150	0,124	18
35	0,524	6	185	0,0991	30
50	0,387	6	240	0,0754	34
70	0,268	12	300	0,0601	34
95	0,193	15	400	0,0470	53
120	0,153	18	500	-	-

Fine-stranded and very fine stranded copper conductor

nominal cross-section mm ²	max. conductor resistance at 20°C		max. conductor diameter	number & largest diameter of single wire	
	bare Ohm / km	metal-sheathed Ohm / km		fine- and very fine stranded mm	fine-stranded (class 5) mm
0,5	39,0	40,1	1,1	12 x 0,21	28 x 0,16
0,75	26,0	26,7	1,3	24 x 0,21	42 x 0,16
1	19,5	20,0	1,5	32 x 0,21	56 x 0,16
1,5	13,3	13,7	1,8	30 x 0,26	84 x 0,16
2,5	7,98	8,21	2,6	50 x 0,26	140 x 0,16
4	4,95	5,09	3,2	56 x 0,31	224 x 0,16
6	3,30	3,39	3,9	84 x 0,31	192 x 0,21
10	1,91	1,95	5,1	80 x 0,41	320 x 0,21
16	1,21	1,24	6,3	128 x 0,41	512 x 0,21
25	0,780	0,795	7,8	200 x 0,41	800 x 0,21
35	0,554	0,565	9,2	280 x 0,41	1120 x 0,21
50	0,386	0,393	11,0	400 x 0,41	705 x 0,31
70	0,272	0,277	13,1	356 x 0,51	990 x 0,31
95	0,206	0,210	15,1	485 x 0,51	1340 x 0,31
120	0,161	0,164	17,0	614 x 0,51	1690 x 0,31
150	0,129	0,132	19,0	765 x 0,51	2123 x 0,31
185	0,106	0,108	21,0	944 x 0,51	1470 x 0,41
240	0,0801	0,0817	24,0	1225 x 0,51	1905 x 0,41
300	0,0641	0,0654	27,0	1530 x 0,51	2385 x 0,41
400	0,0486	0,0495	31,0	2035 x 0,51	-
500	0,0384	0,0391	35,0	1768 x 0,61	-

Aluminium conductor

nominal cross-section mm ²	max. conductor re- sistance at 20°C Ohm / km	circular conductor (class 2) stranded ¹ , compacted			sector-shaped conduc- tor (class 2) stranded ² , compactd
		number of single wires (min.)	conductor diameter		number of single wires (min.)
			minimum (mm)	maximum (mm)	
25	1,20	6	5,6	6,5	6
35	0,868	6	6,6	7,5	6
50	0,641	6	7,7	8,6	6
70	0,443	12	9,3	10,2	12
95	0,320	15	11,0	12,0	15
120	0,253	15	12,5	13,5	15
150	0,206	15	13,9	15,0	15
185	0,164	30	15,5	16,8	30
240	0,125	30	17,8	19,2	30
300	0,100	30	20,0	21,6	30
400	0,0778	53	22,9	24,6	53
500	0,0605	53	25,7	27,6	-
630	0,0469	53	29,3	32,5	-

¹⁾ Single core circular conductor (class1) are permissible till 300 mm². The diameter of the non compacted conductor from 25 mm² till 630 mm² is to be taken from DIN EN 60332.

²⁾ Single core sector-shaped conductors (class1) are permissible from 50 mm² till 240 mm²

Conversion table for standard cross-sections

Comparison between the metrical and the American standard cross sections

AWG No.	Wire-Ø mm	Wire cross section	Conductor resistance max. Ohm/km	AWG Nr.	Wire-Ø mm	Wire cross section	Conductor re- sistance max. Ohm/km
28	0,320	0,0804	229	14	1,630	2,08	8,50
27	0,361	0,102	181	13	1,830	2,63	7,30
26	0,404	0,128	146	12	2,050	3,31	5,75
25	0,455	0,162	114	11	2,300	4,17	4,54
24	0,511	0,205	84	10	2,588	5,261	3,59
23	0,574	0,259	67	9	2,906	6,631	2,99
22	0,643	0,324	54	8	3,264	8,367	2,25
21	0,724	0,412	43	7	3,665	10,55	1,79
20	0,813	0,519	34	6	4,115	13,30	1,42
19	0,912	0,653	27	5	4,620	16,77	1,12
18	1,020	0,823	21	4	5,189	21,15	0,89
17	1,150	1,04	16,90	3	5,827	26,67	0,70
16	1,290	1,31	13,50	2	6,543	33,62	0,56
15	1,450	1,65	10,60	1	7,348	42,41	0,44

Rating as per the National Electrical Code (NEC)

Extract from NEC Table 310-16

Permissible current ratings for single insulated copper conductors, nominal voltage from 0 to 2000 V, 60°C-90°C.

Not more than three loaded cores laid in one cable duct or in a multicore cable or in the ground.

Based on ambient temperature of 30°C

Extract from NEC Table 310-17

Allowable Ampacities of single insulated conductors, nominal voltage from

0-2000 V, on Air,

Based on Ambient Temperature of 30°C

nominal cross section AWG	Rating [A] Temperature Rating of Conductor		
	60°C	75°C	90°C
18	-	-	14
16	-	-	18
14	20*	20	25
12	25*	25*	30
10	30	35*	40
8	40	50	55
6	55	65	75
4	70	85	95
3	85	100	110
2	95	115	130
1	110	130	150
1/0	125	150	170
2/0	145	175	195
3/0	165	200	225
4/0	195	230	260
250	215	255	290
300	240	285	320
350	260	310	350
400	280	355	380
500	320	380	430
600	355	420	475

nominal cross section AWG	Capacitance [A] Temperature Rating of Conductor		
	60°C	75°C	90°C
18	-	-	18
16	-	-	24
14	25*	30*	35*
12	30*	35*	40*
10	40*	50*	55*
8	60	70	80
6	80	95	105
4	105	125	140
3	120	145	165
2	140	170	190
1	165	195	220
1/0	195	230	260
2/0	225	265	300
3/0	260	310	350
4/0	300	360	405
250	340	405	455
300	375	445	505
350	420	505	570
400	455	545	615
500	515	620	700
600	575	690	780

* Note

Unless otherwise specifically permitted in this Code, the over current protection for conductor types marked with a star shall not exceed 15 amperes for No. 14, 20 amperes for No. 10 copper, after any correction factors for ambient temperature and number of conductors have been applied.

Insulation and Sheath Materials

Overview of the most important polymers used in cable technology

thermoplastics (plastomere)		cross-linked thermoplast		thermoplastic elastomere	elastomere		duroplastic (duromere)	
PVC	polyvinylchloride	XLPE (VPE)	cross.linked polyethylene	blends of polyolefinens and rubber	NR	natural rubber	EP	epoxy resin
PE	polyethylene		cross-linked ethylene-copolymere	Three-masspolymere (Styrol-Alkylen-Styrol)	EPM	ethylene-propylene-rubber compounds	PUR	polyurethane resin
EVA	ethylene-vinylacetate-copolymere (VA < 30%)			thermoplastic polyurethane (PUR) and polyester	SBR	Styrol-butadiene-rubber compounds		
EEA	ethylene-alkylacrylate-copolymer, e.g.: ethylene-ethylakrylate				EPDM	ethylene-propylene-terpolymer-rubber compounds		
EBA	ethylene-butylakrylate							
PP	polypropylene				IIR	butyl rubber		
PA	polyamide				CR	Polychloropren compounds		
ETFE	ethylene-tetrafluoric-ethylen-copolymere				EVA	ethylene-vinylacetate-copolymer (VA > 30%)		
FEP	tetrafluor-ethylene-hexafluor-propylene-copolymere				CSM	Chloro-sulfonated polyethylene compounds		
					CM	chlorinated polyethylene		
					SiK	silicone rubber		
					ECO	epichlorhydrin-rubber comp.		
					NBR	nitril-butadiene-rubber compounds		

Mechanical, Thermal, Electrical and Chemical Properties of Insulation and Sheath Materials

Designations			Properties (guide values)																						
symbol	chemical	VDE	permissible operating temperature to VDE C°	mechanical			behaviour at low temperature	thermal		corrosive gases during a combustion	electrical			chemical resistance (guide values)											
				tensile strength	elongation mm	resistance to abrasion		flame resistance	hydrogen chloride		specific volume resistance	permittivity constant	factor of loss	oils - fats	solvents	diluted acids	water								
	Thermoplastic																								
PVC	polyvinylchloride compounds	Y	70-105	12.5-25	125-350	average to good	average to good	average to good	hydrogen chloride	10 ¹² - 10 ¹⁵	4,0-6,5	10 ⁻² - 10 ⁻³	moderate to average	average	good	moderate									
LDPE	low-density – polyethylene	2Y	70,00	10-20	400-600	average	good	bad	-	> 10 ¹⁶	2,25-2,6	~ 10 ⁻⁴	moderate	moderate	very good	very good									
HPE	high-density – polyethylene	2X	90,00	25-40	500-1000	good	good	bad	-	> 10 ¹⁶	2,4-2,5	~ 10 ⁻⁴	moderate	moderate	very good	very good									
VPE	cross-linked polyethylene	2X	90,00	12,5-20	300-450	average	good	bad	-	~ 10 ¹⁶	2,3-2,6	~ 10 ⁻⁴	moderate	moderate	very good	very good									
	foamed polyethylene	02Y	70,00	8-12	350-500	-	good	bad	-	~ 10 ¹⁷	~ 1,6	~ 10 ⁻⁴	moderate	moderate	very good	very good									
PA	polyamide	4Y	80,00	50-60	50-200	very good	good	good	-	~ 10 ¹⁵	~ 4,0	~ 10 ⁻² - 10 ⁻³	very good	good	very good	moderate									
PUr	polyurethane	11Y	80,00	35-50	500-700	very good	good	moderate	-	~ 10 ¹²	~ 6,0	~ 10 ⁻²	good	good	average	moderate									
	Elastomers																								
NR	natural rubber																								
SR	styrol – butadien – rubber	G	60,00	5,0-10,0	300-600	moderate to average	very good	bad	-	**	**	**	bad	bad	moderate	moderate									
SIR	silicone rubber	2G	180,00	5,0-10,0	300-600	moderate	very good	average to good	-	~ 10 ⁻¹⁵	~ 3,0	~ 10 ⁻³	good	bad	average	very good									
EPR	ethylene – propylene rubber compounds	3G	90,00	5,0-10,0	300-500	moderate to average	good	average to bad	-	~ 10 ¹² - 10 ⁻¹⁵	3,0 - 3,8	~ 10 ⁻² - 10 ⁻³	moderate to average	average	good	very good to good									
EVM	ethylene – vinylacetate - Copolymer compounds	4G	120,00	8,0-12,0	200-350	moderate to average	good	average to moderate	-	~ 10 ¹³	~ 6,0	~ 10 ⁻²	moderate to average	average	moderate	moderate									
CR	polychloroprene compounds	5G	60-90	5,0-20,0	500-800	average to good	average to good	good	hydrogen chloride	**	**	**	good to very good	good	good	average									
CM	chlorinated polyethylene compounds	9G	80-100	8,0-20,0	350-650	average to good	average	good	hydrogen chloride	**	**	**	good to very good	good	good	average									
GSM	chlorosulfonated polyethylene compounds	6G	100,00	8,0-20,0	400-700	average to good	average	good	hydrogen chloride	**	**	**	good to very good	good	good	average									
	Special Compounds																								
ohne	cross-linked flame retardant halogen-free polymere	H	70-90	5,0-1,2	> 125	moderate to average	moderate	good to very good	-	-10 ¹³ - 10 ¹⁴	~ 4	10 ⁻² - 10 ⁻³	moderate to average	average	good	good									
ohne	flame retardant halogen-free polymere, not cross-linked	H	70-90	5,0-1,2	> 125	moderate to average	moderate	good	-	-10 ¹² - 10 ¹⁴	~ 4	~ 10 ⁻³	moderate	moderate	gut	moderate									

Abbreviations Key for wires according to harmonized requirements

Type of designation and rated voltage	Designation ident	1. Part	2. Part	3. Teil
	harmonized type	H		
	acknowledged national type	A		
	Rated voltage U₀ / U			
	100 / 100 V	01		
	300 / 300 V	03		
	300 / 500 V	05		
	450 / 750 V	07		
Structure of the wires	Insulation material			
	PVC standard to + 70 °C	V		
	PVC heat resistant to + 90 °C	V2		
	PVC cold resistant to - 25 °C	V3		
	PVC cross- linked	V4		
	natural and /or synthetic rubber to + 60 °C	R		
	ethylene-propylene rubber to + 90 °C	B		
	synthetic rubber (EVA) to + 110 °C	G		
	silicone rubber heat resistant to + 180 °C	S		
	cross-linked halogen free compound	Z		
	halogen free thermoplastic compound	Z1		
	Sheath material			
	PVC standard to + 60 °C	V		
	PVC heat resistant to + 90 °C	V2		
	PVC cold resistant to - 25 °C	V3		
	PVC cross-linked	V4		
	PVC oil resistant	V5		
	polyurethane	Q		
	natural and / or synthetic rubber to + 60 °C	R		
	polychloroprene rubber to + 60 °C	N		
	special polychloroprene rubber compound	N2		
	synthetic rubber (EVA) to + 110 °C	G		
	fibreglass braid	J		
	textile braid	T		
	textile braid with flame retardant compound	T2		
	Spezial constructions			
	divisible flat cable	H		
	indivisible flat cable	H2		
	flat cable acc. to HD 359 with ≥ 3 cores	H6		
	spiral cables	H8		
	supporting element (textile or metal)	D3		
	Core inlet (no load-bearing element)			
	copper braid screen over stranded cores	C4		
	construction of conductor			
	solid	-U		
	stranded	-R		
	fine stranded for fixed installation	-K		
	fine stranded for flexible installation	-F		
	very fine stranded for flexibel installation	-H		
	tinsel cord	-Y		
	fine stranded conductor for welding cables	-D		
	very fine stranded conductor for welding cables	-E		
number of cores and nominal cross section	number of cores	...		
	earth conductor			
	without earth conductor	X		
	with earth conductor (yellow green)	G		
	nominal cross section in mm²	...		

Examples of construction type abbreviations:

H07V-U 1,5 black	PVC-insulated Single Core Wire 1,5 mm ² , black with solid conductor
H07RN-F 3 G 2,5	Rubber Sheathed Cable, 3 cores, 2,5 mm ² , with earth conductor yellow green
H03VV-F 2 x 0,75	PVC Sheathed Wire, 2 cores, 0,75 mm ²

Abbreviations key for electricity cables

Constructing components	abbreviations		remark
	VDE	ÖVE	
National standard	N	-	
Adapted to the national standard	(N)	E-	E ... energy cable
conductor			
- of copper	-	-	no sign
- of aluminium	A	A	
Insulation			
- mass-impregnated paper	-	P	
- polyvinylchloride (PVC)	Y	Y	
- polyethylene (PE)	2Y	2Y	
- cross-linked polyethylene (VPE)	2X	2X	
- cross-linked polymer (flame retardant, halogen free)	HX	-	
Concentric conductor of copper			
- long-lay	C	C	
- in waveconal formation	CW	-	
Screen of copper			
- for single core cables or for multicore cables with a common screen	S	C	
- for multicore cables with a screen over each individual core	SE	CE	
- longitudinally watertight	S(F)	CJ	XLPE power cables
Individual screening of cores from metalised paper (Höchstädter Cable)	H	H	
Metal sheath of lead			
- for single core and multicore cables with a common sheath	K	M	
- for 3-core screened SL cables with an anti-corrosion protection on each sheath	EK	ME	
Polymer laminated sheath			
- longitudinally and radially with aluminium tape tightly bonded to the PE sheath	(FL)2Y	JA2Y	
Plastic sheath and inner protection			
- PVC sheath or extruded PVC protection	Y	Y	
- PVC (reinforced sheath)	YV	Y3V	
- PE sheath	2Y	2Y	
- PE (reinforced sheath)	2YV	2Y3V	
- FRNC	HX	NG	cross-linked polymer
- FRNC	H	NY	not cross-linked polymer
Armour			
- steel tape	B	B	
- flat steel tape	F	F	
- round steel tape	R	R	
- counter helix of galvanized steel tape	G	G	
- Aldrey - circular wires	R(Ay)	R(Ay)	
External protection			
- Compound jute fibre	A	U	
- further materials: compare inner protection			
Constructions			
- with yellow green core	-J	-J	with protective conductor
- without yellow green core	-O	-O	without protective conductor
- core colouring with numbers - construction J	-JZ	-JZ	with protective conductor
- core colouring with numbers - construction O	-OZ	-OZ	without protective conductor
Conductor design			
- circular solid	RE	RE	
- circular stranded	RM	RM	compacted or incompact
- fine stranded	F	F	
- sector shaped solid	SE	SE	
- sector shaped stranded	SM	SM	

Cables are designated with

- type abbreviation
- number of cores and nominal cross section in mm²
- abbreviation for type & form of the main conductor
- if applicable nominal cross section of the screen or the concentric conductor in mm²
- nominal voltage in kV

Cables are not designated with

- copper conductor
- insulation of impregnated paper
- inner and outer conducting layer for cables with plastic insulation
- common core covering
- filling material
- inner serving of compounded jute yam

Abbreviations key for telecommunication cables

Construction components	VDE	ÖVE
Type		
- telecommunication cable	-	F
- outdoor cable	A	-
- outdoor cable with a construction for lightning protection	AB	-
- mining cable	G	-
- installation cable	J	-
- signal cable	S	-
Tinned conductor	-	v
Core insulation		
- PVC, polyvinylchloride	Y	Y
- PE, polyethylene	2Y	2Y
- foamed PE, foamed polyethylene	O2Y	-
Stranding components		
- stranded in pairs	P	-
- stranded in pairs with an individual static screen	P(ST)	-
- pairs in a metal foil	PiMF	-
- coaxial pair	KxP	-
- multiple twin-quad stranding (Dieselhorst-Martin)	DM	-
- star quad with use of phantom circuits	St	-
- star quad for short-range cables	STI	-
- star quad in subscriber's cables	STIII	-
- stranding in layers	Lg	-
- stranding in bundles	Bd	-
Armouring and screening		
- screen of copper tape over a PE inner sheath	K	-
- screen of copper tape	-	C
- screen of plastic coated aluminium foil	St	A
- earth wire	-	E
Sheath and protection sheath		
- lead sheath	M	-
- lead sheath with a hardening addition	Mz	-
- PVC sheath or protection sheath	Y	Y
- reinforced PVC protection sheath	Yv	Y3V
- PE sheath or protection sheath	2Y	2Y
- reinforced PE protection sheath	2Yv	2Y3V
- composite-layer sheath	(L)2Y	A2Y
- longitudinally and radially with aluminium tape tightly bonded to the PE sheath	(FL)2Y	JA2Y
- protection sheath made of jute and viscous mass	c	-
- filling of the interstices with petrol jelly	F	J
- steel tape	-	B
- flat wire	-	F
- round wire	-	R
- counter helix	-	G
Supporting element	-	T

Colour-Coding for Cables and Wires

Old schema of colour-coding acc.
harmonized document HD 308 S1

**New schema of colour-coding acc.
harmonized document HD 308 S2
valid from 1.4.2006**

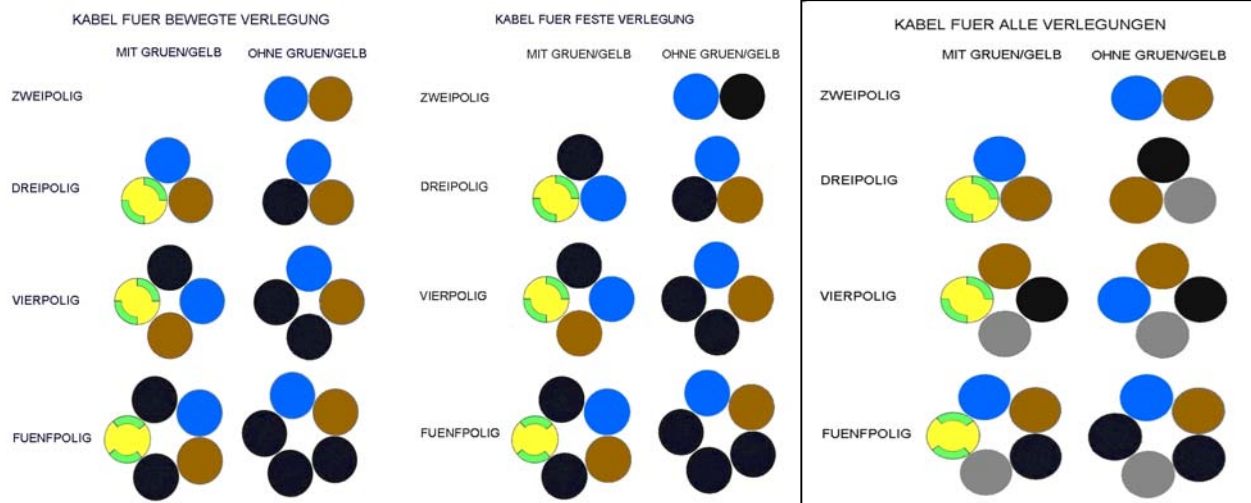

From six core: - J - Construction: 1 green-yellow core, further cores back with embossed numbering
- O - construction: All cores back with embossed numbering

Exceptions: a) 4-core with green-yellow alternative only for particular applications: Green-yellow, blue, brown, black
a) 3-core without green-yellow alternative only for particular applications: Blue, brown, black

What are the principal enhancements of the new system?

The principal enhancement is the introduction of the "grey" core colour for an outer conductor. The colours and the colour sequences in the cable are shown in the tables above. **The arrangement of the core colours for earth conductors and neutral lines is unchanged, that is: green-yellow and blue.**

DIN VDE 0293-308 (VDE 0293 part 308): 2003-01 provides for 2 exceptions whereby these variants, marked with the footnote "a)" or "b)", are applicable only for particular applications. These special applications are defined in DIN EN 60446 (VDE 0198): 1999-10, section 3.2.2. Accordingly for particular applications where there is no danger of confusion and no neutral line existing in the system, the blue core can be used as external conductor. However, no colour other than blue may be used for the neutral line. The colour light-blue is generally replaced by blue in this colour system.

Transitional period between old and new system with identification of cable cores and wires through colours

In general, standards cover comparable products. By referring to product standards in contracts it is possible to dispense with a considerable proportion of specification details. However there are exceptions, namely in the case of transitional periods with revised standards or "replacement standards" contingent on harmonisation. In this case the old and the new definitions are equally valid during the agreed transitional period. This applies also for the core identification of cables and wires. By harmonising the core colours of cables and wires through the installation technology standards committees, the wiring industry was granted the time period of 01.10.2001 to 01.04.2006, to change over its product range to the new core colours and to dispose of their existing stock with the old identification.

During the transitional period users of the cable and wiring, and the dealers, have the opportunity to complete projects that they have already started with the previously used products and reduce old stocks correspondingly. The electrical trade have indicated that from their side there should be no difficulties in effecting the changeover. The cable manufacturers intend to carry out the changeover as quickly as possible, but due to the various different operational conditions it is not possible to nominate a harmonised changeover date. The rough target for this is the end of 2003 so that from 01.01.2004 the proportion of products on the market with the new core identification system will increase sharply.

Core colour-coding of PVC control lines with 6 or more coloured cores

(In accordance with DIN VDE 293)

Core no.	Colour	Core no.	Colour	Core no.	Colour	Core no.	Colour	Core no.	Colour	Core no.	Colour
0	yellow-green	17	pink - white	34	orange-blue	51	transp. red	68	transp. white-black	85	beige-white-brown
1	white	18	orange-white	35	transp.-blue	52	beige-red	69	beige-white-black	86	red-white-grey
2	black	19	transp.-white	36	beige-blue	53	pink-violet	70	brown-white-blue	87	violet-white-grey
3	blue	20	beige-white	37	grey-brown	54	orange-violet	71	brown-white-blue	88	pink-white-grey
4	brown	21	blue-black	38	red-brown	55	transp.-violet	72	grey-white-blue	89	orange-white-grey
5	grey	22	brown-black	39	violet-brown	56	beige-violet	73	red-white-blue	90	transp-white-grey
6	red	23	grey-black	40	pink-brown	57	transp.-pink	74	violet-white-blue	91	beige-white-grey
7	violet	24	red-black	41	orange-brown	58	beige-pink	75	pink-white-blue	92	blue-white-red
8	pink	25	violet-black	42	transp.-brown	59	transp.-orange	76	orange-white-blue	93	brown-white-red
9	orange	26	pink-black	43	beige-brown	60	beige-orange	77	transp-white-blue	94	violet-white-red
10	transparent	27	orange-black	44	red-grey	61	blue-white-black	78	beige-white-blue	95	pink-white-red
11	beige	28	transp.-black	45	violet-grey	62	brown-white-black	79	grey-white-brown	96	orange-white-red
12	black-white	29	beige-black	46	pink-grey	63	grey-white-black	80	red-white-brown	97	brown-white-violet
13	brown-white	30	brown-blue	47	orange-grey	64	red-white-black	81	violet-white-brown	98	orange-white-violet
14	grey-white	31	grey-blue	48	transp.-grey	65	violet-white-black	82	pink-white-brown	99	brown-black-blue
15	red-white	32	red-blue	49	beige-grey	66	pink-white-black	83	orange-white-brown	100	grey-black-blue
16	violet-white	33	pink-blue	50	orange-red	67	orange-white-black	84	transp-white-brown	101	red-black-blue

Example core colours :

YSLY-JB 12 x 1.5: yellow/green, white, black, blue, brown, grey, red, violet, pink, orange, transparent, beige

YSLY-OB 12 x 1.5: white, black, blue, brown, grey, red, violet, pink, orange, transparent, beige, black/white

Colour-Coding for Electronic Cables LiYY and LiYCY, acc. to DIN 47100 or factory standard

Core stranding				pairwise stranding				
Core-No.	Core colour	Core-No.	Core colour	Pair-No.			Core colour	
							a-core	b-core
1	white	23	white-red	1	23	45	white	brown
2	brown	24	brown-red	2	24	46	green	yellow
3	green	25	white-black	3	25	47	grey	pink
4	yellow	26	brown-black	4	26	48	blue	red
5	grey	27	grry-green	5	27	49	black	violet
6	pink	28	yellow-grey	6	28	50	grey-pink	red-blue
7	blue	29	pink-green	7	29	51	white-green	brown-green
8	red	30	yellow-pink	8	30	52	white-yellow	yellow-brown
9	black	31	green-blue	9	31	53	white-grey	grey-brown
10	violet	32	yellow-blue	10	32	54	white-pink	pink-brown
11	grey-pink	33	green-red	11	33	55	white-blue	brown-blue
12	blue-red	34	yellow-red	12	34	56	white-red	brown-red
13	white-green	35	green-black	13	35	57	white-black	brown-black
14	brown-green	36	yellow-black	14	36	58	grey-green	yellow-grey
15	white-yellow	37	grey-blue	15	37	59	pink-green	yellow-pink
16	yellow-brown	38	pink-blue	16	38	60	green-blue	yellow-blue
17	white-grey	38	grey-red	17	39	61	green-red	yellow-red
18	grey-brown	40	pink-red	18	40	62	green-black	yellow-black
19	white-pink	41	grey-black	19	41	63	grey-blue	pink-blue
20	pink-brown	42	pink-black	20	42	64	grey-red	pink-red
21	white-blue	43	blue-black	21	43	65	grey-black	pink-black
22	brown-blue	44	red-black	22	44	66	blue-black	red-black

For more cores than listed the colour sequence is repeated. The first colour is the basic colour, the second colour is he colour of the ring is marking. The distance between two rings is app. 7 mm. For the 4-core type differs from this pattern because the colours are white, yellow, brown and green.

JE-LiYCY und JE-Y(ST)Y acc. to DIN 57815

pair	1	2	3	4
a-core	blue	grey	green	white
b-core	red	yellow	brown	black

The cores are marked with the basic colour of the insulation which is repeated in the same sequence at each bundle.

Identification of the bundle - variante 1 "Bd Z"

The bundles (4 pairs each) are clearly to be identified by a number helix.

Identification of the bundle - variante 2 "Bd Si"

bundle-No.	Colour of rings	Group of rings	helix
1	pink	I	-
2		II	
3		III	
4		IIII	
5	orange	I	-
6		II	
7		III	
8		IIII	
9	violet	I	-
10		II	
11		III	
12		IIII	
13	pink	I	blue
14		II	
15		III	
16		IIII	
17	orange	I	red
18		II	
19		III	
20		IIII	

The bundles are counted from inside to outside.

Ringidentification (group of rings)

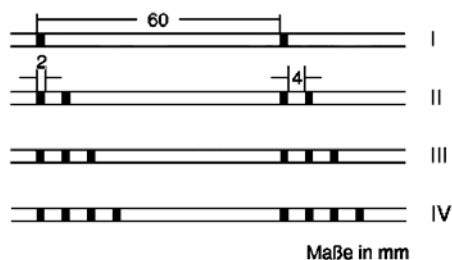

Core Colouring of the Telecommunication Cables according to VDE

J-Y(ST)Y	J-YY
<p>For the 2-paired installation cables:</p> <p>1. pair a-core red, b-core black 2. pair a-core white, b-core yellow</p> <p>For all other cables:</p> <p>a-core 1st pair each layer red, at all the other pairs white;</p> <p>b-core blue, yellow, green, brown, black, colours are repeated</p> <p>Counting from outside to inside</p>	<p>The cores are to be identified by rings</p> <p>circuit 1 a-core without rings</p> <p>b-core ■ ■ ■</p> <p>circuit 2 a-core ■ ■ ■ ■ ■</p> <p>b-core ■ ■ ■ ■ ■</p> <p>The basic colours of the insulation sheath of the 5 star quads of a bundle</p> <p>quad 1 red quad 2 green quad 3 grey quad 4 yellow quad 5 white</p> <p>The tracer bundles are marked by a red helix.</p>

Layer Stranding of Installation Cables J-Y (ST) Y

Number of pairs	Number of pairs in layers					
	1	2	3	4	5	6
2	2					
4	4					
5	6					
10	2	8				
16	5	11				
20	1	6	13			
24	2	8	14			
30	4	10	16			
40	1	7	13	19		
50	4	10	15	21		
60	1	6	12	18	23	
100	2	8	14	20	25	31

A-2Y(L)2Y	A-2YF(L)2Y
<p>The cores are to be identified by rings</p> <p>circuit 1 a-core without rings</p> <p>b-core ■ ■ ■</p> <p>circuit 2 a-core ■ ■ ■ ■</p> <p>b-core ■ ■ ■ ■ ■ ■</p> <p>The basic colours of the insulation sheath of the 5 star quads of a basic bundle:</p> <p>quad 1 red quad 2 green quad 3 grey quad 4 yellow quad 5 white</p> <p>The tracer bundles are marked by a red helix.</p>	<p>The cores are to be identified by rings</p> <p>circuit 1 a-core without rings</p> <p>b-core ■ ■ ■</p> <p>circuit 2 a-core ■ ■ ■ ■</p> <p>b-core ■ ■ ■ ■ ■ ■</p> <p>The basic colours of the insulation sheath of the 5 star quads of a basic bundle:</p> <p>quad 1 red quad 2 green quad 3 grey quad 4 yellow quad 5 white</p> <p>The tracer bundles are marked by a red helix.</p>

Core Colouring of the Telecommunication Cables according to ÖVE [Austrian association of electrical engineers]

YR *
YYSch *
JB-YY *
* core colours acc. to the factory norm

F-vYAY, F-YAY						
pair-No.	colour of a-core	colour of b-core				
		blue	yellow	green	brown	black
1 ... 5	white-blue	1	2	3	4	5
6 ... 10	white-yellow	6	7	8	9	10
11 ... 15	white-green	11	12	13	14	15
16 ... 20	white-brown	16	17	18	19	20
21 ... 25	white-black	21	22	23	24	25
26 ... 30	red-blue	26	27	28	29	30
31 ... 35	red-yellow	31	32	33	34	35
36 ... 40	red-green	36	37	38	39	40
41 ... 45	red-brown	41	42	43	44	45
46 ... 50 *	red-black	46	47	48	49	50

* From the 51st pair the colour sequence is repeated.

F-2YA2Y, F-2YC2Y, F-2YJA2Y

The cores are stranded in star quads. Two opposite cores of a quad build a talking circuit.

core identification in a quad :

circuit 1	a-core ... natural b-core ... red
circuit 2	c-core ... green d-core ... blue

One quad is marked as a tracer quad with a black a-core in each layer.

Number of star quads in each layer

number of		number of star quads in each layer					
quads	pairs	1	2	3	4	5	6
25	50	3	8	14			
50	100	4	10	15	21		
75	150	3	9	15	21	27	
100	200	2	8	14	20	25	31

Core Colouring of the Data Transmission Cables Category 5

Colour-code according to IEC 708-1

Cable element	a-core		Colour of the insulation sheath		b-core			
1	white	(-blue)			blue			
2	white	(-orange)			orange			
3	white	(-green)			green			
4	white	(-brown)			brown			
5	white				grey			
6	red				blue			
7	red				orange			
8	red				green			
9	red				brown			
10	red				grey			
Counting in pairs (to 10 pairs)								
Cable element	a-core		b-core		Colour of the insulation sheath		c-core	d-core
1	white		blue		turquoise		violet	
2	white		orange		turquoise		violet	
3	white		green		turquoise		violet	
4	white		brown		turquoise		violet	
5	white		grey		turquoise		violet	
Counting in quads (to 5 quads)								

Guidelines for laying wiring in energy chains

Great care must be taken when laying wiring in energy chains.

As a matter of principle the following points should be adhered to:

1. The wires should be laid individually, loosely beside one another, insofar as this is possible. If wires of different diameters are being laid on top of each other or beside each other then it is recommended to use separating stays.
2. Permanently flexible wiring with an outer diameter < 10 mm, with which a separation using stays is not possible, should be gathered loosely together, arranged in a flexible conduit and laid in the energy supply chain. The diameter of the flexible conduit selected should be substantially larger than the sum of the individual cable diameters.
3. The wires must be able to move freely in the frame stays. For safety, 10% of the wiring diameter should be provided as free space.
4. It is necessary to carefully ensure that the wiring can pass through the curve radii without any constraint. Also with multi-layer laying the wires must have sufficient free space between one another through the curve radii.
5. The wires must be laid in the energy chain in such a way that they are not contorted (no twists). Therefore the wires must be unrolled from the drum or ring before laying (do not lift wires off in coils).
6. The weight distribution in the chain or in the chain stays should be symmetrical as far as possible. Heavy wires should be laid outwards, lighter supply lines towards the centre.
7. All wires must be strain-relieved at anchoring points and attachments. In doing so it must be ensured that the pressure on the outer sheath is spread over a large surface area. The clamping must be carried out carefully such that the cores in the wires are not crushed and yet that the wires are no longer able to slide.
8. In principle, only permanently flexible wiring should be used. It is essential to comply with the permitted bend radii.
9. When installing and laying energy chains the following standards (amongst others) must be complied with:

DIN VDE 0100

DIN VDE 0113

Instructions for transportation, storage and laying of category 5, category 6 or category 7 data cables

The LAN cabling must be protected from damage and moisture ingress.

This includes:

- Careful transportation (do not expose cable reel to any shock loading).
- Proper storage
- Provide end caps for ends
- Comply with storage and laying temperatures
- Checking the cable paths and preparing them for the wiring, i.e. smoothing, deburring, modifying bend radii etc. if necessary
- Use appropriate tools.
- Comply with permissible bend radii and draw forces (per corresponding table)
- Draw / reel cable off rotating reel (tangentially), never over the flange (head) or from the ring, in order to minimise torsion damage.
- Attach pressure relief devices (props) rather than having the coverings in direct contact with the cables.
- With flat wiring the bending is to be carried out on the small diameter.
- In order to comply with the EMC requirements (EN 55022) it is necessary to connect the screens all the way through.

Permissible Bending Radii for Laying on 20°C (+/-10°C)

for harmonized wires acc. HD 516 S2:1997 + A1:2003 (DIN VDE 0298-300)

Wires for fixed installation (HD21 / HD22)

Nominale voltage to 0,6 / 1kV	Cable diameter mm			
	D ≤ 8	8 < D ≤ 12	12 < D ≤ 20	D > 20
for standard application	4D	5D	6D	6D
for carefully bending	2D	3D	4D	4D

Flexible Wires (HD21)

Nominale voltage to 0,6 / 1kV	Cable diameter mm			
	D ≤ 8	8 < D ≤ 12	12 < D ≤ 20	D > 20
fixed installation	3D	3D	4D	4D
freely moveable	5D	5D	6D	6D
at the entry to mobile devices and tools without mechanical load on the wiring	5D	5D	6D	6D
with mechanical load ¹	9D	9D	9D	10D
festooned as on a gantry crane	10D	10D	11D	12D
for repeated winding operations ¹	7D	7D	8D	8D
looped around via deflection pulley ¹	10D	10D	10D	10D

1) see 5.4.1 of this HD in connection with dynamic stress

Flexible Wires (HD22)

Nominal voltage to 0,6 / 1kV	Cable diameter mm			
	D ≤ 8	8 < D ≤ 12	12 < D ≤ 20	D > 20
for fixed installations	3D	3D	4D	4D
free moveable	4D	4D	5D	6D
at the entry to mobile devices and tools without mechanical load on the wiring	4D	4D	5D	6D
with mechanical load ¹	6D	6D	6D	8D
festooned as on a gantry crane	6D	6D	6D	8D
for repeated winding operations ¹	6D	6D	6D	8D
looped around via deflection pulley ¹	6D	8D	8D	8D

1) see 5.4.1 of this HD in connection with dynamic stress

**Permissible Bending Radii for Laying on 20°C (+/-10°C)
for not harmonized Wires (DIN VDE 0298-3)**

Type	Nominal voltage to 0,6/1kV			Nom.voltage over 0,6/1kV
Wires for fixed installation	Overall Diameter of the cable or of a flat cable mm			
	up to 10	from 10 to 25	over 25	
for fixed installation	4D	4D	4D	6D
for forming	1D	2D	3D	4D

Type	Nominal voltage to 0,6/1kV				Nom.voltage over 0,6/1kV
For flexible applications	Overall Diameter of the cable or of a flat cable mm				
	up to 8	from 8 to 12	from 12 to 20	over 20	
for fixed installations	3D	3D	4D	4D	6D
in motion	3D	4D	5D	5D	10D
at entry	3D	4D	5D	5D	10D
for forced bendings ¹⁾ such as					
for reeling operation	5D	5D	5D	6D	12D
for cable trolley operation	3D	4D	5D	5D	10D
for cable chains	4D	4D	5D	5D	10D
for roller guidance system	7,5D	7,5D	7,5D	7,5D	15D

¹⁾ The suitability for this operation must be ensured by special construction characteristics.

For energy cables

acc. HD 603 S1:1994/A2:2003 and HD 620 S1:1996 and HD 621 S1:1996

plastic insulated cables				paper insulated cables with lead sheath	
multicore		single-core		multicore	single-core
to 1 kV	from 1 kV	to 1 kV	from 1 kV		
12D	15D	15D	15D	15D	25D

D = overall diameter of the cable

For telecommunication cables and installation cables for telecommunications systems

Cable type	minimum bending radius in mm
Installation cable (e.g. FvYAY, FYAY, J-Y(ST)Y ect.)	7,5D
Telecommunication cable for earth laying (e.g. F-2YA2Y, A-2YF(L)2Y ect.)	10D
DA = overall diameter of the cable	

Permissible Laying Temperatures

When laying power cables the cable temperature should not fall below:

- Paper insulated cable + 5°C
- Plastic-insulated cable with PVC sheath + 5°C
- XLPE-insulated cable with PE sheath - 20°C

At lower temperatures the cables must be adequately warmed up beforehand. This can be done by storing them in a heated area (approx. 20°C) for several days or by means of special hot air equipment.

Permissible Pull-forces for Laying

When laying power cables by machine, particular attention must be paid to the permissible tensile forces:

Pulling method	Constuction of cables	Tensile force
pulling head on the conductor	all types of cables	$F = A \cdot 50 \text{ N/mm}^2$ (Cable with Cu- conductor) $F = A \cdot 30 \text{ N/mm}^2$ (Cable with Al- conductor)
with cable stocking	all wire-armoured cables (e.g. NYFGY, NAYFGY ect.)	$F = K \cdot D^2$ (K=9 N/mm ²)
	cables with metal sheath, without tension-proof armour (e.g. NKBA, NYKY, NAKLEY ect.)	$F = K \cdot D^2$ (single-sheathed cable K=3 N/mm ²)
	(e.g. NEKEBA, NAEKEBA ect.)	(3-core single lead sheath cable K=1 N/mm ²)
	plastic cables without metal sheath, plastic cables without armour (e.g. NYY, NYSY, NYSEY, NYCWY, NA2XS2Y ect.)	$F = A \cdot 50 \text{ N/mm}^2$ (Cu-conductor) $F = A \cdot 30 \text{ N/mm}^2$ (aluminium conductor)

If three single-core cables are laid simultaneously with a common cable stocking, the same max. pulling forces as they are applicable for single-core cables, are valid. For 3 laid single-core cables the calculation of the permissible pulling forces is based on 3 cables, whereas it is based on 2 cables if the 3 single-core cable are not laid-up.

A = total conductor cross-section in mm² (without screen and concentric protective conductor)

D = outside diameter of cable in mm.

Delivery and payment conditions

1. Conclusion

Our deliveries take place exclusively in accordance with the following conditions. Purchasing conditions of the customer are herewith excluded. We are not obliged by these, also if these have not been expressly excluded at the time of contractual agreement. Agreements that deviate from the following delivery and payment conditions require our written confirmation in order to become legally effective.

2. Prices

All prices detailed by us are subject to change. Prices are net and are subject to the applicable sales tax, although exclude unloading. The basis for the price calculation is our valid price list.

3. Price terms

Unless otherwise agreed, prices are ex works St. Florian. The costs for any collection are borne by the customer. The price terms include ring packaging. In the event of goods sent on drums or in boxes, point 9 applies.

4. Price basis

Prices applicable on the day of delivery apply plus sales tax.

The prices include a base copper price of EUR 130.00 per 100 kg of copper, a base price for aluminium of EUR 100.00 per 100 kg aluminium and a base lead price of EUR 50.00 per 100 kg of lead. The final prices are derived from the metal surcharges and discounts according to the metal, on our homepage (www.meinhart.at) published, (MKÖ) quotations.

5. Reservation of delivery

All delivery agreements on our part are subject to timely delivery to ourselves. Part deliveries are permissible.

Delivery excesses and shortages of up to 10% of the order quantity are possible. All data regarding diameters and weight are to the best of our knowledge; unless otherwise agreed these are non-binding and approximate. Goods are expressly subject to deviations in the construction due to fabrication or raw materials, as well as changes that do not influence the technical useability and serviceability.

6. Delivery periods

Unless otherwise expressly agreed, no fixed periods are confirmed by us. Where we are unable to meet with a delivery date for reasons which are beyond our control, the customer is initially required to confirm in writing an extension to the delivery period of a further 4 weeks. If we fail to meet with this delivery date through fault of our own, the customer is entitled to withdraw from the contract.

Our delivery periods only commence on the day upon which complete clarification of the order takes place. In the event of force majeure or unforeseen circumstances affecting the raw materials market, our delivery periods shall be halted until such circumstances have been rectified. If the interruption lasts for more than 3 months, both contracting parties are entitled to withdraw from the contract. If the delivery period should extend under the aforementioned circumstances or if we are released from delivery obligations, any entitlement to damages on the part of the customer is inapplicable.

7. Terms of payment

Our invoices are payable within 30 days of the date of invoicing without any deductions. Unless otherwise agreed, the customer is entitled to make payment within 14 days of the invoice date and deduct a 3% discount for doing so. However, discounts can only be applied if the customer is not in arrears with his remaining payment obligations.

By exceeding the 30 day payment term, the customer falls into arrears without the issuance of a reminder.

Offsetting, reductions or executing the right of retention is only permissible against our invoices where the counterclaim is legally effective or undisputed. If the customer does not comply with our delivery or payment conditions or where misgivings exist regarding punctual payment, this entitles us to withhold outstanding deliveries or make these dependent on securities or prepayment.

In the event of arrears, delayed payments are subject to interest at 3% above the Lombard rate, although a minimum 8%. We reserve the right to raise additional claims for damages. In the event of tardiness, the buyer agrees to reimburse the supplier/vendor for costs incurred during the reminder and collection process by the credit collection agency (Kreditschutzverbandes von 1870).

We shall only accept bills and cheques as payment on arrangement and without cost to us. We are not liable for punctual bill presentation and for protesting.

Irrespective of the term of any accepted and discounted bill and irrespective of the agreed payment terms, all of our demands fall payable immediately if the customer's person should encounter circumstances that reduced his creditworthiness, such as the unwarranted non-payment of an outstanding invoice for example.

8. Retention of title

8.1. Until all (also balance) payments have been received from the customer, comprising those to which we are entitled either now or in the future from the customer or his company group for any legal reason, the following securities shall be guaranteed to us. On demand we shall release our selected apportion of said securities if these exceed the value of our receivables by more than 20%.

8.2. The goods remain our property. Processing or alteration always takes place for us as supplier, although without any obligation on our part. Should our (co)ownership expire due to combination, it is hereby agreed that the co-ownership of the actual product held by the customer shall pass to us on the basis of percentage value (invoice value). The customer shall store the goods supplied by us or the (co)owned processed goods free of charge.

8.3. The customer is entitled to process and sell well subject to the retention of title (or processed goods under co-ownership) within the scope of orderly business activities if he is not in arrears. Pledging or transferring by way of security is impermissible. Any receivables arising from the goods subject to retention of title due to the onward sale or on any other legal grounds (insurance etc.) are hereby transferred to us in full by the customer for security purposes. The customer irrevocably entitles us to collect the transferred receivables in our name, whereby the costs incurred shall be borne by the customer. On request by us, the customer is required to disclose the transfer and provide us with all of the requisite information and documentation. The customer is obliged to inform us of any global or partial cessations, in particular pertaining to banks or factoring banks.

Delivery and payment conditions

- 8.4 In the event of conduct on the part of the customer which is contrary to the contract – in particular payment arrears – we are entitled to take back goods subject to the retention of title at the cost of the customer or to demand the transfer of the customer's demands to third parties arising from supply. In taking back or seizing goods subject to the retention of title we do not - unless the instalments purchase law comes into application - withdraw from the contract.
- 8.5 The customer must inform us immediately of access by third parties to goods subject to the retention of title.
- 8.6 If an agreement exists between the customer and his buyer, which states that the receivables owing to the customer from his buyer can only be transferred with the buyer's approval, then the customer is expressly obliged to inform us of this point of agreement prior to us supplying the goods. If, in this instance, the buyer refuses to grant agreement to the transferral of securities to us, we are entitled to make our delivery dependent on the provision of an agreement or to the provision of an alternative security.

9. Packaging

- 9.1 Drums from Kabeltrommel GmbH & Co KG
Drums from KTG are subject to the same conditions as those applicable to the relinquishment of cable drums from Kabeltrommel GmbH & Co KG.
- 9.2 Own drums
If KTG drums are not used then the standard cable industry conditions for the loaning of cable drums in return for a deposit and the charging of fees shall apply.

10. Transfer of risk

All risks are transferred to the customer once the goods leave our delivery depot or warehouse, or are registered as ready for shipping or collection, also if the dispatch address is not the place of fulfilment.

11. Warranties

- 11.1 Goods are only supplied which reflect the latest status of technical development. Where standards (DIN) or other specifications (VDE) exist, we supply in accordance with these.
- 11.2 On receipt the customer is required to check the delivered goods immediately. Any defects ascertained here must be detailed on the consignment and delivery notes in writing. Other defects which are not immediately apparent must be declared within 2 weeks of their initial discovery in writing. If the customer does not comply with these requirements then all warranty entitlements shall be voided. Such claims are generally excluded if more than 3 months have passed since dispatch from our warehouse. Likewise warranty claims are excluded if processing has commenced on products supplied by us, unless the defect only became apparent at the time of processing. All entitlements arising from notices of defects require that the defects be reported to us in writing immediately on discovery and that a sample (specimen section) of the goods in question be made available free of charge and non-bindingly.
- 11.3 If tests are to be carried out on goods supplied by us, these must take place prior to installation. The test must check that the characteristics required in the ÖVE specifications or any other build types agreed are in place. Voltage tests carried out on the goods supplied are deemed to be contractually compliant and correct if at least 2/3 of the random tests conducted lead to no objections. We shall bear the costs of the test if the goods are found to be unsatisfactory, otherwise the customer shall bear these. Exchanged goods are our property.
- 11.4 In the event of substantiated complaints, we shall deliver a free replacement or rectify the defect, or provide a credit note to the value of the order within an appropriate timeframe which must be no less than 6 weeks. Multiple subsequent deliveries are permissible. Instead of providing a replacement delivery we are able to guarantee the customer an appropriate discount of the purchase price due payable by him. Warranty claims apply to the customer directly, they are non-transferable. If defect rectification or a replacement delivery proves faulty within an appropriate timescale then the customer is entitled to demand a discount or withdraw from the contract.
- 11.5 In the event of point 4 occurring or where claims for damages arise due to the impracticality of the service, due to non-fulfilment, an active breach of contract, fault at the point of contractual agreement or illicit trade, all forms of claim against us, our assistants and vicarious agents are excluded unless damage is the result of malicious or gross negligence. If claims for damages arise in this instance, these are limited to 30% of the value of the goods invoiced for by us or 30% of the order value.

12. Returns

Returns must be agreed in advance and shall be subject to processing fees.

13. Place of fulfilment and jurisdiction

The law of the Republic of Austria shall govern these terms and conditions as well as the entire legal relationship between the customer and ourselves.

Where legally permissible and where our contracting partner is the general merchant, Steyr shall hold sole jurisdiction for all disputes arising directly and indirectly from the contractual relationship.

Should one of the previous conditions prove void, this shall not affect the validity of the remaining conditions. Further to these conditions, the general terms of delivery for products and services from the electrical industry also apply.

Metal surcharges

			2009			2010		
			Cu	Al	Pb	Cu	Al	Pb
1st quarter	Metals							
	CW 1	EUR						
	CW 2	EUR						
	CW 3	EUR						
	CW 4	EUR						
	CW 5	EUR						
	CW 6	EUR						
	CW 7	EUR						
	CW 8	EUR						
	CW 9	EUR						
	CW 10	EUR						
	CW 11	EUR						
2nd quarter	CW 12	EUR						
	CW 13	EUR						
	CW 14	EUR						
	CW 15	EUR						
	CW 16	EUR						
	CW 17	EUR						
	CW 18	EUR						
	CW 19	EUR						
	CW 20	EUR						
	CW 21	EUR						
	CW 22	EUR						
	CW 23	EUR						
3rd quarter	CW 24	EUR						
	CW 25	EUR						
	CW 26	EUR						
	CW 27	EUR						
	CW 28	EUR						
	CW 29	EUR						
	CW 30	EUR						
	CW 31	EUR						
	CW 32	EUR						
	CW 33	EUR						
	CW 34	EUR						
	CW 35	EUR						
4th quarter	CW 36	EUR						
	CW 37	EUR						
	CW 38	EUR						
	CW 39	EUR						
	CW 40	EUR						
	CW 41	EUR						
	CW 42	EUR						
	CW 43	EUR						
CW 44	EUR							
CW 45	EUR							
CW 46	EUR							
CW 47	EUR							
CW 48	EUR							
CW 49	EUR							
CW 50	EUR							
CW 51	EUR							
CW 52	EUR							

Metal surcharges

			2011			2012		
Metals			Cu	Al	Pb	Cu	Al	Pb
1st quarter	CW 1	EUR						
	CW 2	EUR						
	CW 3	EUR						
	CW 4	EUR						
	CW 5	EUR						
	CW 6	EUR						
	CW 7	EUR						
	CW 8	EUR						
	CW 9	EUR						
	CW 10	EUR						
	CW 11	EUR						
	CW 12	EUR						
	CW 13	EUR						
2nd quarter	CW 14	EUR						
	CW 15	EUR						
	CW 16	EUR						
	CW 17	EUR						
	CW 18	EUR						
	CW 19	EUR						
	CW 20	EUR						
	CW 21	EUR						
	CW 22	EUR						
	CW 23	EUR						
	CW 24	EUR						
3rd quarter	CW 25	EUR						
	CW 26	EUR						
	CW 27	EUR						
	CW 28	EUR						
	CW 29	EUR						
	CW 30	EUR						
	CW 31	EUR						
	CW 32	EUR						
	CW 33	EUR						
	CW 34	EUR						
	CW 35	EUR						
	CW 36	EUR						
4th quarter	CW 37	EUR						
	CW 38	EUR						
	CW 39	EUR						
	CW 40	EUR						
	CW 41	EUR						
	CW 42	EUR						
	CW 43	EUR						
	CW 44	EUR						
	CW 45	EUR						
	CW 46	EUR						
	CW 47	EUR						
	CW 48	EUR						
	CW 49	EUR						
	CW 50	EUR						
	CW 51	EUR						
	CW 52	EUR						

Westbahnstraße 6
A-4490 St. Florian
Tel. 07224/690 Serie
Fax 07224/690 DW 612 / 614

